

P23049	Champagne	P23063	Silver	P64077	Purple	S23459	Orange
--------	-----------	--------	--------	--------	--------	--------	--------

⚠ General Safety Warning ⚠

Please make sure that you read and follow these instructions carefully. Failure to do so can result in injury. Keep these instructions in a safe place for future reference.

1.0 INTENDED USE

The Freestyle is a lightweight aluminium rollator designed to give support and aid to those who cannot, or who lack the confidence to, walk without some level of guidance. This rollator is intended for indoor and outdoor use.



Figure 1: Freestyle Rollator

2.0 SAFETY

The maximum user weight must not be greater than 18st / 115kg.

Make sure that the rollator is locked in the open position before use, see section 4.1.

Only use as a walking aid in the forward direction.

Do not make adjustments to the rollator unless it is stationary.

Do not use on stairs or escalators and take care on steep hills.

Do not hang items from the handles as this will affect the stability of the rollator.

The maximum load weight for the rollator bag must not be greater than 5kg.

Maximum User Weight



Figure 2: Parts

3.0 UNPACKING

1. Refer to Figure 2. Remove the packaging and check all parts carefully. Contact your supplier immediately if parts are missing or damaged and do not try and assemble.

Contents:

1. Main Frame & Front Wheel x 1
- 2a. RHS Handle & 2b RHS Rear Wheel x 1
- 3a. LHS Handle & 3b LHS Rear Wheel x 1
4. Bag (P23051) x 1
5. Handwheel x 2
6. Handwheel Bolts x 2

4.0 ASSEMBLY

4.1 Unfold the Rollator:

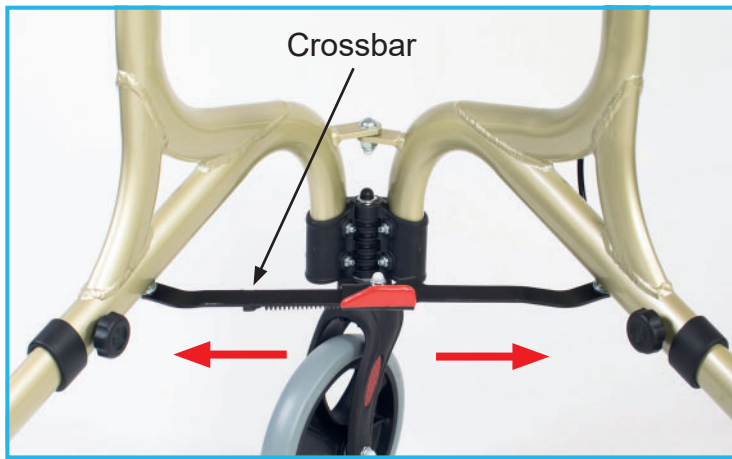

Figure 3: Unfolding the Rollator

1. Refer to Figure 2 and Figure 3. Gently pull the main frame apart until the spring locks the crossbar open.

4.2 Attach the Wheels:



Figure 4: Attach the Wheels

1. Refer to Figure 2 and Figure 4. Slot the RHS wheel frame tube into the RHS main frame tube.
Note: The rear wheel brake mechanism must face the external side of the rollator.
2. Align the holes and insert a handwheel bolt.
3. Make sure that the handwheel bolt has located into the hexagonal slot.

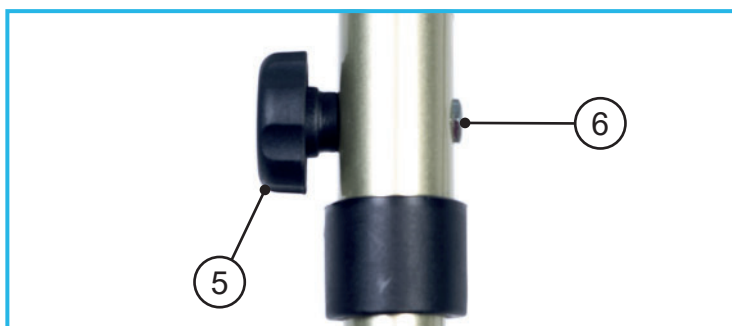

Figure 5: Attach the Handwheel

4. Refer to Figure 5. Attach the handwheel (item 5), to the handwheel bolt (item 6) and tighten.
Note: Make sure that the handwheel is located on the internal side of the frame.
5. Repeat for the other wheel.

4.3 Attach the handles:

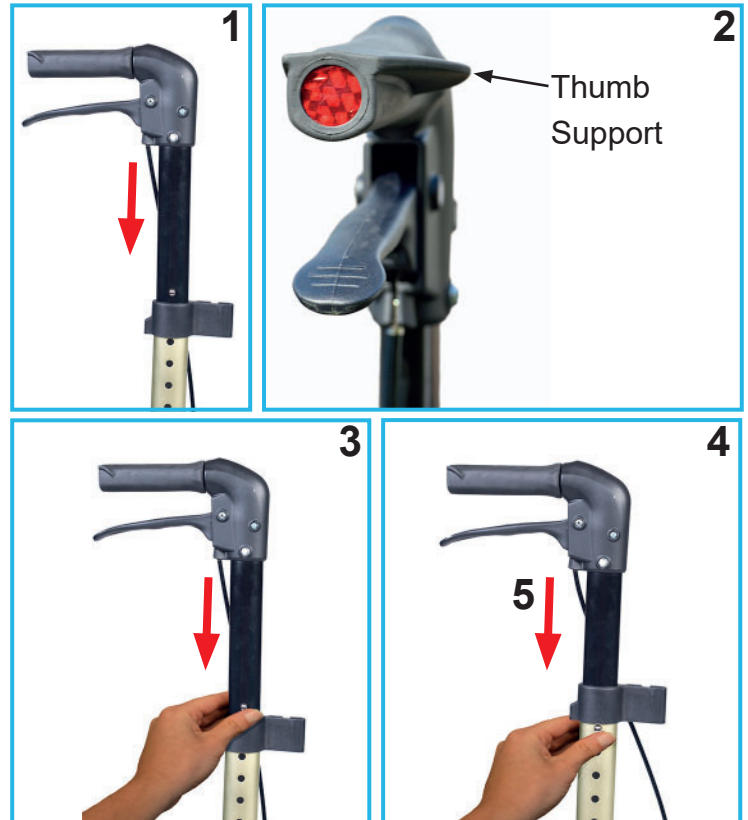

Figure 6: Attaching the Handles

1. Refer to Figure 2 and Figure 6. Slot the RHS handle tube into the RHS tube of the main frame.
2. Make sure that the thumb support on the handle is facing the internal side of the rollator.
3. Push and hold the handle button-clip, then push the handle until the button-clip clicks into position in the first hole.
4. Adjust the height of the handle to the correct height. The handle position should line up with your wrists, in a standing position, with your arms relaxed by your side.
Note: The range of the handle adjustment is in 25mm increments, from 820mm to 920mm.
5. To adjust the handle, push and hold the button-clip, then lower to the required height. Allow the button-clip to click into the nearest adjustment hole to secure.
Note: Make sure that the button-clip has fully engaged into the hole.
6. Repeat for the other handle.

4.4 Fix the Brake Cable:



Figure 7: Attaching the Brake Cables

1. Refer to Figure 7. Push the brake cable into the clips at the top of the main frame.

4.5 Fitting the Bag:

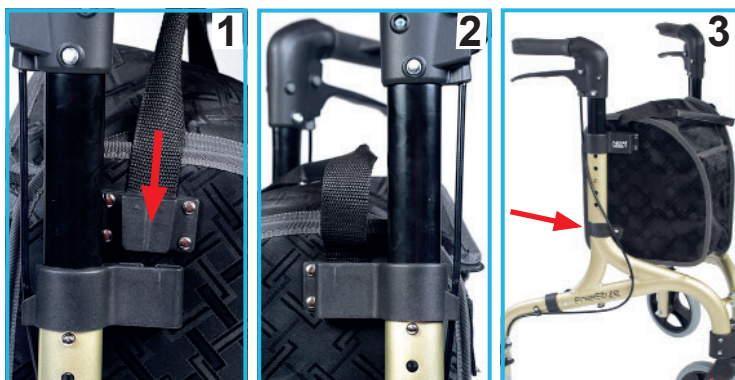

Figure 8: Fitting the Bag

1. Refer to Figure 8. Slot one of the 'T-brackets' on the side of the bag into the slot at the top of the main frame.

Note: The bag pockets must be positioned at the rear of the rollator, facing the user.

2. Repeat on the other side of the bag.
3. Secure the bag with the safety strap.

5.0 IN USE

5.1 Operating the Brakes:

 The brakes must be checked before first use, failure to do so can result in injury.

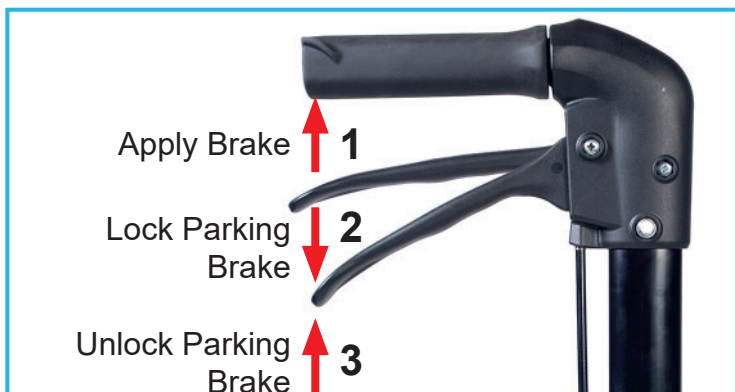

Figure 9: Operating the Brakes

5.2 Apply the Brake:

1. Refer to Figure 9. Squeeze the brake lever up to apply the brake. Let go of the lever to release the brake.

Note: The brakes are operated independently.

5.3 Locking the Parking Brakes:

2. Refer to Figure 9. Push the brake lever down until it locks into position.

5.4 Unlocking the Parking Brakes:

3. Refer to Figure 9. Pull the brake lever up. An audible click will be heard as the brake is released.

Note: To adjust the brakes, refer to Section 7.1.

5.5 Folding the Rollator:

1. Refer to section 4.5 and Figure 8. Release the bag security strap, then remove the bag by lifting it up with the handle. The 'T-brackets' should slide free from the bag slots on both sides.

Note: If the bag is empty it does not need to be removed prior to folding.



Figure 10: Folding the Rollator

2. Refer to Figure 10. Gently, push the cross-bar forwards to release the spring lock.
3. Push the handles together to fold the rollator.

6.0 CLEANING

1. Make sure that all dirt and debris is removed from around the wheels, axle and brakes.
2. To clean the bag wipe with a damp cloth. Do not machine wash.
3. Clean the frame regularly, using a general purpose, neutral detergent and warm water.
4. Please check the suitability of the cleaning products before use. Do not use abrasive cleaners or cloths as these could permanently damage the surface and invalidate any warranty.
5. Always allow the product to dry thoroughly prior to use or storage.

7.0 Maintenance

! Please contact your supplier if you require assistance with the maintenance of the rollator. Incorrect adjustments can result in serious injury.

1. Check all button clips are fully clicked in position and that both hand wheels are tight and secure.
2. Check the wheels can rotate freely.
3. Check for general wear or damage. Any suspected faults or damage should immediately be reported to the supplier and the product taken out of use.
4. Make sure the brakes are functioning correctly. When the brake levers are squeezed, the two rear wheels should not be able to rotate.

7.1 Adjusting the Brakes:

! The following section requires some technical ability, do not attempt to carry out the adjustment unless you are confident to do so.

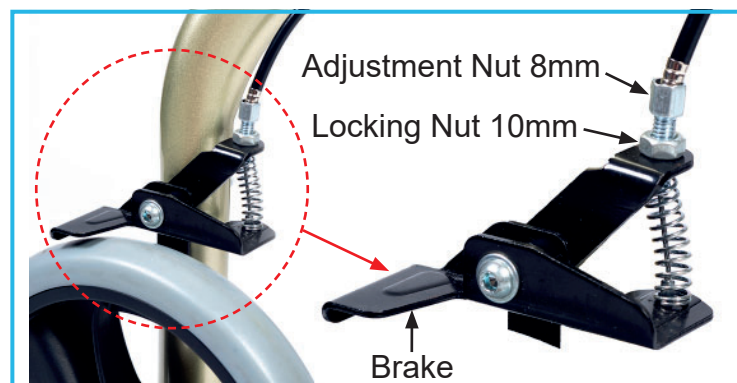

Figure 11: Adjusting the Brakes

1. Refer to Figure 11. The brake adjustment nut is located at the bottom of the brake cable, above the rear wheel on both sides.
2. Use a 10mm spanner to loosen the locking nut in an anti-clockwise direction.
3. Use an 8mm spanner to adjust the brake tension. To tighten the brakes, turn the adjustment nut in an anti-clockwise direction.

Note: There must be a small gap between the brake mechanism and the wheel, when the brake lever is released.

4. Use a 10mm spanner to tighten the locking nut in a clockwise direction.

Note: Use the 8mm spanner to make sure the adjustment nut remains in position, while tightening the locking nut.

5. Test the brakes in accordance with Section 5.1.

Note: Incorrectly adjusted brakes can lead to injury, please contact head office if you require assistance.

8.0 ACCESSORIES & SPARE PARTS

P23051 Replacement Bag

For more details please visit our website or call Customer Services on the details below.

9.0 PRODUCT DISPOSAL

This product should be thoroughly cleaned prior to disposal.

This product is manufactured from metal and plastic and can be disposed of through Local Authority Household Waste and Recycling Centres or through Local Trade Waste Collectors.

10.0 PRODUCT GUARANTEE

NRS Healthcare guarantee this product for a period of 12 months, from the date of purchase, against faulty materials and workmanship. This guarantee does not cover; abuse, misuse, interference or tampering with any part of the product.

Any guarantee issued by NRS Healthcare does not affect your statutory rights.

**UK
CA** NRS HEALTHCARE Sherwood House,
Cartwright Way, Forest Business Park, Bardon
Hill, Coalville, Leicestershire, LE67 1UB, UK.

CE NRS HEALTHCARE 4C Altona Road, Blaris
Industrial Estate, Lisburn, Co Antrim,
Northern Ireland BT27 5QB

Tel: Customer Services: 0345 121 8111

Email: customerservice@nrshealthcare.co.uk

NRS Healthcare is a leading supplier of community equipment and daily living aids.
Please visit one of our websites to view our full range of products:
www.healthcarepro.co.uk or www.completecareshop.co.uk