



# Leckey Therapy Bench

User Manual



Supporting  
Children



# CONTENTS

01 Intended Use	p.03
02 Certification	p.04
03 Warnings and Cautions	p.05
04 Terms of Warranty	p.06
05 Safety Information	p.07
06 Precautions And Contraindications	p.08
07 Cleaning & Care Information	p.09
08 Product Inspection and Servicing	p.10
09 Important Guidelines	p.10
10 Re-issuing Leckey Products	p.11
11 Instructions for Use	p.12
12 Sizing Information	p.21

---

## SECTION 01: INTENDED USE

### Intended use

The Leckey Therapy Bench is intended to facilitate therapy carried out by qualified therapists on children and adults with disabilities in dedicated therapy settings.

### Indications for use

The Leckey Therapy Bench is indicated for use by qualified therapists as an adjunct to their therapeutic intervention for children with moderate to severe disability. Utilised alongside the innovative activity cradle, trunk support and therapist's pad, the Leckey Therapy Bench assists in achieving and maintaining a neutral sitting posture, supporting the child whilst freeing up the therapist's hands to facilitate greater engagement and child active therapy. It can also be used to complete a validated therapy assessment of sitting ability - the Segmental Assessment of Trunk Control (SATCo). The Leckey Therapy Bench is designed for the age range of 1-14 years and with a maximum user weight of 80kg.



**Warning – Children should not be left unattended/unsupervised on Leckey Therapy Bench at any time, as they could be at risk of falling or injuring themselves.**

## SECTION 02: CERTIFICATION

The Leckey Therapy Bench is classified as a Class I Medical Device under EU and UK regulations. As the manufacturer, James Leckey Design Limited, declares that this product conforms to the Medical Device Regulation (2017/745), UK Medical Device Regulations 2002, Medical Device Directive (93/42 EEC) and EN 12182:2012 Assistive products for persons with disability, general requirements and test methods.

**Notice to the user and/or patient: Any serious incident that has occurred in relation to the device should be reported to the manufacturer and the competent authority of the Member State in which the user and/or patient is established.**



**NOTE: General user advice.**

Not following these instructions may result in physical injury, damage to the product or damage to the environment!

## **SECTION 03: WARNINGS AND CAUTIONS**

### **1) WARNING FINGER TRAP HAZARD**

- Take care that the fingers of the operator or children on the floor do not get trapped in the Leckey Therapy Bench adjustment.

### **2) WARNING OCCUPANT SECURITY**

- Ensure that the pelvic cradle is fastened and adjusted to hold the occupant securely in place before using the Leckey Therapy Bench or leaving the vicinity of the static seat.

### **3) CAUTION FINGER PINCH HAZARD**

- Take care when assembling or adjusting the position of the seat components that your fingers do not get pinched when positioning and tightening bench components.

### **4) CAUTION CLEANING**

- Clean the Leckey Therapy Bench regularly to prevent the build-up of dirt. Accumulated dirt can prematurely wear the seat cushions and encourage corrosion on the support. Only use non-abrasive household cleaners and moist cloths, see section, Cleaning & Care Information.

### **5) CAUTION DISPOSAL**

- Only dispose of the Leckey Therapy Bench system in a community waste disposal site.

### **6) CAUTION BRINGING INTO USE**

- When bringing the product into use from storage, allow it to acclimatise to ambient temperature for 2 hours first. Wipe off any moisture that has condensed on the product.

## **SECTION 04: TERMS OF WARRANTY**

The warranty for Leckey Therapy Bench applies only when the product is used according to its intended use, following all manufacturer's specifications. A one year warranty is provided with this James Leckey Design Ltd. manufactured product.

Goods can be returned to us for warranty, repair or replacement up to 12 months from receipt. Once you contact us, we will arrange collection of the goods at our expense and, once returned to us we will repair or replace goods and return them to you within 14 days. In all cases, it is the customers' responsibility to ensure the goods being returned are suitably packaged, preferably in the original packaging.

## **SECTION 05: SAFETY INFORMATION**

1. Always read user instructions fully before use.
2. Children should not be left unattended/unsupervised at any time in this product.
3. Check that all of the Leckey Therapy Bench components are securely assembled according to user instructions before use. Leckey Therapy Bench must only be used and placed on a firm, solid, static surface. Never use Leckey Therapy Bench on a sloping surface.
4. The maximum user weight for Leckey Therapy Bench is 80kg (176 lbs). This should never be exceeded.
5. Leckey Therapy Bench contains parts which could present a choking hazard to small children. Check all components are tight and securely fastened before use – including toggles and straps.
6. Do not modify Leckey Therapy Bench or use components other than Leckey approved components with Leckey Therapy Bench at any time. This may put the users at risk and may also invalidate your warranty.
7. Clean the product regularly in accordance with Section 07 of this user manual.
8. Complete maintenance checks on a regular basis to ensure your product is in good working condition. Leckey Therapy Bench should not be used if any of the parts are faulty.
9. If you are in any doubt about the safe use of the Leckey Therapy Bench, or if any parts should fail, please cease using the product immediately and contact Leckey customer services on UK 0800 318265 or ROI 1800 626020.
10. Any promotional items supplied with Leckey Therapy Bench should not be used unsupervised.
11. Leckey products comply with fire safety regulations in accordance with EN12182. However the product contains plastic components and therefore should be kept away from all direct sources of heat including naked flames, cigarettes, electric and gas heaters.
12. Do not place hot objects greater than 40°C.

## **SECTION 06: PRECAUTIONS AND CONTRAINDICATIONS**

### **Precautions**

- Fixed spinal deformities such as scoliosis or kyphosis
- Severe muscle contractures
- Severe muscular or skeletal asymmetry including hip dislocation
- Progressive and muscle wasting conditions
- High risk or recent history of bone fractures
- High risk of pressure related injury or open sores
- Strong, uncontrolled movement patterns
- Poorly controlled seizure activity
- Children dependent on the use of percutaneous endoscopic gastrostomy
- Medical instability including compromised respiratory or cardiovascular function
- Dependant on 3rd party life-sustaining apparatus such as oxygen tanks
- Significant learning disabilities and/or behavioural issues

### **Contraindications**

There are no contraindications associated with the use of the Leckey Therapy Bench.

All precautions and contraindications are taken at the discretion of the prescribing clinician or parent. Leckey recommends a trained and experienced clinician to be present during all initial assessment, set ups, configurations and reissues in order to minimise risk.



## SECTION 07: CLEANING & CARE

### How to Maintain:

- When cleaning Leckey Therapy Bench we recommend that you use only warm water and a non-abrasive detergent. Never use organic solvents or dry cleaning fluids.
- Do not machine wash or steam clean Leckey Therapy Bench foam components as it may cause the foam to lose shape and warp.

### Activity cradle:

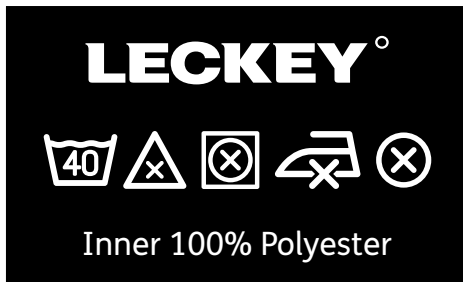

Ensure the activity cradles are completely dry before their next use.

### Height Adjustable Legs and Height adjustable Footrest:

1. Ensure the bottom of the Leckey Therapy Bench base unit is cleaned after every use to ensure it has the best level of grip on the floor and for the user.
2. Soap and water can be used for daily cleaning.
3. Do not use solvents to clean the Leckey Therapy Bench.
4. Ensure all surfaces are completely dry before their next use.

### Seat Base, Therapy Back Support:

1. Soap and water or antibacterial spray can be used for daily cleaning.
2. Ensure the vinyl covers are completely dry before their next use.
3. Ensure all vinyl covers are not damaged before their next use.

## **SECTION 08: PRODUCT INSPECTION AND SERVICING**

**We recommend that various checks of Leckey Therapy Bench are carried out before use to ensure the product is safe.**

The recommended checks are listed below:

1. Ensure that the Leckey Therapy Bench therapy back support and seat base have been fitted securely together as detailed in Section 11 of this manual.
2. Check that the Height Adjustable legs, Height Adjustable footrest and Therapy Back Support are fixed correctly at the desired heights/ depths and ensure the Leckey Therapy Bench is stable and secure before placing the user on.
3. Ensure the Activity cradle is securely fixed to the Leckey Therapy Bench before placing the user in.
4. Check the Activity cradle and seat base and therapy back supports for any signs of wear or tear.
5. Check the buckles and toggles for cracks or damage.

## **SECTION 09: IMPORTANT GUIDELINES**

Ensure that Leckey Therapy Bench is sitting securely on the ground. Adjust the Therapy back support into a position that does not hinder the placing of the user onto the product.

We would advise you place the Activity cradle open on the seat base before you place the child onto the bench. This can be adjusted if necessary, once the user is in the position. Please exercise caution and monitor the user closely whilst alterations are being made to the Activity cradle.

Lifting a user on and off of the Leckey Therapy Bench is an activity which could cause injury to your back. We would recommend you seek advice from your therapist with regards to safe lifting (manual handling techniques) for users on and off of the Leckey Therapy Bench.



If you are in any doubt about the safe use of your Leckey product or if any parts should fail, please cease using the product and contact our customer services department as soon as possible.

## **SECTION 10: RE-ISSUING LECKEY PRODUCTS**

Before re-issuing a product, it is recommended that it is disinfected using one of the following procedures:

***Note: Always clean the product first to remove accumulated soiling prior to disinfecting/sanitising.***

1. Where possible, we recommend the use of an automated “fogger” disinfection system that is used to completely cover the product surfaces with a disinfectant agent. The manufacturer’s instructions for the chosen system should be referred to prior to use and followed exactly.
2. Where an automated disinfection system is not available, all product surfaces should be wiped over with disinfectant surface wipes or liquid disinfectant on a soft cloth. Suitable products are 70% IPA, 70% Alcohol or diluted bleach. The manufacturer’s instructions for the chosen product should be followed. Product upholstery and fabrics should be cleaned thoroughly in accordance with section, Cleaning and Care Information, of this manual.

Ensure a copy of the user manual is supplied with the product.

If in any doubt about the continued safe use of your Leckey product or if any parts should fail, please cease using the product and contact our customer service department as soon as possible on: **hello@leckey.com**

# SECTION 11: INSTRUCTIONS FOR USE

## 11.1 Before Use

- Ensure the bench is placed on a firm, solid, static surface. Check the bench for any markings/damage before use.
- The Leckey Therapy Bench must be assembled correctly and set up to the correct size before use.
- Make sure the Leckey Therapy Bench and Activity cradle are clean, dry and free from anything that may cause harm to the user before use.

## 11.2 Set Up

- Before set up, take measurements of the child that will aid the positioning in supine of the footplate and seat base heights. Measure from floor to knee to dictate footplate height. **A** Measure the hip for Activity Cradle, Asis to Asis **B** and Hip circumference. **C**

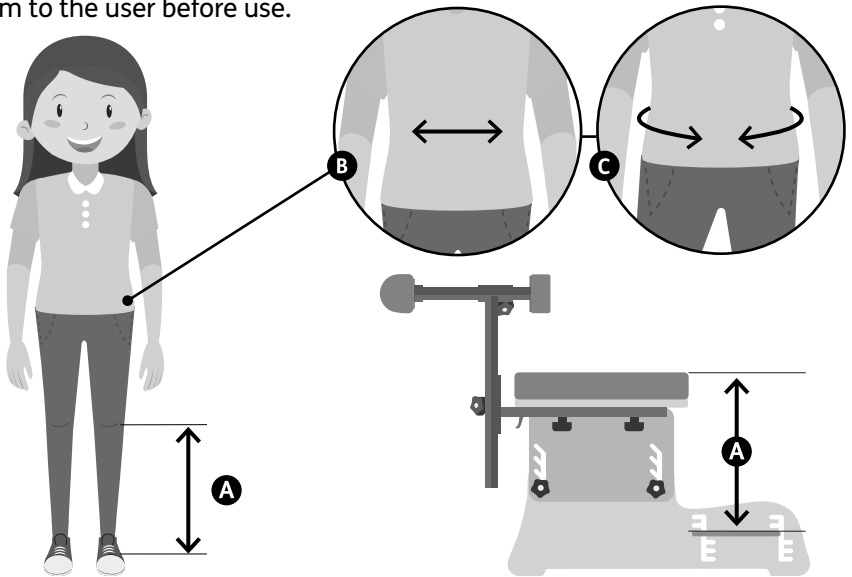

**Tip** – For the smallest of users – adjust the seat base height to the lowest position and the footplate to the highest.

For the largest of users – adjust the seat base height to the highest position and the footplate to the lowest.

## 11.3 Adjusting the seat base height

The seat base height can be adjusted to accommodate the leg length of the users, allow self-transfer for the user and for storage.

- To adjust the Leckey Therapy Bench seat base height, simply loosen the four knurled knobs on the inner surfaces of the bench - two on each bench leg. **A**

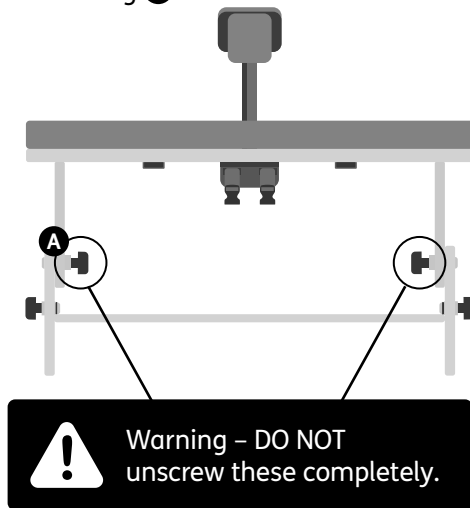

- Gripping the bench at either end, lift the seat base and slide to the desired height. **B** Ensure that the seat base has slotted into the desired position resulting in the bench being level at all four points before re-tightening all four knurled knobs securing the seat base in place. **C**

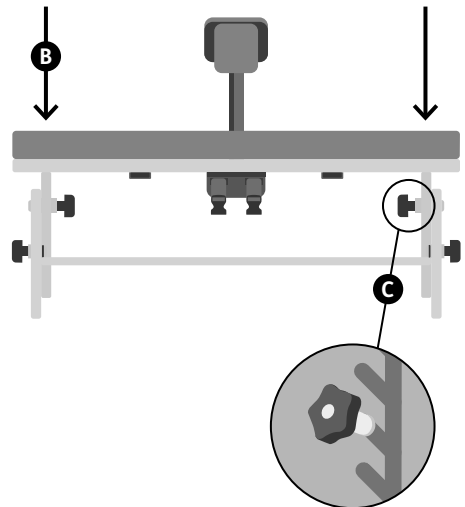

Warning – NEVER adjust the seat base height when the user is on the Leckey Therapy Bench.

## 11.4 Adjusting the seat base height and angle

The seat base can be angled both laterally and anteriorly/posteriorly accommodating any deformities (e.g. scoliosis) or aiding tilts of the pelvis.

- To angle the bench laterally, secure one side of the bench seat base in place by tightening the two knurled knobs on one side, **A** before adjusting the other side of the bench to the desired position resulting in the seat base being higher on one side than the other. **B**

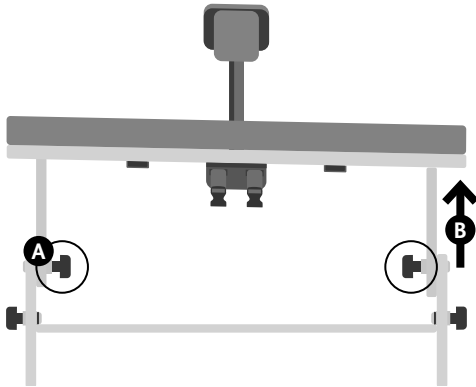

Warning – DO NOT tilt the bench laterally more than **two slot** positions higher or lower than that in relation to the other – this is equivalent to **5 degrees**. Beyond this, the bench stability and therefore safety is being exceeded.

- To angle the bench posteriorly/ anteriorly, tighten the two knurled knobs nearest the back of the bench in place, before adjusting the two front knurled knobs in the desired position resulting in the seat base being higher or lower at the front in comparison to the rear. **C**

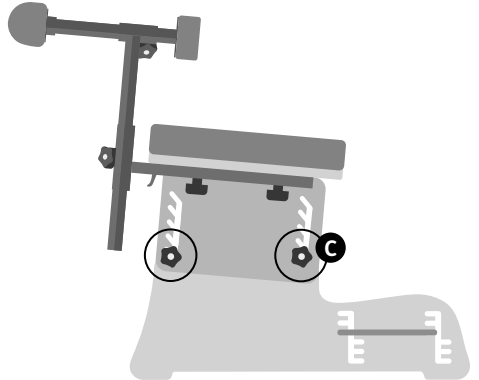

Warning – DO NOT tilt the bench posteriorly/ anteriorly more than **two slot** positions higher or lower than that in relation to the other – this is equivalent to **5 degrees**. Beyond this, the bench stability and therefore safety is being exceeded.

Warning – NEVER adjust the seat base height when the user is on the Leckey Therapy Bench.

## 11.5 Adjusting the footplate height

The footplate can be height adjusted for varying leg length, aid stability of the bench and for storage.

- To adjust the Leckey Therapy Bench footplate height, simply loosen the four knurled knobs on the outer surfaces of the bench nearest the front – two on each bench leg. **DO NOT** unscrew these completely. **A**
- Using the two slots at either end of the footplate, slide the footplate up or down to the desired height. Ensure that the footplate has slotted into the desired position at all four points before re-tightening all four knurled knobs. **B**

- If the footplate is not needed, lower the footplate to its lowest position and secure in place.
- The footplate can be completely removed if needed.



Due care and attention must be taken when adjusting the footrest with the user on the Leckey Therapy Bench.

It is highly recommended that the footrest is adjusted before the user is placed into the product.

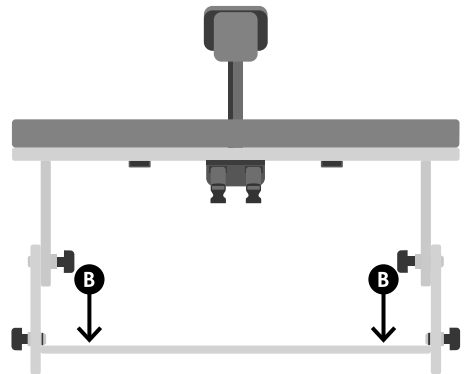
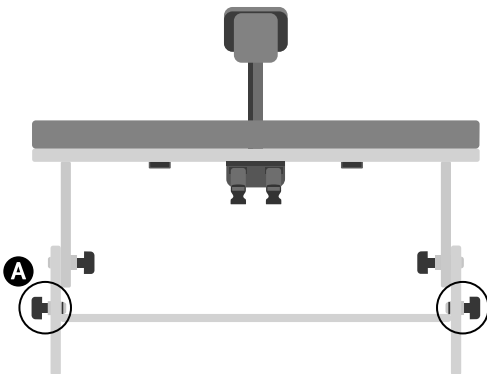

## 11.6 Attaching the back support

The back support can be attached to the Leckey Therapy Bench to aid therapists with controlling the posture of the user, helping remedy kyphosis and aiding to keep the child more upright.

Two pads are present of the back support:

- 1. Therapist Pad** – This allows the therapist to lean against the support to gain better control of the user whilst also increasing the therapist’s own stability whilst doing so.
- 2. User Pad** – This is a more rounded pad that allows for easy targeting to smaller areas of the user’s back/spine.

- To attach the back support, insert two knurled knobs through the bottom arm of the back support and screw into the two plates present on the underside of the seat base. **A**
- To remove the back support, simply unscrew the two knurled knobs present on the underside of the seat base.

 Due care and attention must be taken when attaching or removing the back support with the user present on the Leckey Therapy Bench.

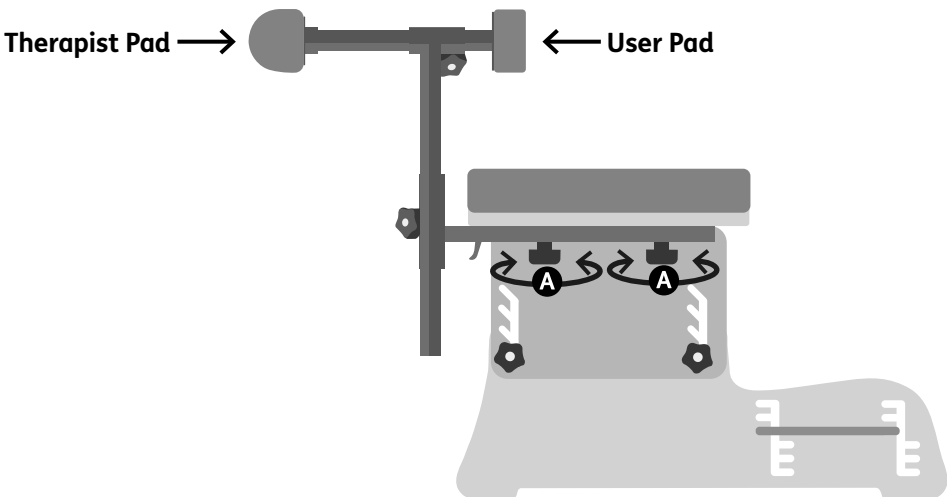



## 11.7 Attaching user in activity cradle and the activity cradle to the seat base

There are 4 straps which secure the activity cradle to the bench. Two straps have no buckle and come from the side and attach to the back. The other two buckle straps come from the back corset of the cradle and attach to the front of the bench.

1. Place the activity cradle open and flat in the middle of the bench. Use central stitch line as a guide.
2. Open the two cam-locks, thread underneath of the bench and the non-buckle straps through each cam-lock. **A** Make sure the straps are locked down and not twisted. **B** You may need to adjust the length once the child is in position.

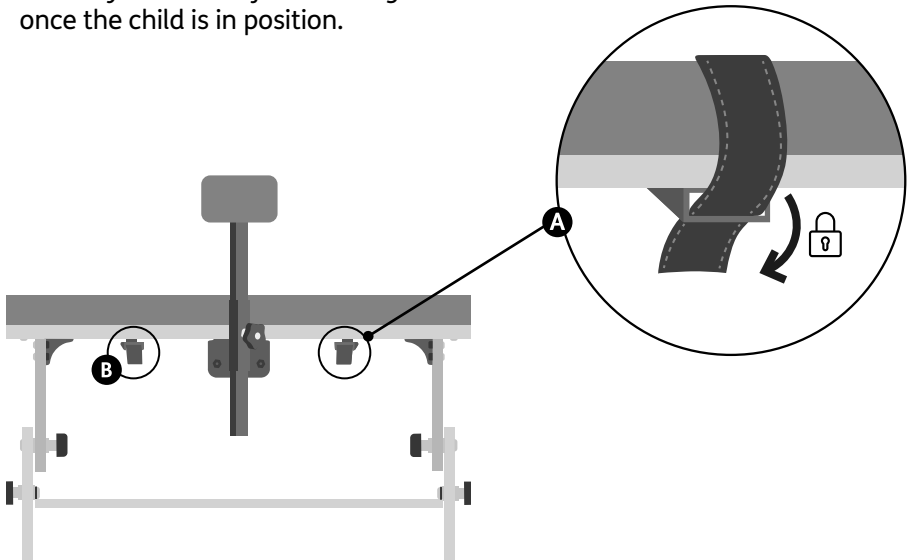
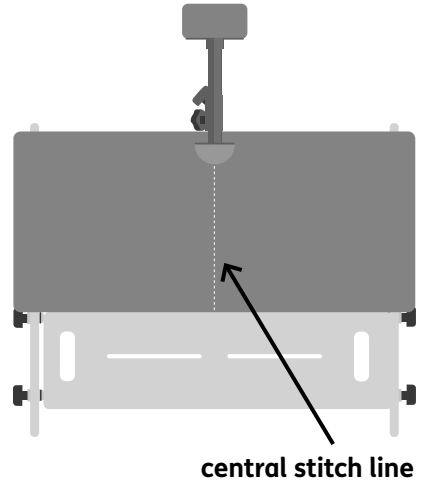

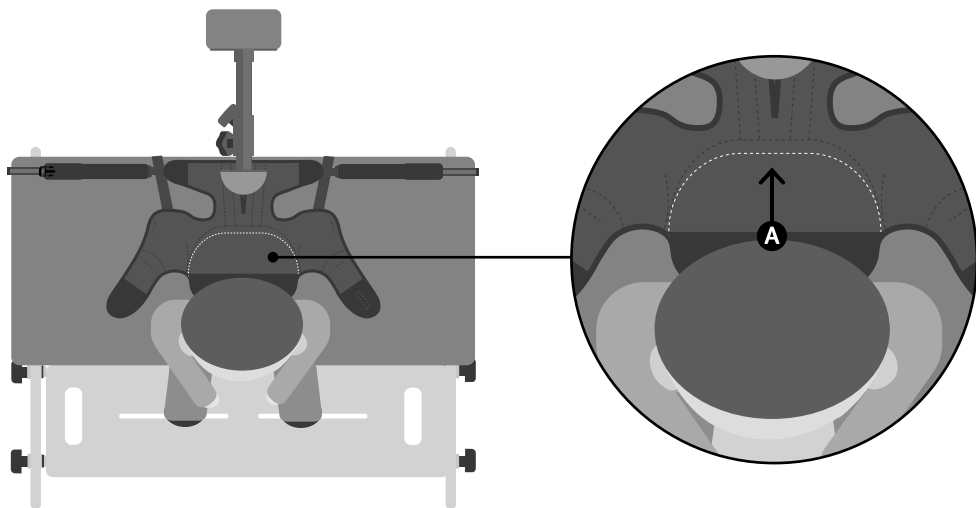

3. Place the child back into the cradle with their bottom over the white stitched line. **A**

---

4. Fasten the front velcro pad **A** and the front strap around the child's tummy. **B**

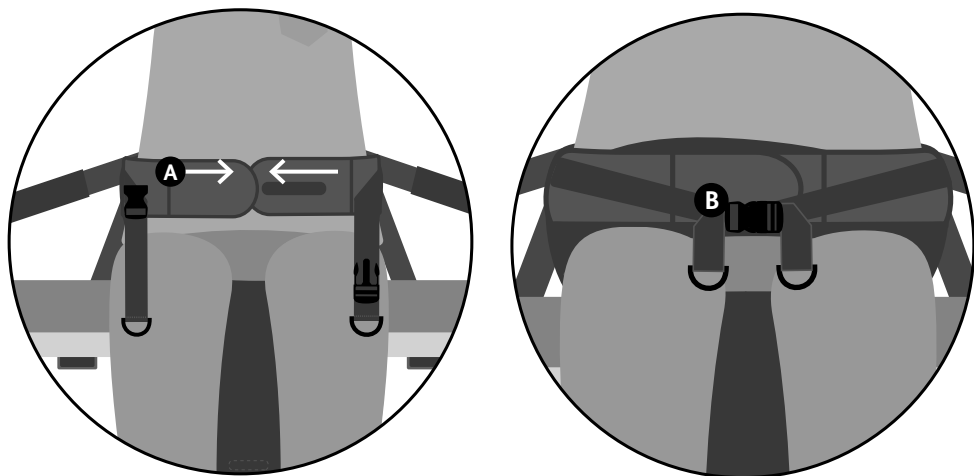

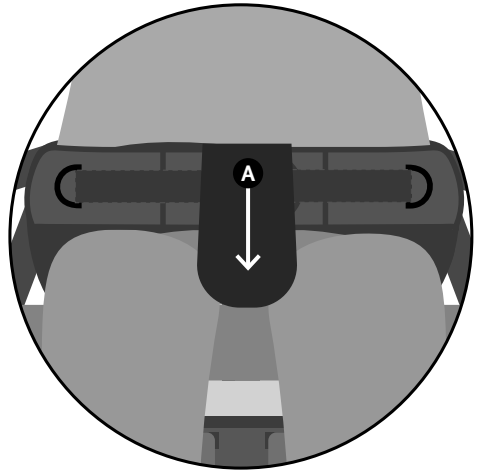
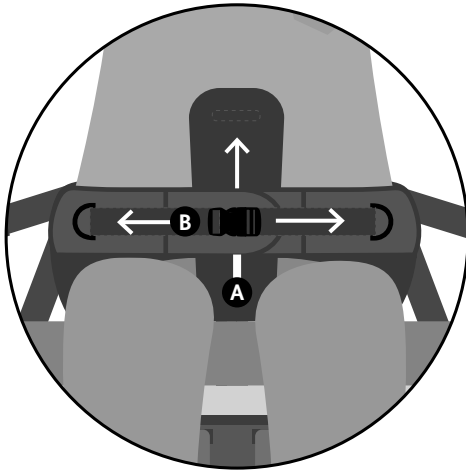

5. Thread the padded central strap between the front buckle and the child **A** and tighten the buckle securely. **B** The strap should be fastened tightly allowing for two finger spaces between cradle and child.

6. Fold over the added central strap so that the buckle is now hidden. **A** This material will protect the child from direct contact

7. Come around the back of the child and secure each side velcro flap around the child. **A**

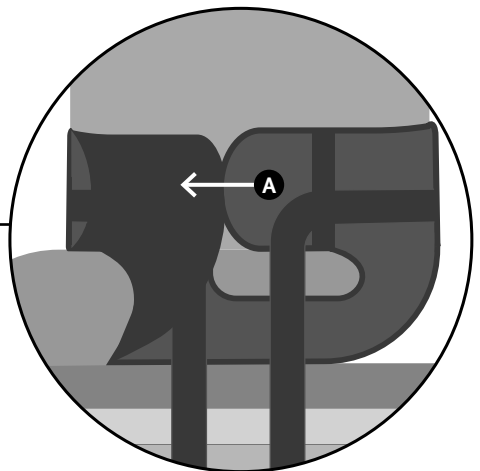
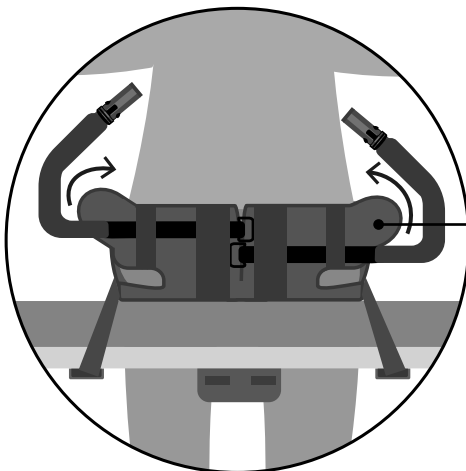

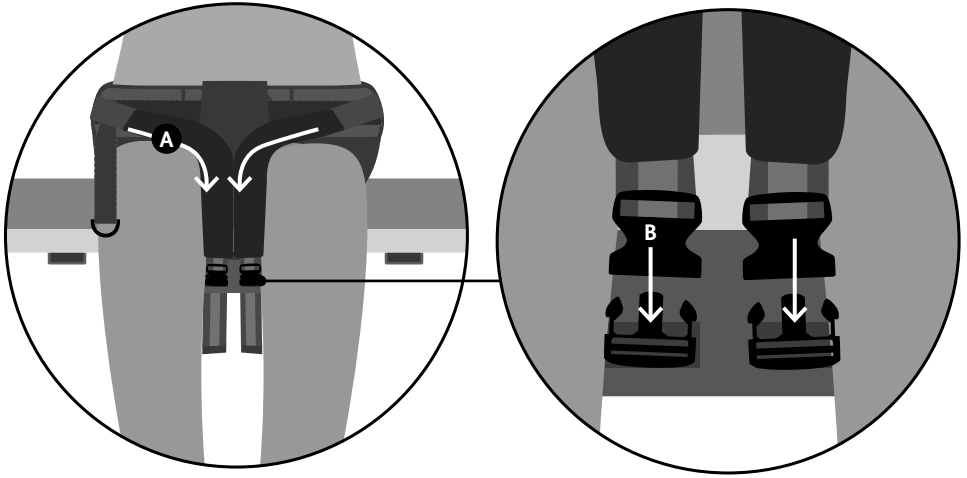

8. Take hold of the two large buckle straps which come from the rear of the corset. Pull them over the child's inner thigh **A** and secure to the buckles at the front of the bench. **B**

 The harness should be tight and hold pelvis in neutral.

9. Pull each buckle strap to tighten the corset, **A** securing the child and ensuring the child is sitting with neutral pelvis.

**You are now ready to assess or play with the child.**













## SECTION 12: SIZING INFORMATION







Technical Details	
Max User Weight	80kg
Age	1-14
Bench Footprint	620mm x 740mm
Seat Base Height (from ground)	Min 330mm Max 460mm
Seat Base Width	620mm
Seat Base Depth	360mm
Footplate Height (from ground)	Min 20mm Max 110mm
Seat Base to Footplate Height	Min 220mm Max 440mm

Activity Cradle Size Guide				
Cradle Size	Hip Circumference (mm)		ASIS - ASIS (mm)	
	Min	Max	Min	Max
Size 1	400	500	Under 120	
Size 2	440	575	130	160
Size 3	520	650	160	180
Size 4	600	740	190	200
Size 5	660	855	Over 200	

For more information please  
visit **leckey.com**

## TABLE OF SYMBOLS

Symbol	Meaning
	Medical Device
	Read the Instructions for Use
	CE mark
	Warning
	Manufacturer
	Serial number
	Product code
	Max occupancy weight
	Date of Manufacture
	For indoor use only
	Latex free

Symbol	Meaning
	Unique Device Identification
	Machine wash- water temperature 40°C
	Machine wash- water temperature 60°C
	Do not iron
	Do not bleach
	Do not dry clean
	Dry clean- any solvent except tetrachlorethylene



**USA Distributor**

Sunrise Medical (US) LLC  
2842 N Business Park Avenue  
Fresno, CA 93727

[sunrisemedical.com](http://sunrisemedical.com)

T: 1-800-333-4000  
F: 1-800-300-7502  
E: [customseating@sunmed.com](mailto:customseating@sunmed.com)

**Canadian Distributor**

Sunrise Medical  
237 Romina Drive, Unit 3,  
Concord, ON, L4K 4V3

[sunrisemedical.ca](http://sunrisemedical.ca)

T: +1.800.263.3390  
F: +1.800.561.5834  
E: [mkt.canada@sunmed.com](mailto:mkt.canada@sunmed.com)

Please visit [leckey.com](http://leckey.com) for a full list of Leckey distributors.

---

James Leckey Design Limited  
19 Ballinderry Road  
Lisburn, BT28 2SA  
Northern Ireland

[leckey.com](http://leckey.com)

**(+44) 28 9260 0750**  
[hello@leckey.com](mailto:hello@leckey.com)

