



BeMe

User Manual



Supporting
Children



The Leckey BeMe has been designed to offer postural positioning while enabling function and mobility. This manual shows how you can quickly, easily and safely make use of all the functions. The instructions on safety and maintenance will ensure that you will enjoy the use of this product for a long time.

CONTENTS

1.	Intended Use	p.03
2.	Certification	p.05
3.	Warning and Cautions	p.05
4.	Terms of Warranty	p.07
5.	Product History Record	p.08
6.	Product Training Record	p.08
7.	Safety Information	p.09
8.	Precautions and Contraindications	p.11
9.	Frequent Adjustments for Daily Use	p.12
10.	Cleaning and Care Information	p.31
11.	Daily Product Inspection	p.32
12.	Annual Product Inspection	p.33
13.	Re-issuing Leckey Products	p.34
14.	Product Servicing	p.35
15.	Technical Information	p.36
16.	How to Unpack and Assemble the Seating System	p.42
17.	Fitting the Upholstery	p.83
18.	Clinical Setup for Postural Management	p.99

SECTION 01: INTENDED USE

The Leckey BeMe will interface with a range of mobility bases which are detailed below. The Leckey BeMe is a postural supportive seating system which has been designed for children with disabilities for use at home, in the school environment or outside (if an outdoor base is used).

The Leckey BeMe is available in 3 sizes:

- Small Seat Core is suitable for children with a maximum user weight of 35 kg
- Medium Seat Core is suitable for children with a maximum user weight of 50 kg
- Large Seat Core is suitable for children with a maximum user weight of 70 kg
- Small Backrest is suitable for children with a maximum user weight of 35 kg
- Medium Backrest is suitable for children with a maximum user weight of 50 kg
- Large Backrest is suitable for children with a maximum user weight of 70 kg
- Small High-Low Chassis is suitable for children with a maximum user weight of 35 kg
- Medium High-Low Chassis is suitable for children with a maximum user weight of 50 kg
- Large High-Low Chassis is suitable for children with a maximum user weight of 70 kg



Safety Information -

The maximum user weight of the system should be the **lower** of

- Seat Core
- Backrest
- Chassis

Please see section 8 Precautions and Contraindications for further information.

The seating system is modular and can be used with a choice of indoor or outdoor chassis. The High-Low chassis has been designed for use with the Leckey BeMe and is available in indoor-only and outdoor variants. The outdoor version can be used outdoors on a level surface.

The Leckey BeMe will interface with a range of mobility bases which are detailed below.

Leckey BeMe	Mobility Base Options	Interface Required
Small	Sunrise Medical Zippie Iris	150-1760
	Sunrise Medical Quickie Iris	150-1760
	Sunrise Medical Quickie SR45	150-1760
	Sunrise Medical Q300M (including Mini)	150-1771
Medium	Sunrise Medical Zippie Iris	150-2760
	Sunrise Medical Quickie Iris	150-2760
	Sunrise Medical Quickie SR45	150-2760
	Sunrise Medical Q300M (including Mini)	150-2771
	Sunrise Medical Q400	150-2771
Large	Sunrise Medical Quickie Iris	150-3760
	Sunrise Medical Quickie SR45	150-3760
	Sunrise Medical Q300M (including Mini)	150-3771
	Sunrise Medical Q400	150-3771

Full details can be found on the Leckey website at www.leckey.com

Indications for Use

BeMe is a modular seating system designed to cater for the needs of children with a variety of disabilities which effect their ability to sit independently without external postural supports. It is indicated for use primarily within a home, indoor school environment or outdoors, if used on a mobility base. There are three sizes; with maximum user weight of 35kgs (110lbs), 50kgs (132lbs), and 70kgs (154lbs) respectively.

The configurable postural support offered by the BeMe Seat is indicated for use for children with mild to complex postural needs (GMFCS III-V).

SECTION 02: CERTIFICATION

The Leckey BeMe is classified as a Class 1 Medical Device under EU and UK regulations. As the manufacturer, James Leckey Design Ltd, declares that this product conforms to the Medical Device Regulation (2017/745), UK Medical Device Regulations 2002, and EN 12182:2012 Assistive products for persons with disability, general requirements and test methods.

Notice to the user and/or patient: Any serious incident that has occurred in relation to the device should be reported to the manufacturer and the competent authority of the Member State in which the user and/or patient is established.

SECTION 03: WARNINGS AND CAUTIONS

Note: Not following these instructions may result in physical injury, damage to the product or damage to the environment!

- **Warning Toppling Hazard:** Using the high-low chassis and seat in extremes of its range of positions will reduce its stability. When using high-low chassis, only use the seat at maximum height and/or maximum seat recline when on level ground (less than 2-degree slope). When using the seat on slopes/ramps (up to 10 degrees) ensure that the seat back is in the upright position and the seat height is at its lowest.
- **Warning Finger Trap Hazard:** Take care that the fingers of the operator or children on the floor do not get trapped in the raising and lowering mechanism of the powered high-low chassis.
- **Warning Occupant Security:** Ensure that when 2-point belt is used, webbing is fed through the slot on the seat core above the camlock.
- **Warning Occupant Security:** Ensure that all the occupant harnesses and especially the pelvic belts are fastened and adjusted to hold the occupant securely in place before moving the seat or leaving the vicinity of the static seat.
- **Warning Occupant Security:** Dynamic backrest should be set to “firm” when BeMe is used in transportation.

- **Caution Finger Pinch Hazard:** Take care when assembling or adjusting the position of the seat components that your fingers do not get pinched such as positioning seat components and tightening mountings.
- **Caution Daily Checks:** The seating system is to be checked daily before use to ensure that all harnesses and seating elements are securely attached to the seat and chassis. Also check the battery charging cable for signs of damage before use. See Section 11 for details of checks.
- **Caution Trip Hazard with Powered Chassis:** Ensure that battery charging connection for the powered chassis is removed from the seating system before moving the seat.
- **Caution Cleaning:** Clean the seating system regularly to prevent the build-up of dirt on the seating elements and the chassis. Accumulated dirt can prematurely wear the seat cushions and encourage corrosion on the chassis. Only use non-abrasive household cleaners and moist cloths, do not use running water on the upholstery whilst it is still attached to the seat. See Section 10.
- **Caution Cleaning Power Washers/ Hoses:** Do not use hoses or power washers on the frame components, the electric seat lift system is not sealed against running water and may be damaged by water ingress. See Section 10.
- **Caution Servicing/Repair of Electronic Components on Powered High-Low Chassis:** There are no user-serviceable components in the electric powered high-low chassis power lifting assembly. Servicing and repairs are only to be carried out by Leckey-authorised personnel.
- **Caution Disposal:** Only dispose of the seating system in a community waste disposal site and ensure that the electrical components are removed for separate disposal.
- **Caution Bringing into Use:** When bringing the seating system into use from storage, allow it to acclimatise to ambient temperature for 2 hours first. Wipe off any moisture that has condensed on the product.

SECTION 04: TERMS OF WARRANTY

The warranty applies only when the product is used according to the specified conditions and for the intended purposes, following all manufacturers' recommendations (also see general terms of sales, delivery and payment on our website [<https://www.leckey.com/terms-and-conditions-of-sale>]).

A three-year warranty is provided on all Leckey manufactured products and components.

SECTION 4.1: ADDITIONAL WARRANTY INFORMATION

For goods provided by Sunrise Medical Pty Ltd in Australia, our goods come with a guarantee by Sunrise that cannot be excluded under the Australian Consumer Law. You are entitled to a replacement or refund for a major failure and for compensation for any other reasonably foreseeable loss or damage. You are also entitled to have the goods repaired or replaced if the goods fail to be of acceptable quality and the failure does not amount to a major failure. The benefits to you given by this warranty are in addition to your other rights and remedies under a law in relation to the goods to which the warranty relates.

SECTION 5: PRODUCT HISTORY RECORD

Your Leckey product is a Medical device and should only be prescribed, set up or reissued for use by a technically competent person who has been trained in the use of this product. Leckey recommend that a written record is maintained to provide details of all setups, reissue inspections and annual inspections of this product.

SECTION 6: PRODUCT TRAINING RECORD

[Parents, Teachers & Carers]

Your Leckey product is a prescribed Class 1 Medical Device and Leckey recommend that parents, teachers and carers using the equipment should be made aware of the following sections of this user manual by a technically competent person:

- **SECTION 7** Safety Information
- **SECTION 9** Frequent Adjustments for Daily Use
- **SECTION 10** Cleaning and Care
- **SECTION 11** Daily Product Inspection

Leckey recommend that a written record is maintained of all those who have been trained in the correct use of this product.

SECTION 7: SAFETY INFORMATION

- 7.1** Always read instructions fully before use.
- 7.2** To improve safety we recommend that users should not be left unattended at any time whilst using Leckey equipment.
- 7.3** Only use Leckey approved components with your product. Never modify the product in any way. Failure to follow instructions may put the user or carer at risk and will invalidate the warranty on the product.
- 7.4** If in any doubt to the continued safe use of your Leckey product or if any parts should fail, please cease using the product and contact our Customer Care Team or your local dealer as soon as possible.
- 7.5** Carry out all positional adjustments and ensure that they are securely fastened before you put the user into the product. Some adjustments may require the use of a tool which is provided with each product. Keep all tools out of reach of children.
- 7.6** When putting the user into a seating system, both for positional and safety reasons, always secure the pelvic belt first.
- 7.7** When the product is stationary ensure that all castors are locked and facing away from the base, as this will improve product stability. This is especially important when the tilt-in-space or back recline facility is in use.
- 7.8** When the seat is in use on a High-Low chassis please ensure that the height adjustment pedal and tilt-in-space lever are locked off and cannot be adjusted accidentally by other children.
- 7.9** When the Leckey seating systems are used on the High-Low chassis we do not recommend that users are moved over uneven surfaces when in the equipment. All due care and attention should be taken if transferring in and out of the seat.
- 7.10** Only use the push handle to steer and move the seat from one area to another. Never use the tray or headrest for this purpose.
- 7.11** The product contains components which could present a choking hazard to small children. Always check that locking knobs and bolts within the child's reach are always tightened and secure.
- 7.12** Leckey products comply with fire safety regulations in accordance with EN12182. However, the product contains plastic components and therefore should be kept away from all direct sources of heat including naked flames, cigarettes and gas heaters.
- 7.13** Do not place objects hotter than 40o C [104 o fahrenheit] on the tray.
- 7.14** The product is designed for indoor use and when not in use should be stored in a dry place that is not subjected to extremes of temperature. The safe operating temperature range of the product is +5 to +40 degree Celsius [41 to 104 o fahrenheit].
- 7.15** Always check the plastic hand knobs on the push handle are tightened securely before you move the seat unit and that push handle is secured to the chassis by means of two button head screws.
- 7.16** Before using the seating system always check that the seat core is fully engaged with the chassis. If the seat core is not engaged properly the seat unit may come loose and could cause serious injury to the child or carer.

7.17 Please be aware of the gap on the underside of the tray where a child could insert their finger between the metal bracket and the base of the plastic tray.

7.18 The maximum user weight of the system should be the **lower** of the seat, backrest and chassis.

7.19 Always ensure when using the tilt in space mechanism, that you hold the handlebars or secure the seat so that it does not jerk upon activation.

Leckey BeMe – Crash Test

The Leckey BeMe has been crash tested and passed for use in vehicles and meets the requirements of ISO16840 part 4. For further details please contact our Customer Care Team. It has been tested in its complete configuration on a surrogate base with a Leckey head support attached.

If the Leckey BeMe seat is being used in a vehicle the following points must be adhered to:

- The Leckey BeMe must be positioned forward facing.
- It must be used with an Unwin Restraint System and a head support which should be suitably positioned at all times during transportation.

Important

These crash test details refer to the Leckey BeMe and interface plate only. If you are using the Leckey BeMe on a mobility base, please refer to the wheelchair manufacturer's handbook for crash test details.

MEDICAL DEVICE COMBINATIONS

It may be possible to combine the Leckey BeMe with one or more other Medical Device or other products. Information on which combinations are possible can be found at www.leckey.com. All combinations listed have been validated to meet the General Safety and Performance Requirements, section 14.1 of the Medical Device Regulation 2017/745.

Guidance on the combination, such as mounting, can be found at www.leckey.com

SECTION 8: PRECAUTIONS AND CONTRAINDICATIONS

Precautions

- Fixed spinal deformities such as scoliosis or kyphosis
- Severe muscle contractures
- Severe muscular or skeletal asymmetry including hip dislocation
- Progressive and muscle wasting conditions
- High risk or recent history of bone fractures
- High risk of pressure related injury or open sores
- Strong, uncontrolled movement patterns
- Poorly controlled seizure activity
- Children dependent on the use of percutaneous endoscopic gastrostomy
- Medical instability including compromised respiratory or cardiovascular function
- Dependant on 3rd party life-sustaining apparatus such as oxygen tanks
- Significant learning disabilities and/or behavioural issues

Contraindications

There are no contraindications associated with the Leckey BeMe product.

All precautions and contraindications are taken at the discretion of the prescribing clinician. Leckey recommends a trained and experienced clinician to be present during the initial assessment, set up, configurations and re-issues to minimise risk.

SECTION 9: FREQUENT ADJUSTMENTS FOR DAILY USE

[Therapists/Carers/Parents]

Parents and carers should be shown how to make frequent adjustments and be made aware of the safety checks in Section 7 by a technically and clinically competent person who has been trained in the use of the product. Leckey recommend that a written record is maintained of all parents and carers who have been trained in the use of this product.

SECTION 9.1: TRANSFERRING CHILD IN AND OUT OF SEAT

Before transferring the child into the seat, carry out the daily product inspection as outlined in section 11 of this user manual.

Adjust the seat to a comfortable angle to facilitate transfer. Lock all the castors, ensuring that they are facing outwards to maximise product stability.

If the seat has flip-away chest laterals, chest harness or flexible wrap-around laterals, first move these out of the way [see section 9.2]

Unclip the pelvic belt or pelvic cradle in the middle, undo the side Velcro of the pelvic cradle and allow the harness to open out to facilitate transfer. Lastly, if sandals are fitted, open the straps. You are now ready to transfer or hoist the child into the seat.

The pelvic belt and pelvic cradle are fastened using the middle buckle, and side Velcro (in the case of the pelvic cradle). Always ensure that the clip is closed securely when the user is in the seat.

SECTION 9.2: OPERATING FLIP AWAY LATERALS

To operate the flip away laterals, pull the pin **B** shown in the picture below.



To aid transfers, the flexible wraparound hugging lateral cover can be temporarily flexed outwards and secured under the elastic straps.

SECTION 9.3: ATTACHING, DETACHING AND ADJUSTING 4-POINT BELT

To attach the 4-point belt, pass the grey webbing **through the upper slot** in the seat moulding **A**, and then through the cam buckle **B**. Pass the black webbing through the cam buckle at the front **C**. Pull the webbing taut and secure the cam buckles. Ensure belt is orientated with padding facing towards child.

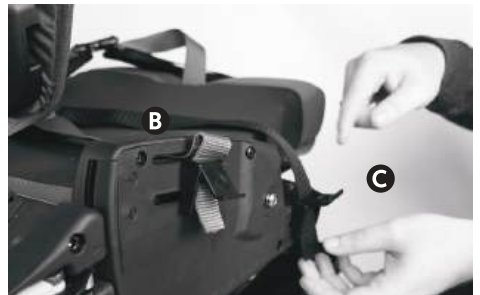
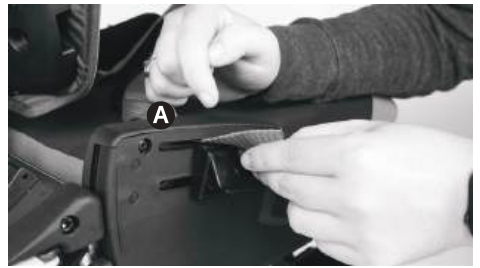

Attach the buckle **D**, at the front to secure the user.

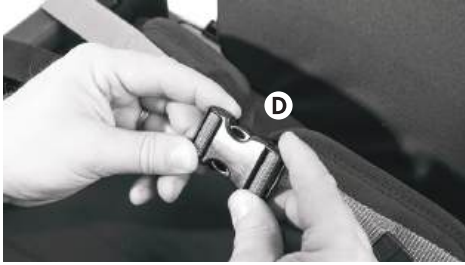

 Always attached the pelvic strap first before making any other adjustments.



To detach the 4-point belt, reverse the process.

 **Safety Information:** You must ensure when using the 2-point belt that the webbing is fed through the slot in the seat core (not over the seat core). This is also recommended when using the 4-point belt.

SECTION 9.4: ATTACHING, DETACHING AND ADJUSTING 2-POINT BELT

To attach the 2-point belt, pass the grey webbing through the upper slot in the seat moulding **A**, and then through the cam buckle **B**. Pull the webbing taught and secure the cam buckles. Ensure belt is orientated with padding facing towards child.

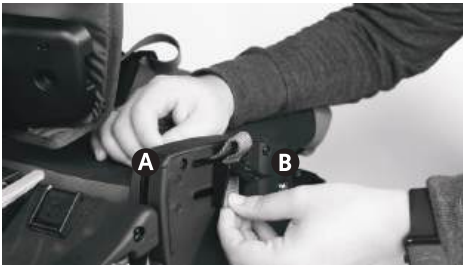

Attach the buckle **C**, at the front to secure the user.



To detach the 2-point belt, reverse the process.



Safety Information: You must ensure when using the 2-point belt that the webbing is fed through the slot in the seat core (not over the seat core). This is also recommended when using the 4-point belt.



Always attached the pelvic strap first before making any other adjustments.

SECTION 9.5: ADJUSTING PELVIC CRADLE

The pelvic cradle can be tightened or loosened for user comfort and pelvic stability using the grey webbing at the front **1**, or the flip down locks at the side **2**.



SECTION 9.6: CHASSIS HEIGHT ADJUSTMENT – GAS SPRING

For safety, the height adjustment pedal on the chassis should be locked by engaging the pull pin **C**, on the right-hand side of the pedal. To unlock, pull the pin out and rotate 90 degrees. The pedal can then be operated.

You can carry out this adjustment with the child in the chair. To adjust the height of the high-Low chassis, press the foot lever **A**, at the rear of the chassis whilst holding the push handle **B**. Once you remove your foot from the pedal the seat will be fixed at the chosen height.

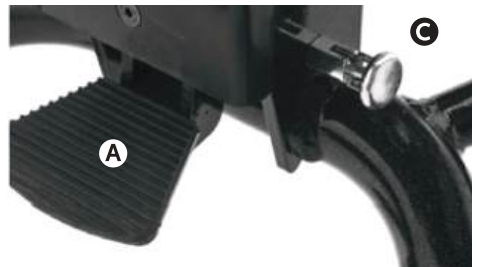

You should reengage the safety pin after using the high-low function.

SECTION 9.7: CHASSIS HEIGHT ADJUSTMENT – HYDRAULIC (PUMP ACTION)

To raise the chair pump the foot pedal several times until the desired height is reached (the chair will raise with each pump). To lower the chair place your foot under the pedal and gently lift the pedal up (the chair will automatically lower).



SECTION 9.8: CHASSIS HEIGHT ADJUSTMENT – ELECTRIC

The powered chassis can be easily adjusted with the push button control handset and can be height adjusted with the client in the chair. The chassis can be powered up and down, and usually takes 17 seconds to travel the full range (260mm).



When not in use, ensure the push button control handset is stowed on the chassis as shown **A**:



Before the product is used for the first time it is recommended that the battery should be fully charged for 12 hours. To do this, plug the supplied charger into the side of the battery pack **A**, and plug into a wall AC supply. The charger will show a light to indicate its status

- Green: Plugged into mains;
- Yellow: Charging;
- Back to Green: when the battery is fully charged.

When charged, switch off the wall AC supply, remove the adaptor plug and disconnect the lead from the battery. Ensure to disconnect the battery charger from the battery before moving the seat. The battery charge should be topped up each day for approximately one hour. The electrical seat height adjustment can be operated whilst the battery is on charge.



Before operation, ensure that the cable to the hand controller is not caught or wrapped around any of the chassis parts.

When operating, ensure that neither you nor any child at floor level has got their fingers in the way of the seat lifting arm.

Ensure the battery charger is disconnected from the battery before moving the seat.

Battery duty cycle: 2 minutes of operation in 20 minutes [i.e., leave the battery to cool down for 18 minutes if operated for 2 minutes continuously].

The electrical items are rated IP51 and are not waterproof. Only clean with a damp cloth and do not clean with running water as water may enter the cable connections.

If taking the product out of a cold storeroom, allow 2 hours for it to come to room temperature and wipe it down to remove any condensed moisture before operation.

SECTION 9.9: TILT IN SPACE – SMALL HIGH-LOW CHASSIS



Warning:

You must ensure you are holding the push handle with one hand while operating the tilt- in-space, to prevent the user from jerking forward.

Always keep the tilt-in-space lever in the locked position to prevent accidental actuation of the lever which could cause the seat unit to jolt and possibly cause injury to the child.

Please use the handle bars when operating tilt-in-space.

Always check with your therapist that the use of tilt-in-space will not cause any obstructions to the child's airways.



Warning: Only use the tilt-in-space feature on level ground. If the tilt-in-space is used with high seat positions, then there is a risk of the seating system becoming unstable when parked on a sloping surface. The tilt-in-space can be angled while the user is in the seat. Before you adjust the tilt-in-space angle of the seat, always ensure the pelvic belt is secured preventing the user from sliding forward in the seat.

To unlock the tilt, pull out and twist the locking pin **1**. Press the lever to operate the tilt **2**. Always make sure you are holding the seat or push handle to prevent sudden movement.

1



2



SECTION 9.10: TILT-IN-SPACE – MEDIUM HIGH-LOW CHASSIS

 **Warning:**

You must ensure you are holding the push handle with one hand while operating the tilt-in-space, to prevent the user from jerking forward.

 **Warning:** Only use the tilt-in-space feature on level ground. If the tilt-in-space is used with high seat positions, then there is a risk of the seating system becoming unstable when parked on a sloping surface. The tilt-in-space can be angled while the user is in the seat. Before you adjust the tilt-in-space angle of the seat, always ensure the pelvic belt is secured preventing the user from sliding forward in the seat.

To adjust the tilt angle, press the lever under the seat base. Once you have selected the angle you require, simply remove your hand from the lever and the chair will be locked in position. The tilt-in-space should be locked off while the user is in the seat.

To lock the lever, twist the pull pin to the right-hand side of the lever and the pin will pop into position **2**. You may have to lift the lever slightly to allow it to lock. To unlock pull the pin out and rotate 90 degrees, the lever can then be operated **1**.



Always keep the tilt-in-space lever in the locked position to prevent accidental actuation of the lever which could cause the seat unit to jolt and possibly cause injury to the child.

Please use the handle bars when operating tilt-in-space.

Always check with your therapist that the use of tilt-in-space will not cause any obstructions to the child's airways.

SECTION 9.11: TILT IN SPACE – LARGE HIGH-LOW CHASSIS



Warning: Only use the tilt-in-space feature on level ground. If the tilt-in-space is used with high seat positions, then there is a risk of the seating system becoming unstable when parked on a sloping surface. The tilt-in-space can be angled while the user is in the seat. Before you adjust the tilt-in-space angle of the seat, always ensure the pelvic belt is secured preventing the user from sliding forward in the seat.

To adjust the tilt angle, pull the lever on the push handles **1**, tilt the seat to the required angle and remove your hand from the lever.



Always keep the tilt-in-space lever in the locked position to prevent accidental actuation of the lever which could cause the seat unit to jolt and possibly cause injury to the child.

Please use the handle bars when operating tilt-in-space.

Always check with your therapist that the use of tilt-in-space will not cause any obstructions to the child's airways.

SECTION 9.12: ADJUSTING DYNAMIC BACKREST RESISTANCE

The resistance to increasing back angle is adjusted by varying the air pressure and should be determined by the user's weight, seating position, seat design and personal preference.

The air pressure is adjusted with an air pump **A** (supplied with every dynamic back), on the main air valve of the dynamic mechanism **B**.



To increase the air pressure, pump air into the valve, to the desired pressure. To decrease the pressure, press the air release valve on the pump until the desired pressure is reached.



Warning: The pressure range is 50-250psi. Never exceed an air pressure of 250psi in the uncompressed shock system. Exceeding the maximum air pressure of 250lbs/inch could result in serious injury.

SECTION 9.13: ADJUSTING DYNAMIC BACKREST SPEED

To adjust the dynamic backrest speed of return, rotate the red wheel **A**, on the dynamic shock. Rotating the wheel clockwise will decrease the speed of return and rotating it anti-clockwise will increase the speed of return.

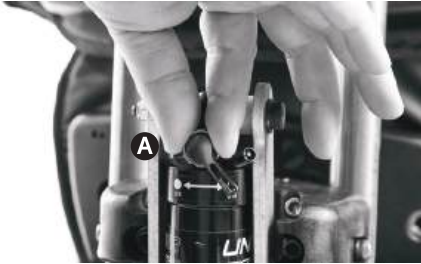

The amount of return strength needed depends on the user's weight, the spring rate, which is set by the air pressure, the amount of use, the sitting style and personal preferences. The best way to adjust the return strength is to decrease it completely and test by placing the user in the seat. Slowly increase the strength until the user feels comfortable and safe without the suspension moving the user too far forward.

SECTION 9.14: SETTING DYNAMIC BACKREST TO “FIRM”

To lock the dynamic backrest, toggle the blue lever on the dynamic shock to the 'lock' position **A**. To unlock the dynamic backrest, toggle to the 'open' position **B**.

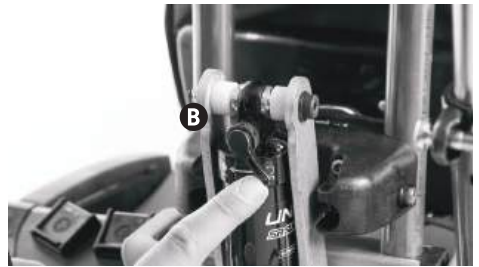

Safety Information: Blue Lever should be set to “Firm” when BeMe is used in transport.

SECTION 9.15: BUTTERFLY HARNESS ADJUSTMENT

To adjust the butterfly harness, either change the amount of webbing passing through the cam buckles at the back of the seat base **A**, or top of the backrest **B**. Or, adjust the length of the webbing on the harness straps, in any of the four corners of the harness **C**.

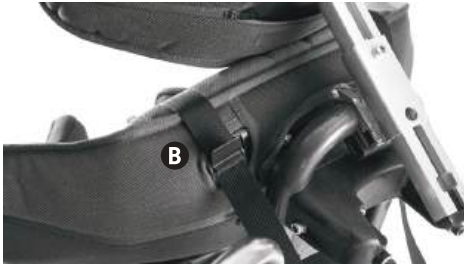
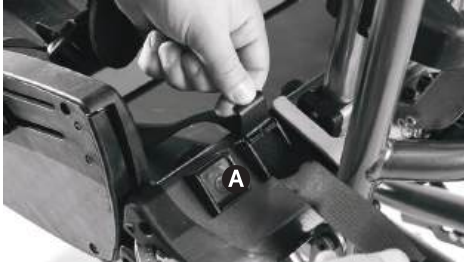

SECTION 9.16: ATTACHING AND DETACHING TRAY

Before inserting the tray, ensure that the cam lever **A**, located at the front of each armrest is open.

To attach the tray, insert the tray tubes through the centre of the armrest **B**, ensuring that the tray tube protrude out the other side of the receiver **C**. Once the tray is located in the desired position the cam lever **A**, should be tightened securely.



Always use caution to ensure the child's hands or arms do not become trapped when inserting the tray.

Never use the tray to steer or push the chair.

Do not place objects, hotter than 40 degrees Celsius (104 degrees Fahrenheit) on the tray.

Please note that the tray is for the use of the user only. Do not lean or place objects on the tray, greater than 8kgs (17.6lbs).



Please be aware of the gap on the underside of the Tray where a child could insert their finger between the metal bracket and the base of the plastic tray.

To detach the tray, reverse the process.

SECTION 9.17: ADJUSTING TRAY ANGLE

To adjust the tray angle, locate the cam lever, **A**, in the centre of the armrest. Raise the cam lever to unlock and change the angle of the tray/armrest **B**, to the desired position. Secure by lowering the cam lever to the locked position **C**.

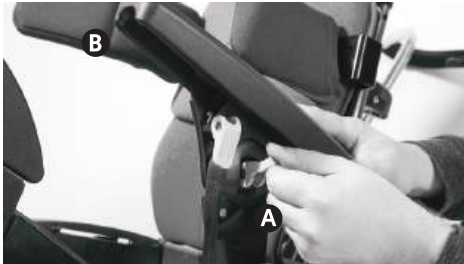

SECTION 9.18: ADJUSTING ARMREST ANGLE

To adjust the armrest angle, locate the cam lever **A**, in the centre of the armrest. Raise the cam lever to unlock and change the angle of the armrest **B**, to the desired position. Secure by lowering the cam lever to the locked position **C**.



Always use caution to ensure the child's hands or arms do not become trapped when inserting the tray.

Never use the tray to steer or push the chair.

Do not place objects, hotter than 40 degrees Celsius (104 degrees Fahrenheit) on the tray.

Please note that the tray is for the use of the user only. Do not lean or place objects on the tray, greater than 8kgs (17.6lbs).

SECTION 9.19: OPERATING FLIP AWAY FOOTPLATE

To flip up the one-piece footplate, locate the plunger **A**, on the underside of the footplate and pull the plunger outwards to release the pin. Rotate the footplate upwards **B**, and release the plunger, the pin will locate in an upward locking position.

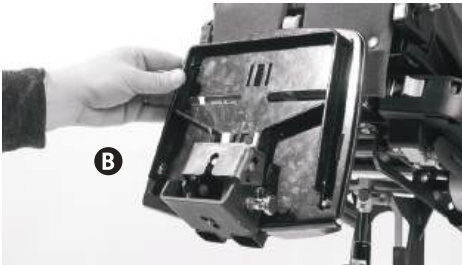

To drop down the one-piece footplate, reverse the process.

The individual footplates do not have a locking mechanism. To flip the individual footplates up, simply rotate each footplate into an upward position.

SECTION 9.20: ADJUSTING SANDALS

To position the user's feet in the sandals, secure the Velcro straps provided so the foot is held in place. The straps should be placed over the bridge of the foot **A**, and over the toes **B**. The front strap can be fed through one of two slots on either side of the sandals, depending on the size of the user's feet.

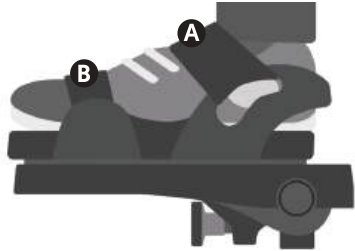

If the child is wearing sandals or light footwear check the straps to make sure the webbing does not irritate the skin.

To adjust the sandal position on the footplate, loosen the knob **C**, and move to the desired position **D**. Tighten the knob to secure in place.

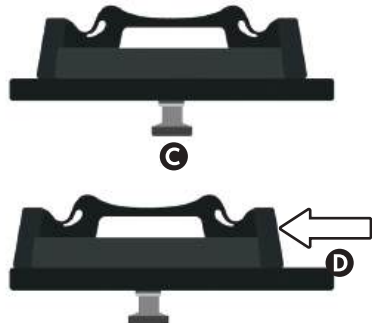

SECTION 9.21: ADJUSTING ANKLE WRAPS

To adjust the ankle wrap, adjust the position of the Velcro straps around the bridge of the foot **A**, and around the ankle **B**.



SECTION 9.22: ADJUSTING ANKLE HUGGERS

To adjust the ankle hugger, adjust the position of the Velcro strap around the ankle **A**, and the length of the strap through the triglide **B**.



SECTION 9.23: APPLYING THE BRAKES

To apply the brakes on an indoor chassis, apply pressure with your foot to the brake pedal **A**, until a click is heard. Repeat for all four castors. To release the brakes, tap the top of the brake pedal with your foot so that the pedal flips back to its original, standard position.



To apply the brakes on an indoor/outdoor chassis or large high-low chassis, push down on the push-pull manual brake lever **B**, located at the front of the back wheel. To release, pull up on the lever. There are no front wheel brakes on an indoor/outdoor chassis or large high-low chassis.



To apply the brakes on a mobility base refer to the manufacturer's instructions.

SECTION 9.24: ADJUSTING HEIGHT OF PUSH HANDLE

To adjust the height of the push handle, rotate to loosen both the locking levers **A**, on the push handle tubes and raise or lower to the desired position. Rotate the locking levers to tighten into position.



SECTION 9.25: ATTACHING AND DETACHING POMMEL

The pommel attaches to the basic seat only.
The correct orientation of the pommel is the thinner edge facing towards the child.

To attach the pommel, open the cam lock at the front of the seat **A**, and place the pommel bracket through the opening in the seat cushion and into the receiver slot on the seat **B**. To secure in place, push down firmly on the lever **C**. Orientate the pommel so that it sits external to the seating area.

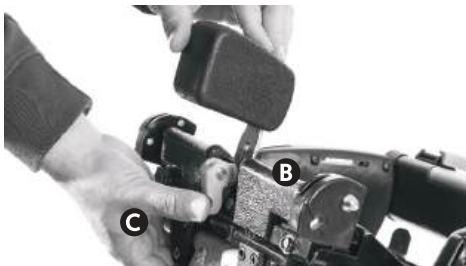

If the attachment mechanism becomes loose over time, it can be tightened by tightening the screw (clockwise) located within the cam lever when in the raised position **A**. To detach the pommel, reverse the process.

SECTION 9.26: ATTACHING AND DETACHING FEMORAL GUIDES

To attach the femoral guide, slot the femoral guide stem **A**, into the receiver on the seat **B** and press downwards. Check that the femoral guide has self-locked by pulling upwards on the femoral guide.

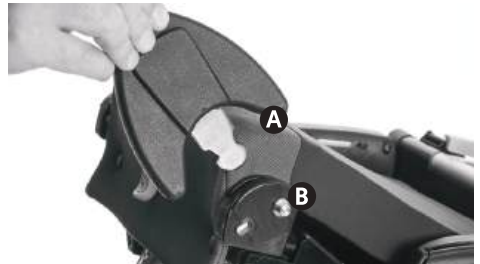

To detach the femoral guide, slide the silver release button diagonally upwards **C**, and pull the femoral guide out of the slot.

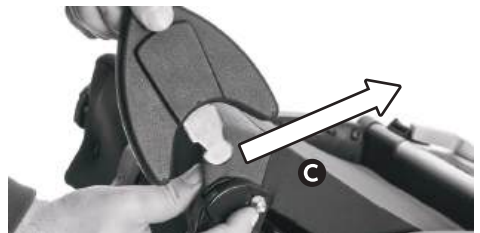

SECTION 9.27: ATTACHING AND DETACHING BACKREST

To attach the backrest, locate the backrest receiver at the back of the seat base **A**. Open up the receiver lock paddles **B**, at the back of the seat base by pulling **horizontally outwards** on the paddles and then rotating upwards.



Place the base of the backrest **C**, into the receiver, ensuring it is as deep into the receiver as it can go. Rotate the paddles downwards **D**, and push inwards **E**, to secure the backrest in place.

Check that it is secure by pulling up on the backrest and moving it forward and back.

SECTION 10: CLEANING AND CARE INFORMATION

How to maintain:

When cleaning we recommend that you use only warm water and a non-abrasive detergent. Never use organic solvents or dry-cleaning fluids.

Upholstery and fabrics

The cushion covers can be removed, machine washed at 60°C (low spin is recommended where possible) and tumble dried at a low temperature. Please note the stretch fabric may show discolouration after multiple washes at 60°C, but this will not affect the performance of the fabric. To prevent this, a lower temperature can be used.

Please remove the foam from the following covers before washing:

- Basic Backrest
- Seat Cushions

All other soft upholstery can be placed into the washing machine intact, after removing any fastenings.

1. The upholstery and fabrics can also be cleaned by hand whilst in place. When cleaning we recommend that you use only warm water and a non-abrasive detergent.
2. Innovative feature – our stretch fabric will be impermeable to liquid for 30 minutes after spillage to allow time for cleaning.

3. Staining should be removed as quickly as possible with absorbent cloth, towels or a sponge. Routine soap and warm water sponging are effective for ordinary soiling and minor spills. Be careful not to over wet the fabric as this will cause the staining to spread.
4. Antiseptic cleaning agents can be used on more stubborn stains. These may require a safe solvent such as Isopropyl Alcohol or Mineral Spirit.
5. The pelvic and trunk harnesses can be machine washed at 60°C. Make sure all bolts and fasteners are removed first as they may cause damage to your washing machine. Store these in a safe place and out of reach from children.
6. Always ensure the product is dry before use.

Metal and plastic components

1. Soap and water or antibacterial spray can be used for daily cleaning.
2. The chassis should be cleaned with a damp cloth- do not use running water.
3. Do not use solvents to clean plastic or metal components.
4. Make sure the product is dry before use.

SECTION 11: DAILY PRODUCT INSPECTION

[Therapists, Parents & Carers]

We recommend that daily visual checks of the equipment are carried out by therapists, carers or parents to ensure the product is safe for use. The recommended daily checks are detailed below.

1. Check that there is no lateral movement or wobble in any of the moving parts. Ensure all adjustment knobs and bolts are in place and secure.
2. Check all upholstery and Velcro for signs of wear and tear.
3. Check all castors are moving freely and lock securely.
4. Ensure seat unit is securely fixed onto the chassis. Also ensure the reclining back locking levers are fully engaged.
5. Ensure the pelvic belt is fully secured around the user and they cannot slide or creep forward in the seat.
6. Ensure the footplate is attached securely.

If in any doubt to the continued safe use of your Leckey product or if any parts should fail, please cease using the product and contact our Customer Care Team or your local dealer as soon as possible.

SECTION 12: ANNUAL PRODUCT INSPECTION

[Therapist, Technician, Leckey Product Specialist, Dealer]

Leckey recommend that each product should be subject to a detailed inspection at least once a year and every time the product is reissued for use. This inspection should be carried out by a technically competent person who has been trained in the use of the product and should include the following checks as a minimum requirement.

1. Check that there is no lateral movement or wobble in any of the moving parts. Ensure all adjustment knobs and bolts are in place and secure.
2. Check all ratchet handles, knobs, nuts, bolts and plastic buckles are in place, replacing any missing items. Paying particular attention to the following items;
 - Head support locking bolts.
 - Backrest height and angle adjustments bolts.
 - Seat depth adjustment bolts.
 - Pelvic belt / hip guide attachments.
 - Footrest height and angle adjustment.
3. Check the high-low chassis height adjustment mechanism is working properly. If the chassis is foot pedal operated ensure the seat height doesn't change when the pedal is released. Also, check that the locking pin engages securely to prevent accidental height adjustment of the chassis.
4. Adjust the seat to its maximum range of tilt-in-space and ensure that the locking lever locks the seat out securely at varying point in this range.
5. Check that where the seat and chassis join there is no visible wear and tear on the metal components.
6. Lift the base to check each castor individually. Make sure they are moving freely and remove any dirt from the rubber wheels. Check that the brakes lock the wheels securely.
7. Visually check the structure of the product paying attention to weld points on the frame ensuring there are no signs of fatigue or cracking around the welds.
8. Leckey recommend that a written record is maintained of all annual product inspections.

If in any doubt to the continued safe use of your Leckey product or if any parts should fail, please cease using the product and contact our Customer Care Team or your local dealer as soon as possible.

SECTION 13: RE-ISSUING LECKEY PRODUCTS

[Therapists, Parents & Carers]

Most Leckey products are assessed and ordered to meet the needs of an individual user. Before reissuing a product, we recommend that the therapist prescribing the product has carried out an equipment compatibility check for the new user and has ensured that the product being re-issued contains no modifications or special attachments.

A detailed technical inspection should be carried out on the product prior to re-issuing. This should be carried out by a technically competent person who has been trained in the use and inspection of the product. Please refer to section 12 for the required checks to be carried out.

Ensure the product has been cleaned thoroughly in accordance with section 10 of this manual.

Note: Always clean the product first to remove accumulated soiling prior to disinfecting/sanitising

1. Where possible, we recommend the use of an automated “fogger” disinfection system that is used to completely cover the product surfaces with a disinfectant agent. The manufacturer’s instructions for the chosen system should be referred to prior to use and followed exactly.
2. Where an automated disinfection system is not available, all product surfaces should be wiped over with disinfectant

surface wipes or liquid disinfectant on a soft cloth. Suitable products are 70% IPA, 70% Alcohol or diluted bleach. The manufacturer’s instructions for the chosen product should be followed. Product upholstery and fabrics should be cleaned thoroughly in accordance with section, Cleaning and Care Information, of this manual.

Ensure a copy of the user manual is supplied with the product. A copy can be requested obtained from our website leckey.com.

Leckey recommend that a written record is maintained of all product inspections carried out during the reissue of the product.

If in any doubt to the continued safe use of your Leckey product or if any parts should fail, please cease using the product and contact our Customer Care Team or your local dealer as soon as possible.

SECTION 14: PRODUCT SERVICING

Servicing of all Leckey products should only be carried out by technically competent persons who have been trained in the use of the product.

All international service enquiries should be directed to the appropriate Leckey distributor who will be delighted to assist you.

For further information on Leckey distributors please visit our website **www.leckey.com**

SECTION 15: TECHNICAL INFORMATION - METRIC

Seat Core and Seats					
	Small	Medium	Large	Medium Long	Large Long
Seat Depth (mm)	170*-325	275-390	350-475	325-440	400-525
Seat Width Maximum (No Hip Guides) (mm)	275	325	415	325	415
Seat Width Maximum (Contoured)(mm)	250	300	400	300	400
Femoral Width on Split Seat (mm)		90-125	110-160	90-125	110-160
Maximum Weight Limit (kg) **	35	50	70	50	70

Backrest				
	Small	Medium	Large	
Back Height (mm)	360-470	390-520	500-650	
Back Height with Contoured Seat (mm)	370-480	410-500	510-640	
Lateral Width (mm)	130-230	200-300	225-350	
Hip Guide Width (mm)	165-230	200-260	250-350	
Backrest Angle (degrees)	+10 to -25	+10 to -25	+10 to -25	
Maximum Weight Limit (kg) **	35	50	70	

Footrest			
	Small	Medium	Large
Lower Leg length with Basic/Split Seat (mm)	185-285	280-450	290-510
Lower Leg length with Contoured Seat (mm)	185-285	290-460	300-520
Maximum Dorsiflexion (degrees)	+/- 10	+/- 10	+/- 10
Maximum Plantarflexion (degrees)	+/- 10	+/- 10	+/- 10

Chassis						
	Small	Medium Ind Gas	Medium Ind Hydraulic	Medium Ind/Out	Large Hydraulic	Large Power
Footprint Width (mm)	535	690	690	740	800	800
Footprint Length (mm)	635	840	840	880	770/850***	770
Tilt Range (degrees)	-10 to 30	-10 to 25	-10 to 25	-10 to 25	-10 to 30	-10 to 30
Floor to Seat - Minimum	270	340	325	380	460	460
Floor to Seat - Maximum	650	655	615	670	640	640
Maximum Weight Limit (kg) **	35	50	50	50	70	70

*170mm-220mm seat depth requires spacer options

**System max user weight should be lesser of seat, chassis and backrest

*** Including Foot Pedal

TECHNICAL INFORMATION - IMPERIAL

Seat Core and Seats					
	Small	Medium	Large	Medium Long	Large Long
Seat Depth (inches)	6.7-12.8	10.8-15.4	13.8-18.7	12.8-17.3	15.7-20.7
Seat Width Maximum (No Hip Guides) (inches)	10.8	12.8	16.3	12.8	16.3
Seat Width Maximum (Contoured)(inches)	9.8	11.8	15.7	11.8	15.7
Femoral Width on Split Seat (inches)		3.57-4.9	4.3-6.3	3.5-4.9	4.3-6.3
Maximum Weight Limit (lbs) **	77.175	110.25	154.35	110.25	154.35

Backrest			
	Small	Medium	Large
Back Height (inches)	14.2-18.5	15.4-20.5	19.7-25.6
Back Height with Contoured Seat (inches)	14.6-18.9	16.1-19.7	20.1-25.2
Lateral Width (inches)	5.1-9.1	7.9-11.8	8.9-13.8
Hip Guide Width (inches)	6.5-9.1	7.9-10.2	9.8-13.8
Backrest Angle (degrees)	+10 to -25	+10 to -25	+10 to -25
Maximum Weight Limit (lbs) **	77.175	110.25	154.35

Footrest			
	Small	Medium	Large
Lower Leg length with Basic/Split Seat (inches)	7.3-11.2	11-17.7	11.4-20.1
Lower Leg length with Contoured Seat (inches)	7.3-11.2	11.4-18.1	11.8-20.5
Maximum Dorsiflexion (degrees)	+/- 10	+/- 10	+/- 10
Maximum Plantarflexion (degrees)	+/- 10	+/- 10	+/- 10

Chassis						
	Small	Medium Ind Gas	Medium Ind Hydraulic	Medium Ind/Out	Large Hydraulic	Large Power
Footprint Width (inches)	21.1	27.2	27.2	29.1	31.5	31.5
Footprint Length (inches)	25	33.1	33.1	34.6	27.6/33.5***	30.3
Tilt Range (degrees)	-10 to 30	-10 to 25	-10 to 25	-10 to 25	-10 to 30	-10 to 30
Floor to Seat - Minimum	10.6	13.3	12.8	15	18.1	18.1
Floor to Seat - Maximum	25.6	25.8	24.2	26.3	25.2	25.2
Maximum Weight Limit (lbs) **	77.2	110.3	110.3	110.3	154.4	154.4

*6.7inches-8.7inches seat depth requires spacer options

















**System max user weight should be lesser of seat, chassis and backrest

*** Including Foot Pedal

TECHNICAL SPECIFICATIONS:

Feature	Parameter	Value
Make and Model	Actuator	LINAK 281209-01
	Battery	LINAK BA18021-00
	Hand Controller	LINAK HB41000-00004
	Battery Charger	LINAK Battery Charger CH01. Only use this supplied battery charger
Seat lift operation	Duty Cycle	Maximum 10% Or 2 min continuous followed by 18 min not in use
	Actuator Force	3500N push, 2000N pull
	Actuator operating speed	4.7mm/sec at full load
	Noise level	48 dB[A]
Environmental	IP Rating	IP51 (not waterproof, clean with a damp cloth only)
	Operation	+5 deg C to 40 deg C 20% to 80% RH, non-condensing
	Transport and Storage	-10 deg C to 50 deg C 20% to 80% RH, non-condensing
		Allow 2 hours for the device to come to room temperature after removing from storage
	Height above sea level	Max 3000m
Electrical	Actuator operating voltage	24V
	Actuator operating current	Maximum 3.9A
	Charger input	100 – 240 Vac, 50/60 Hz
	Charger output	27.6 Vdc ± 2%
	Charging current	Max 500 mA
	Charging indication on charger	Green LED – Mains power Yellow LED – Charging, turns to Green when battery fully charged
Certification	EMC	IEC60601-1-2:2014 for home use environment
	Electrical Safety	IEC60601-1:2005/A1:2012

TABLE OF SYMBOLS

Symbol	Meaning
	Medical Device
	Read The Instructions For Use
	Ce Mark
	Warning
	Manufacturer
	Serial Number
	Product Code
	Max Occupancy Weight
	Date Of Manufacture
	Latex Free
	Unique Device Identification
	Crash Tested
	Machine Wash - Water Temperature 40°C
	Tumble Dry - Low Heat
	Do Not Iron
	Do Not Bleach

SECTION 16: HOW TO UNPACK AND ASSEMBLE THE SEATING SYSTEM

Check Parts

Upon purchasing your Leckey BeMe Seating System, all the parts will be contained in polythene bags with each one clearly labelled. Carefully remove them from the boxes and check all the parts you have ordered.

Some of the accessories will need to be assembled before you attach the seat to the base you have purchased. If you are fitting the seat to a mobility base, please ensure you fit the interface plate to the mobility base first. Instructions on how to attach the interface to specific bases will be provided with the interface plate. Once you have checked all the components you are then ready to assemble the BeMe Seating System and attach it to its base.

Tools

Several adjustments will require the use of the multi-tool or long handled Allen key, which is supplied with each seat.



Safety First: Keep polthene bags away from children.

SECTION 16.1: ATTACHING AND DETACHING SEATING UNIT TO CHASSIS

Adjust the height of the chassis to its maximum to reduce risk of back strain while attaching the seat base. Refer to Section 9 on how to adjust the height of the chassis you have purchased.

Before attaching the seat base, ensure the locking latch at the front is released **A**. If the locking latch is locked **B**, then the following steps should be completed.

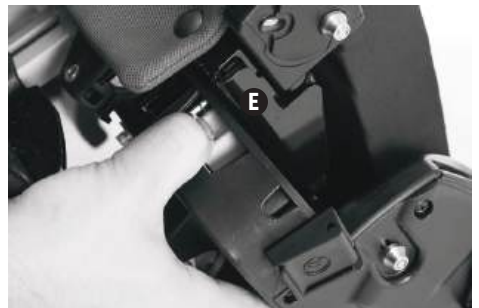
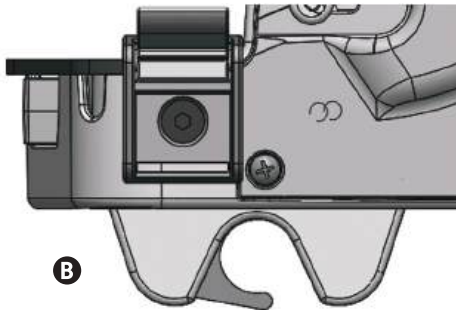
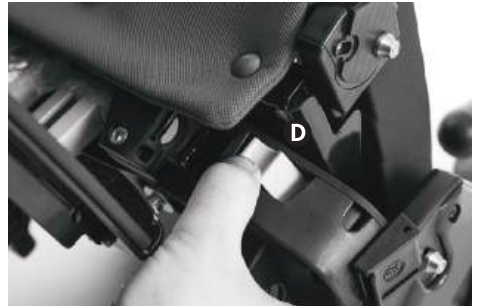

Locate the right and left grey locking latch release buttons at the front of the seat **C**. Simultaneously rotate the buttons towards the centre of the seat **D**, and then press inwards, **E**. An audible click will be heard when the latches release.

Image of locking latch locked

Once the locking latches are released the seat base can be placed on the chassis. Lift the seat base with both hands at either side of the seat base. On the rear of the seat base there are two hooks **F**, which are to be aligned with the rear tube of the chassis interface **G**. Rotate the front of the seat down **H**, pressing down firmly until an audible click of the locking latches locking is heard.

Check that it is secure by pulling up on the front and rear of the seat core.

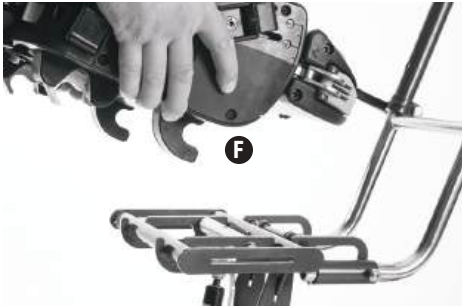

Always ensure the seat base is attached securely.

Use caution when attaching seat as there could be possible finger nip.

To detach the seat, locate and release the locking latches as shown in **C**, **D** and **E**. Then reverse the attachment steps by following **H**, **G** and **F**.

SECTION 16.2: ATTACHING AND DETACHING EXTENDABLE PUSH HANDLE (SMALL AND MEDIUM CHASSIS HIGH-LOW ONLY)

The push handle is attached to the high-Low chassis by inserting the two lower stems into the receiving tubes as shown. The push handle has safety poppers **A**, which need to be pressed in when inserting the lower stems. Push the stems in until the poppers protrude from the other end of the receiving tubes **B**. Secure the handle in place by tightening the locking bolts **C**.

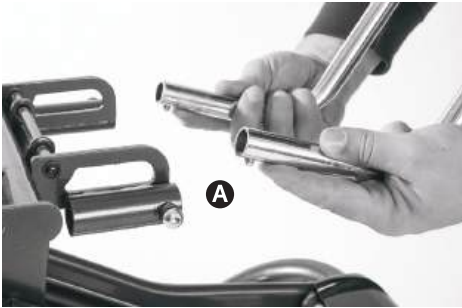

To detach the handlebars, reverse step **C**, then press in the safety poppers **D**, and pull the handlebar tubes out of the lower stems.



Check these regularly to make sure the knobs are tight, particularly if you are moving the product unit along corridors that may have uneven or sloping surfaces.

SECTION 16.3: ATTACHING AND DETACHING FEMORAL BARS

First, secure the hardware into the front two curved slots on the underside of the seat base **A**. Ensure the split washer **B**, goes between the larger plane washer and the head of the bolt. Place the locking plate **C**, between the moulding and the nut. Secure the nut in place so that the end of the bolt sits flush with the end of the nut. The locking plate should be free to move along the bolt between the moulding and the nut. Orientate the locking plate so that a short age faces forward.

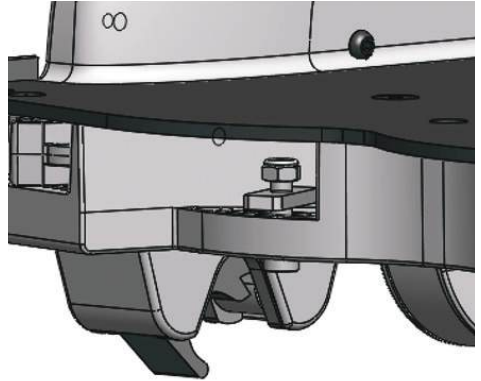
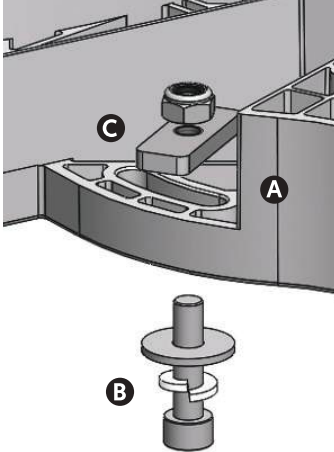

The femoral bar assemblies come in a left and right pair. Ensure the left and right are assembled with the flush side towards the outside of the seat **D**.



Insert the femoral bar into the cavity in the seat base **E**, ensuring that the locking plate is retained within the femoral bar. Insert the countersunk screw into the seat base cover plate **F**, and secure underneath with the nut supplied, and retained within the recess in the moulding. Repeat for the other side.

SECTION 16.4: ATTACHING AND DETACHING LEG STEM

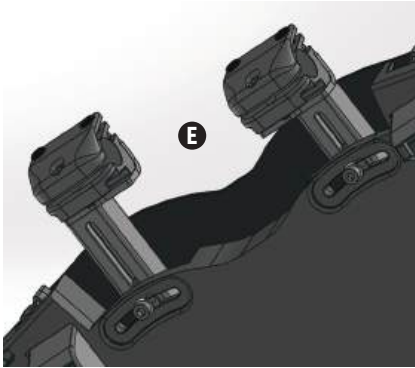

Before attaching the upper leg stem **A**, ensure the clamp **B**, is loosened. Then slot the round boss of the upper leg stem into the clamp from the inside face and re-tighten the clamp **B**, using the Allen key.

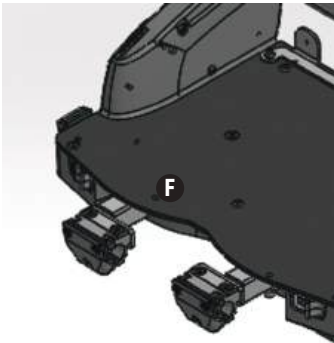

To detach the femoral bars, reverse the process.

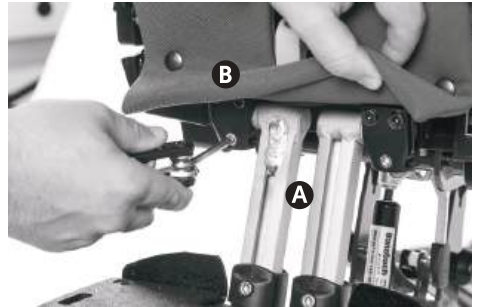

It may be required to adjust the position of the femoral bar to allow for the upper leg clamp to be inserted. To do this, loosen the bolt **C**, on the underside of the seat base, and move to a suitable position. In some setups, it may also be required to remove the seat plate as described in Section 16.5 'Attaching and Detaching Basic, Split and Contoured Seat'.

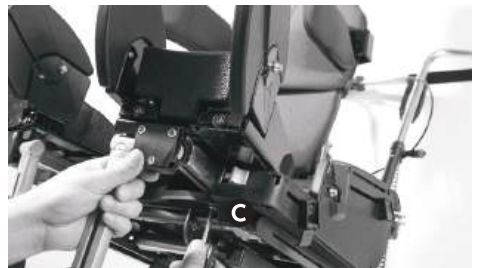

To detach the upper leg stem, reverse the process.

SECTION 16.5: ATTACHING AND DETACHING BASIC, SPLIT AND CONTOURED SEAT HARDWARE

The front seat plate of the basic, split and contoured seats secures to the receivers on the seat base. First locate the downward pointing prongs at the front of the seat plate, **A**, and the upper slot in the receivers **B**, at the end of the femoral bars. Slot the prongs into the left and right receivers, ensuring the two holes on each side align. It may be required to adjust the position of the femoral bar to allow for the receivers to be positions correctly. To do this, loosen the bolt **C**, on the underside of the seat base, and move to a suitable position. Once the seat plate prongs are located, securely tighten using the 4 bolts, **D**, and the Allen key.

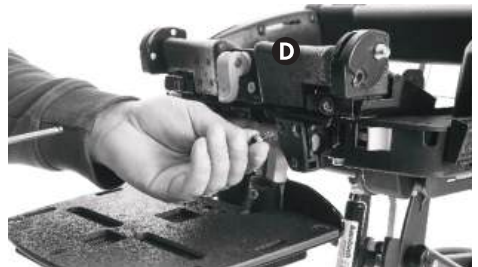
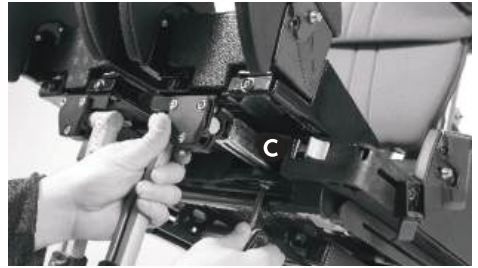
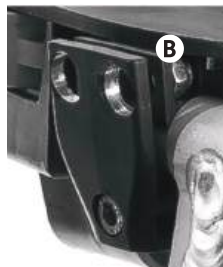

To detach the seat plate, reverse the process.

SECTION 16.6: ATTACHING AND DETACHING THE CONTOURED SEAT

The contoured cushion assembly is secured to the seat plate using Velcro, located on the underside of the contoured cushion assembly, **A**, and the top surface of the seat plate **B**.

Images required, including velcro, and alignment at front.

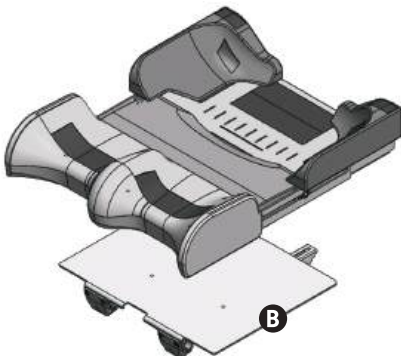
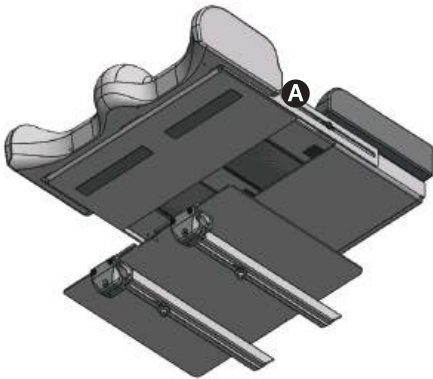

To attach the contoured seat to the seat base, align the front of the seat base platework with the front of the contoured seat foam. Press down to secure the Velcro.

To detach the contoured seat, reverse the process.

SECTION 16.7: ATTACHING AND DETACHING BACKREST

To attach the backrest, locate the backrest receiver at the back of the seat base **A**. Open up the receiver lock paddles **B**, at the back of the seat base by pulling **horizontally outwards** on the paddles and then rotating upwards.

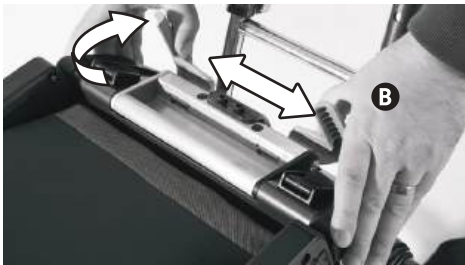

Place the base of the backrest **C**, into the receiver, ensuring it is as deep into the receiver as it can go. Rotate the paddles downwards **D**, and push inwards **E**, to secure the backrest in place.

Check that it is secure by pulling up on the backrest and moving it forward and back.

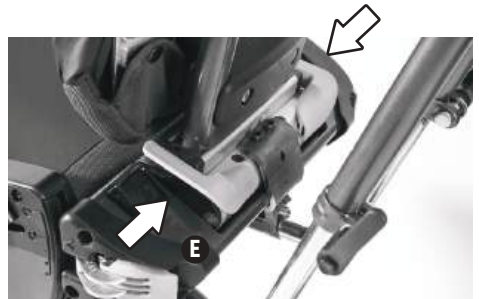
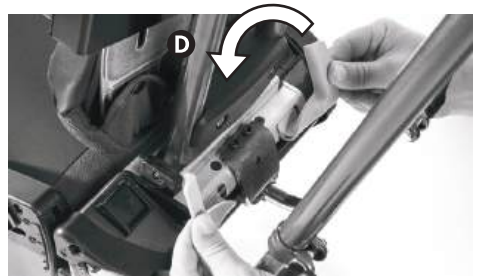

To detach the backrest, reverse the process.



Always ensure the seat base is attached securely

SECTION 16.8: ATTACHING AND DETACHING FOOTREST

To attach the footrest, orientate the locking plate within the lower leg stem **A**, so that the short edge faces forward. Slot the lower leg stem over the end of the upper leg stem **B**, ensuring that the locking plate is retained within the upper leg stem extrusion. Secure in place with the bolt **C**, using the Allen key. The individual footrests can be attached independently, whereas the single footplate requires both lower leg stems to be slotted onto the upper leg stems simultaneously **D**.

To detach the footrest, reverse the process.



Always make sure the foot plate is attached firmly.

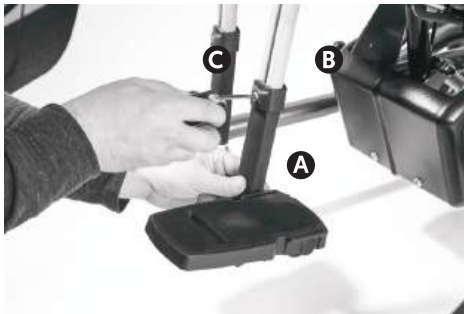

SECTION 16.9: ATTACHING AND DETACHING ARMREST

To attach the armrest, locate the slot on the sides of the seat base **A**, and orientate the armrest with the adjustment cam levers facing outwards **B**. Place the armrest stem into the slot and push downwards **C**. Check that the armrest has self-locked by pulling upwards on the armrest.

To detach the armrest, slide the release button towards the front of the seat **D**, and pull the armrest out of the slot **E**.



SECTION 16.10: ATTACHING AND DETACHING SANDALS

Insert the required attachment bolt **A**, along with the retention plate **B**. Place a rubber lid, **C**, on both the top and bottom of the sandal. Fasten using the four screws **D**, provided. To remove or replace the attachment bolt, reverse this process.

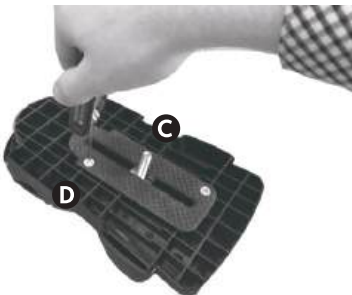
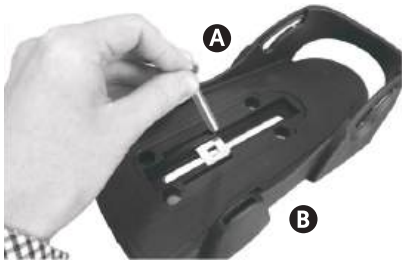

To detach the attachment bolts on sandals, reverse the process.

To attach the sandal **A**, place it on the footplate **B**, so that the attachment bolt, **C**, goes through the slot in the footplate. To secure, place the rubber washer, metal washer, and knob **D**, onto the attachment bolt on the underside of the footplate, and tighten.

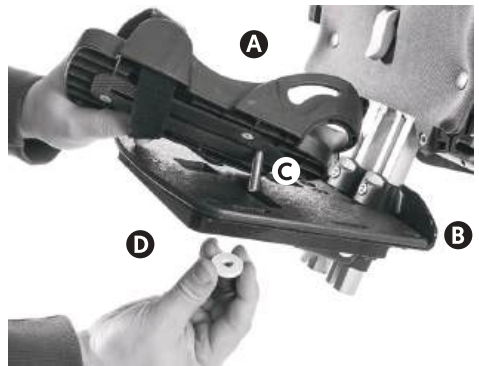

To detach the sandals, reverse the process.

SECTION 16.11: ATTACHING AND DETACHING ANKLE HUGGERS

To attach the ankle huggers, slide the webbing through the side slot in the sandal
A. Loop the webbing back up and through the bottom and then top of the triglide
B. Finally, to lock the webbing in place, pass it through the bottom of the triglide again **C**.
Trim strap to required length.

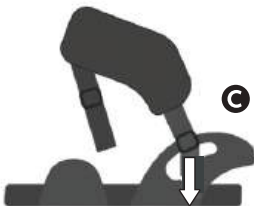
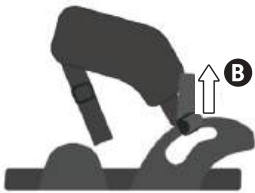
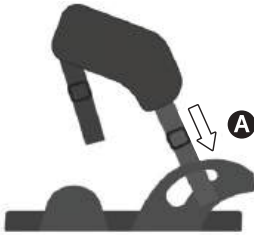

To detach the ankle huggers, reverse the process.

You can also attach the ankle huggers to a single or two-piece piece footplate. Slot the webbing through the slots and secure with the tri-glide supplied with all ankle huggers.



SECTION 16.12: ATTACHING AND DETACHING ANKLE WRAPS

To attach the ankle wrap, feed the lower **A**, and upper **B**, poppers of the ankle wrap under and over the back arch of the sandal and snap together **C**.



Feed the triglide **D**, which is attached to the black and white webbing, through the side slot of the sandal. Feed the black and white Velcro webbing strip **E**, through the opposite slot in the sandal. Feed the end of this webbing through the triglide and double back to secure in place against the Velcro **F**.



To detach the ankle wraps, reverse the process.

SECTION 16.13: ATTACHING AND DETACHING BOOTIES

To attach the booties, slide the webbing through the slots on the one-piece footplate, and secure using tri-glide provided



SECTION 16.14: ATTACHING AND DETACHING LATERAL BRACKET – BASIC BACKREST

To attach the lateral bracket to the basic backrest, place the t-nut **A**, into the vertical slot from the front side of the backrest platework. If the backrest cushions are in place, they can be stretched out of the way. Mesh the two side of the radial [crocodile teeth circular pieces] clamps together **B**, and locate the protrusion into the slot in the bracket. Locate the opposite protrusion of the radial clamp into the slot of the backrest, ensuring the radial clamp sits flush with the surface of the platework **C**. Ensure the t-nut nests between the two surfaces of the radial clamp at the front of the backrest **D**.

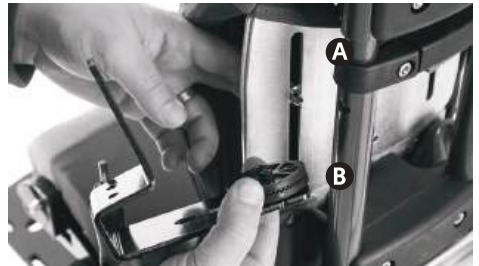

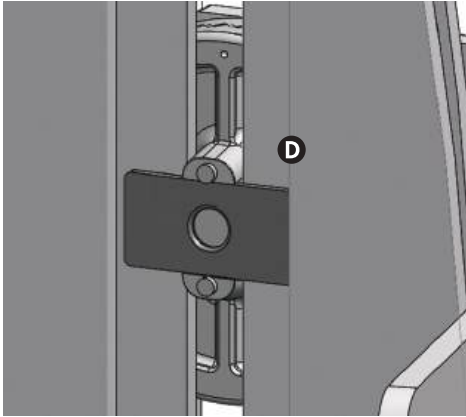

Place the split washer, then the plane washer onto the bolt and pass it through the hole in the radial clamp **E**, engaging the threads of the t-nut. Secure in place with the Allen key.



To detach the lateral bracket, reverse the process.

SECTION 16.15: ATTACHING AND DETACHING LATERAL BRACKET – MODERATE AND COMPLEX BACKREST

To attach the lateral bracket to the moderate and complex backrest, place the t-nut **A**, into the slot in the lateral bracket. Mesh the two sides of the radial clamps together and locate the protrusion of the radial clamp into the slot in the opposite side of the lateral bracket, **B**. Ensure the t-nut nests between the two surfaces of the radial clamp **C**.



Place the split washer, then the plane washer onto the bolt and pass it through the vertical slot at the back of the thoracic moulding **E**, engaging the threads of the t-nut. Secure in place with the Allen key.



To detach the lateral bracket, reverse the process.

Place the radial clamps into the recess at the front of the thoracic moulding **D**, ensuring the protrusion of the radial clamp drops into the vertical slot. If the backrest cushions are in place, they can be moved out of the way.

SECTION 16.16: ATTACHING AND DETACHING SLIM LATERAL

To attach the slim lateral to the lateral bracket, first place the machined boss into the corresponding slot in the slim lateral plastic pad **A**. Position this assembly against the inside surface of the lateral bracket, so that the bracket locates into the recess of the plastic pad and the machined part locates in the slot of the lateral bracket **B**.

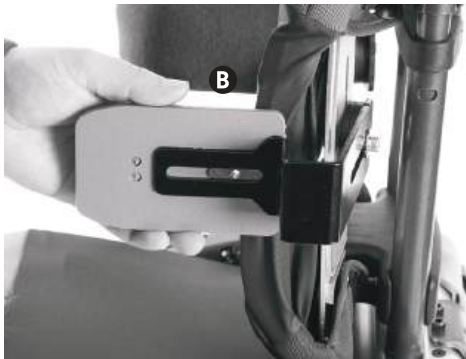
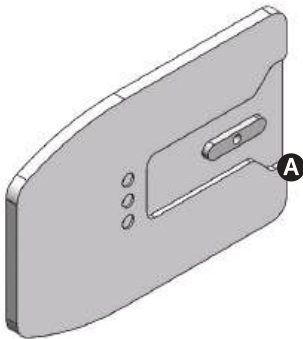

Place the split washer, then the plane washer onto the bolt and pass it through the threaded hole in the machined part **C**. Secure in place with the Allen key.



To detach the slim lateral, reverse the process.

SECTION 16.17: ATTACHING AND DETACHING COMPLEX LATERAL

To attach the complex lateral to the lateral bracket, first place the nut into the recess of the lateral plastic moulding **A**. Position this assembly against the inside surface of the lateral bracket, so that the bracket locates into the recess of the plastic moulding **B**.

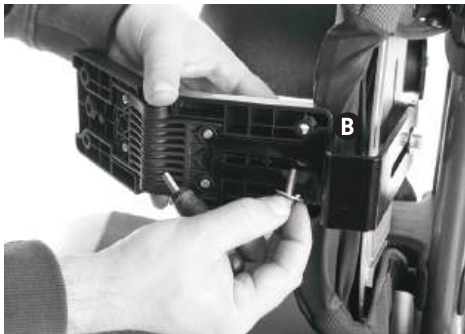

Place the split washer, then the plane washer onto the bolt and pass it through the hole in moulding **C**, engaging the threads of the nut. Secure in place with the Allen key.



To detach the complex lateral, reverse the process.

SECTION 16.18: ATTACHING AND DETACHING FLEXIBLE LATERAL

Attaching the flexible lateral requires the same hardware as the slim lateral. To attach the slim lateral to the lateral bracket, first place the machined boss into the corresponding slot in the slim lateral plastic pad **A**. Position this assembly against the inside surface of the lateral bracket, so that the bracket locates into the recess of the plastic pad and the machined part locates in the slot of the lateral bracket **B**.

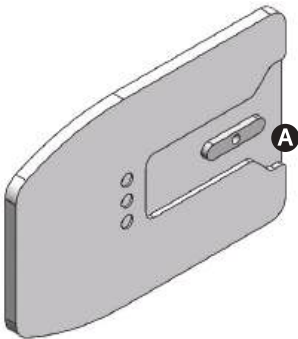

Place the split washer, then the plane washer onto the bolt and pass it through the threaded hole in the machined part **C**. Secure in place with the Allen key.

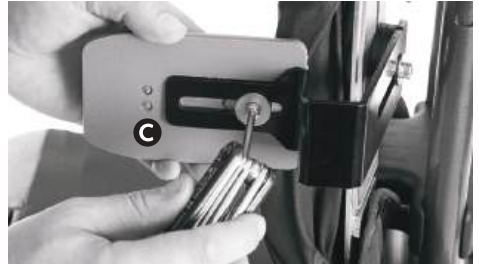

To detach the slim lateral, reverse the process.

SECTION 16.19: ATTACHING AND DETACHING PROTRACTION PAD

To attach the protraction pad, align the two holes of the protraction pad platework with the corresponding holes of the lateral bracket, **A**, ensuring the bend in the platework points away from the lateral pad. Place the two bolts through these holes and secure in place on the far side with two nuts, using the Allen key and a spanner **B**.

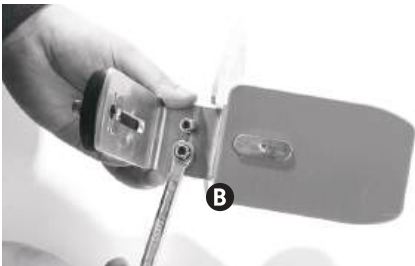
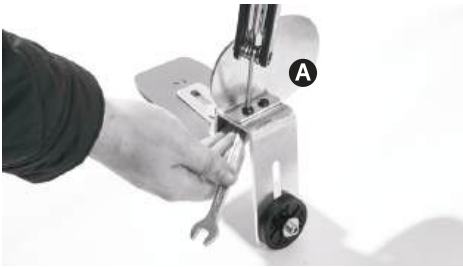

To detach the protraction pad, reverse the process.

SECTION 16.20: ATTACHING AND DETACHING HIP GUIDES (BASIC BACKREST)

To attach the hip guides to the basic backrest, place the t-nut **A**, into the hole at the front of the basic backrest platework, ensuring the long edge of the t-nut is in line with the rectangular plate. Place the bracket into the recess at the back of the basic backrest platework **B**. If the backrest cushions are in place, they can be moved out of the way.

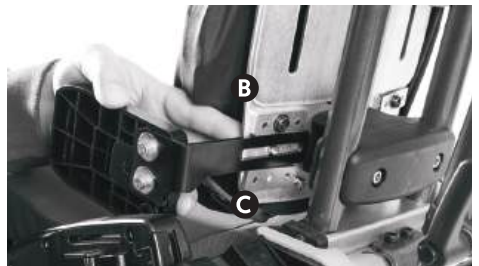
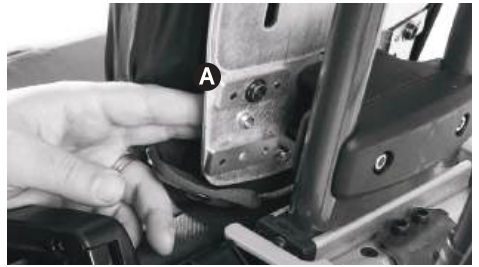

Place the split washer, then the plane washer onto the bolt and pass it through the slot **C**, engaging the threads of the t-nut. Secure in place with the Allen key.

To detach the hip guide, reverse the process.

SECTION 16.21: ATTACHING AND DETACHING HIP GUIDES (MODERATE AND COMPLEX BACKREST)

To attach the hip guides to the moderate and complex backrest, place the t-nut **A**, into the slot at the front of the hip guide bracket. Place the bracket into the recess in the front of the sacral moulding **B**, ensuring the short edges of the t-nut are in line with the top and bottom surfaces of the recess. If the backrest cushions are in place, they can be moved out of the way.

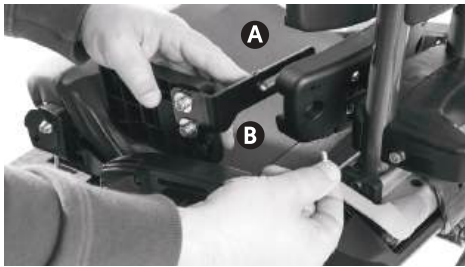

Place the split washer, then the plane washer onto the bolt and pass it through the hole at the back of the sacral moulding **C**, engaging the threads of the t-nut. Secure in place with the Allen key.

To detach the hip guide, reverse the process.

SECTION 16.22: ATTACHING AND DETACHING SMALL BASIC BACKREST SPACER

To attach the small basic backrest spacer, remove the cushion cover from the backrest and remove the four screws, top and bottom, **A**, to separate the backrest platework from the clamps. Secure the spacers using the four longer screws onto the top and bottom clamps **B**.

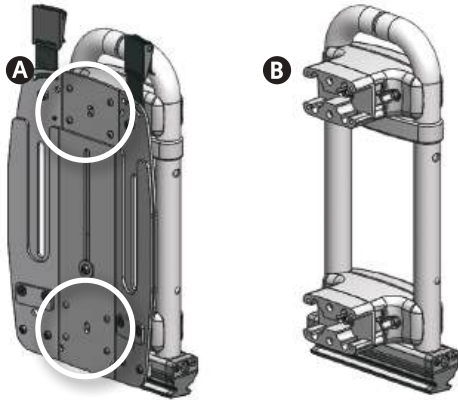

Place the back plate pacer **C**, onto the front surface of the lower clamp moulding **D**. Reattach the backrest platework by securing the four screws, top and bottom **A**.

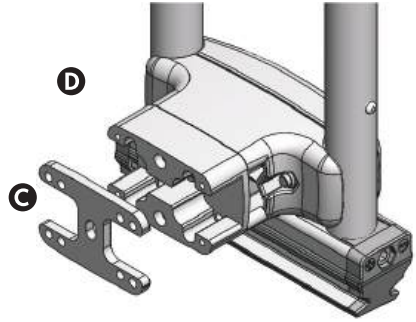

To detach the small basic backrest spacers, reverse the process. This should only be done once before it is required to replace the basic backrest clamps also.

SECTION 16.23: ATTACHING AND DETACHING HEADREST

To attach the headrest, ensure the clamp is open by loosening the bolt and releasing it from the other side of the clamp **A**. Place the clamp over the top bar of the backrest **B**, and centralise.

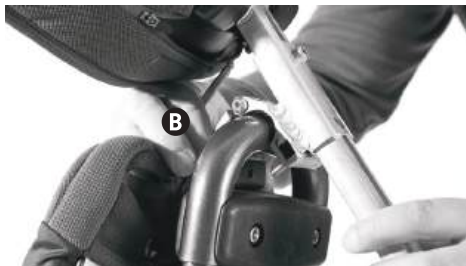
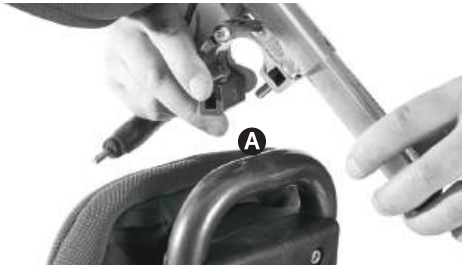

Clamp together by accessing the head of the bolt through the hole on the outside surface of the extrusion **C**, and placing the end of the bolt through the hole in the other half of the clamp, engaging the threads of the nut. The nut is retained within the extrusion and may need to be realigned with the hole. Tighten using the Allen key.



To detach the headrest, reverse the process.

SECTION 16.24: ATTACHING AND DETACHING UNIVERSAL HEADREST BRACKET

To attach the universal headrest bracket, ensure the clamp is open by loosening the bolt and releasing it from the other side of the clamp **A**. Place the clamp over the top bar of the backrest **B**, and centralise.

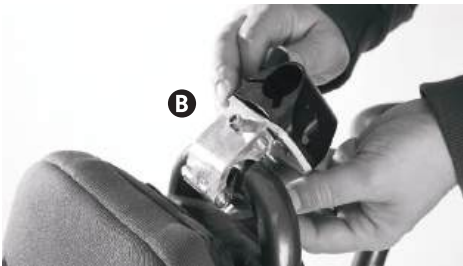
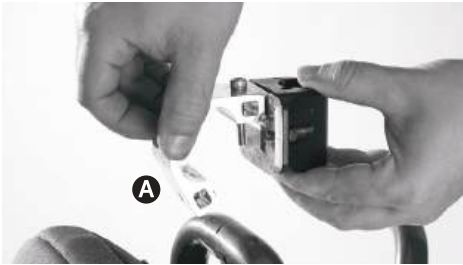

Clamp together by placing the end of the bolt **C**, through the hole in the other half of the clamp, engaging the threads of the nut. The nut is retained within the extrusion and may need to be realigned with the hole. Tighten using the Allen key.



To detach the universal headrest bracket, reverse the process.

SECTION 16.25: ATTACHING AND DETACHING UNIVERSAL HEADREST BRACKET

To attach the universal headrest, place the sleeve **A**, into the receiving bracket **B**. Slide the stem **C**, into the sleeve **D**, and secure using the hand lever **E**.

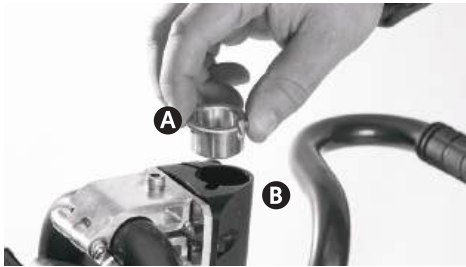

To detach the universal headrest, reverse the process.

SECTION 16.26: ATTACHING AND DETACHING WHITMYER HEADREST

To attach the Whitmyer headrest, slide the stem **A**, into the receiving bracket **B**. Secure using the hand lever **C**.



To detach the Whitmyer headrest, reverse the process.

SECTION 16.27: ATTACHING AND DETACHING TRAY

Before inserting the tray, ensure that the cam lever **A**, located at the front of each armrest is open.

To attach the tray, insert the tray tubes through the centre of the armrest **B**, ensuring that the tray tube protrude out the other side of the receiver **C**. Once the tray is in the desired position the cam lever **A**, should be tightened securely.

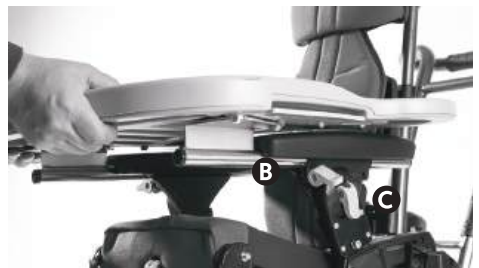
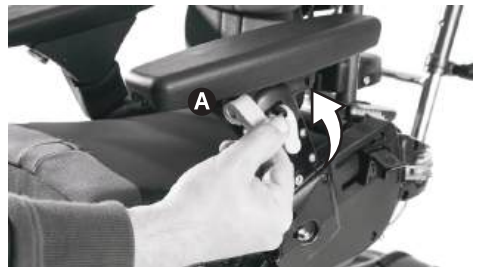

Always use caution to ensure the child's hands or arms do not become trapped when inserting the tray.

Never use the tray to steer or push the chair.

Do not place objects, hotter than 40 degrees Celsius (104 degrees Fahrenheit) on the tray.

Please note that the tray is for the use of the user only. Do not lean or place objects on the tray, greater than 8kgs (17.6lbs).



Please be aware of the gap on the underside of the Tray where a child could insert their finger between the metal bracket and the base of the plastic tray.

To detach the tray, reverse the process.

SECTION 16.28: ATTACHING AND DETACHING BUTTERFLY HARNESS

To attach the butterfly harness, first locate the cam buckles at the top rear area of the backrests **A** which are visible through openings in the cushions. Pass the webbing through the cam buckle and secure in place by clamping down **B**.

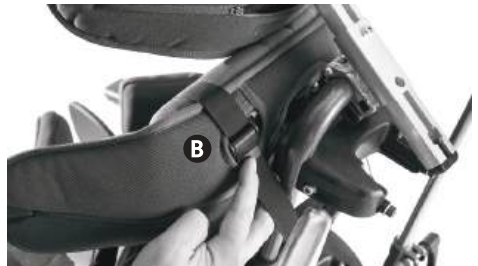

The bottom connection points are on the back of the seat base **C**. Pass the webbing through the cam buckle **at the back of the seat core** and secure in place by clamping down **D**.

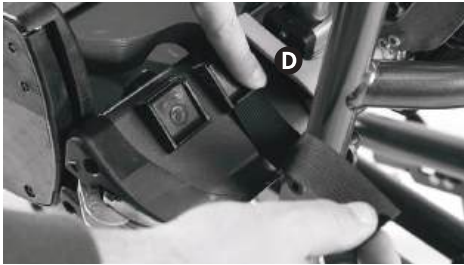
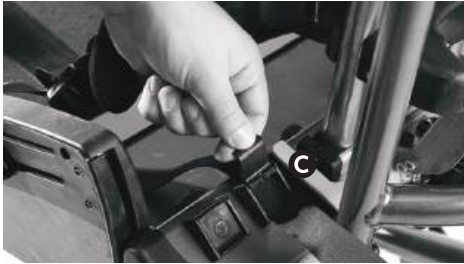

To detach the chest harness, reverse the process.

SECTION 16.29: ATTACHING AND DETACHING RAIN CANOPY

To attach the rain canopy, the rain canopy backrest tube needs to be installed. To remove the existing backrest tube, loosen the bolts of the backrest height adjustment clamp, **A**, and raise the tube up to the maximum height. Press in the poppers **B**, at the sides of the tube and lift to full release the backrest tube.



Loosen the bolts of the shoulder pad clamp, **C**, and slide off the backrest tube. Slide the shoulder pad clamp onto the rain canopy backrest tube and secure the bolts **D**.

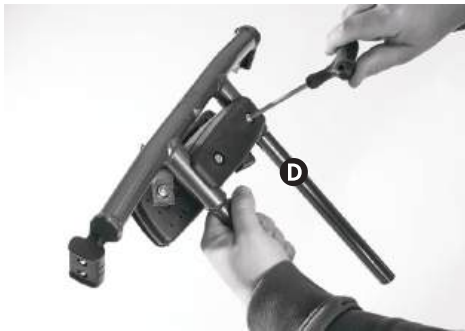

Place the ends of the backrest tube into the receivers of the backrest height clamp. Press in the poppers **E**, at the sides and push the backrest tube down further. Tighten the bolts of the backrest height adjustment clamp **F**.



To attach the rain canopy, slide the connectors down and over the receiver **G**, and rotate the clip inwards **H**, to snap into position.





SECTION 16.30: ATTACHING AND DETACHING PADDED TRAY COVER

To attach the padded tray cover, first remove the tray from the seat. Undo the Velcro straps and slot the padded cover **A**, over the plastic tray **B**. To secure, overlap the Velcro straps **C**, on the underside of the tray. When in place the top of the tray should be fully covered **D**.



To detach the rain canopy, reverse the process.



To detach the padded tray cover, reverse the process.

SECTION 16.31: ATTACHING AND DETACHING ELBOW BLOCKER

To attach the elbow blockers, first remove the tray from the seat. Remove the two washers and bolts **A**. Position the elbow blocker bracket **B**, so that the edge of the pad rests on the top surface of the tray **C**, and align the holes. Reattach the two bolts and washers **D**, and secure using the Allen key.

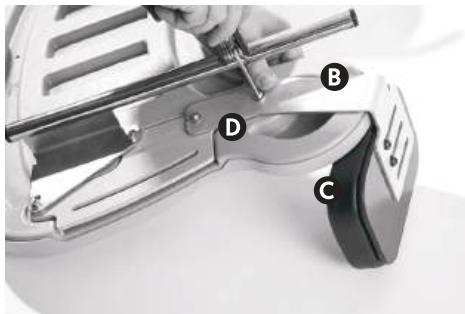

To detach the elbow blocker, reverse the process.

The elbow blockers can be installed on both the standard and padded tray.



SECTION 16.32: ATTACHING AND DETACHING 4-POINT BELT

To attach the 4-point belt, pass the grey webbing **through the upper slot** in the seat moulding **A**, and then through the cam buckle **B**. Pass the black webbing through the cam buckle at the front **C**. Pull the webbing taught and secure the cam buckles. Ensure belt is orientated with padding facing towards child.



Attach the buckle **D**, at the front to secure the user.

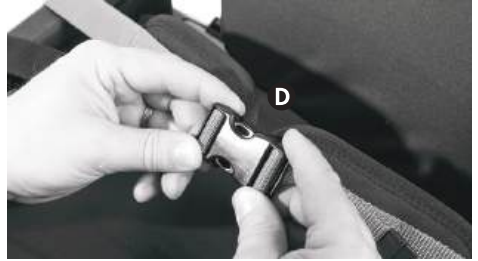

Always attached the pelvic strap first before making any other adjustments.

To detach the 4-point belt, reverse the process.



Safety Information: You must ensure when using the 2-point belt that the webbing is fed through the slot in the seat core.



SECTION 16.33: ATTACHING AND DETACHING 2-POINT BELT

To attach the 2-point belt, pass the grey webbing through the upper slot in the seat moulding **A**, and then through the cam buckle **B**. Pull the webbing taught and secure the cam buckles. Ensure belt is orientated with padding facing towards child.

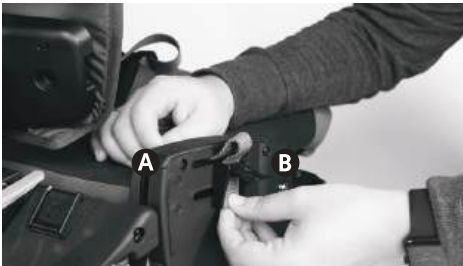

Attach the buckle **C**, at the front to secure the user.



To detach the 2-point belt, reverse the process.



Safety Information: You must ensure when using the 2-point belt that the webbing is fed through the slot in the seat core.



Always attached the pelvic strap first before making any other adjustments.

SECTION 16.34: ATTACHING AND DETACHING PELVIC CRADLE

Place the on the seat base cushion **B**. The pelvic cradle is labelled to indicate the correct orientation. Attach the rear Velcro strap up into the cavity within the thoracic backrest cushion **C** (moderate and complex backrests).

Pass the black webbing through the cam buckles at either side of the **front** of the seat, **D**, and secure the cam buckles. Pass the grey webbing through the cam buckles at either side of the back of the seat **E**, and secure the cam buckles.



To attach the pelvic cradle to a basic backrest, trim the rear Velcro strap to the level of the top of the pelvic cradle. Secure as per **A**, **B**, **D** & **E**.

Attach the buckle **F**, at the front to secure the user.



Always attached the pelvic strap first before making any other adjustments.



Always secure the pelvic harness or Pelvic Cradle first before fastening other buckles or harnesses. Adjust the harness so the child cannot slide or creep forward in the seat.

To detach the pelvic cradle, reverse the process.

SECTION 16.35: ATTACHING AND DETACHING DYNAMIC BACK

To attach the dynamic backrest, the static backrest plate must first be removed. Remove the two top and back bolts **A**, and remove the cover moulding. Remove the central bolt, **B**, and the static backrest plate **C**.

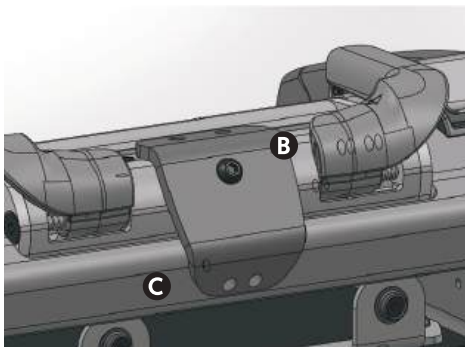
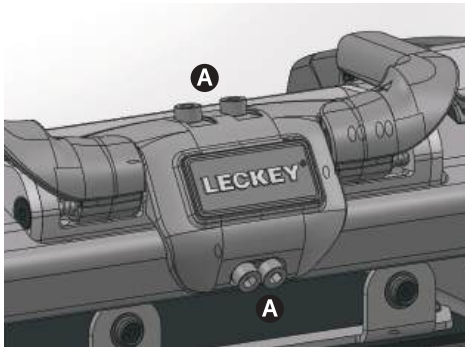

Align the holes of the aluminium bracket of the dynamic back assembly **D**, with the holes on the seat base. Secure using the five bolts provided **E**.

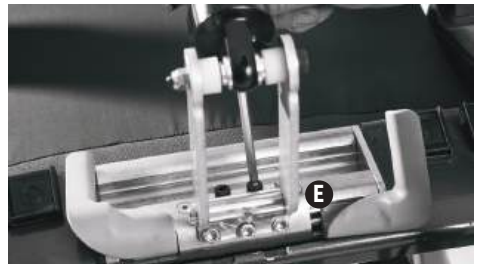
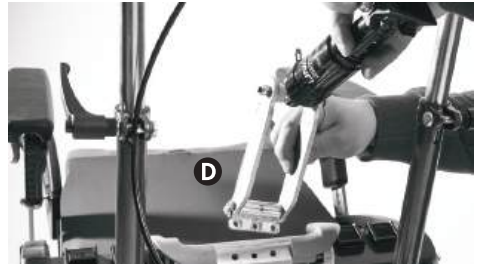

Rotate the dynamic back assembly around so that the holes in the aluminium block align, and secure using the two bolts provided **F**.



Use caution when assembling and fitting the dynamic backrest as there is a minor risk of finger nipping.

SECTION 16.36: ATTACHING AND DETACHING SHOULDER WING UPGRADE (MODERATE BACKREST ONLY)

To attach the shoulder wing upgrade the shoulder blank moulding must first be removed by unscrewing the 3 screws holding it in place **A**, using the Allen key. Remove the shoulder blank moulding **B**, and replace with the shoulder wing upgrade **C**, ensuring that it is orientated in such a way that the head of the bolt **D**, is pointed upwards. Secure in place with the 3 screws **E**, using the Allen key. Do not overtighten.

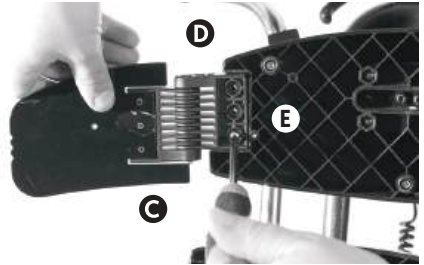

To detach the shoulder wing upgrade, reverse the process.



SECTION 16.37: ATTACHING AND DETACHING SHOULDER ANGLE SPACER (MODERATE BACKREST ONLY)

To attach the angled shoulder spacer, remove the cushion cover from the shoulder moulding and remove the four screws to separate the moulding from the clamp **A**. Place the back plate spacer **B**, onto the front surface of the clamp moulding **C**.

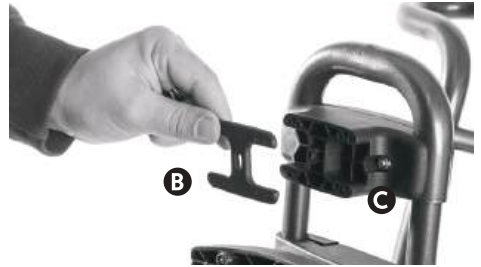
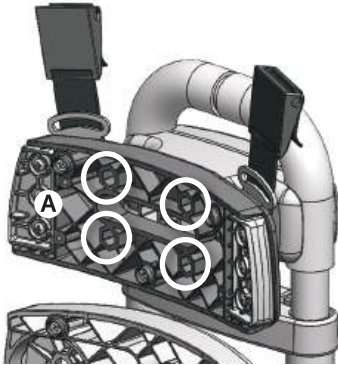

Secure the angled shoulder spacer using the four longer screws **D**. Reattach the shoulder moulding by tightening the screws **E**, into the angled shoulder spacer.

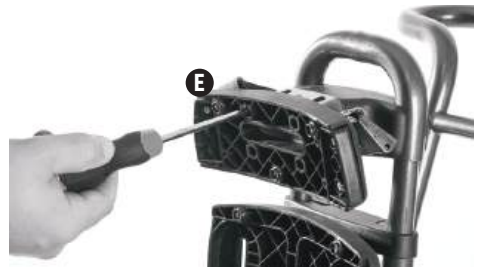

The process should not be reversed using the same hardware. To remove the spacer, a new basic backrest clamp will be required.

SECTION 16.38: ATTACHING AND DETACHING POMMEL

The pommel attaches to the basic seat only. To attach the pommel, open the cam lock at the front of the seat **A**, and place the pommel bracket through the opening in the seat cushion and into the receiver slot on the seat **B**. To secure in place, push down firmly on the cam lock **C**. Orientate the pommel so that it sits external to the seating area.

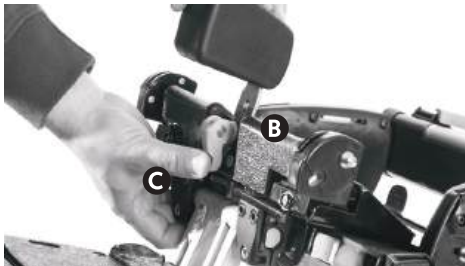

If the attachment mechanism becomes loose over time, it can be tightened by tightening the screw (clockwise) located within the cam lever when in the raised position **A**.



Always remove the pommel before placing the child in the seat.

To detach the pommel, reverse the process.

SECTION 16.39: ATTACHING AND DETACHING FEMORAL GUIDES

To attach the femoral guide, slot the femoral guide stem **A**, into the receiver on the seat **B**, and press downwards. Check that the femoral guide has self-locked by pulling upwards on the femoral guide.

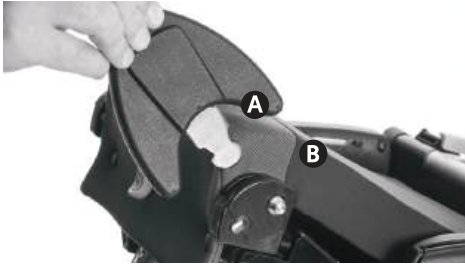

To detach the femoral guide, slide the release button diagonally upwards **C**, and pull the femoral guide out of the slot.



SECTION 16.40: ATTACHING AND DETACHING BACKREST

To attach the backrest, locate the backrest receiver at the back of the seat base **A**. Open up the receiver lock paddles **B**, at the back of the seat base by pulling **horizontally outwards** on the paddles and then rotating upwards.

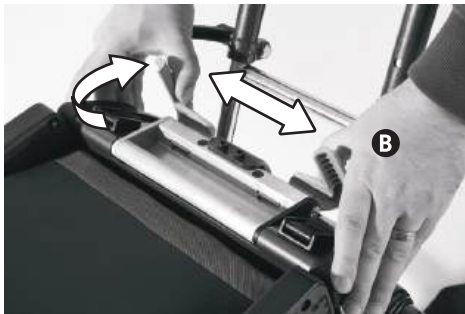

Place the base of the backrest **C**, into the receiver, ensuring it is as deep into the receiver as it can go. Rotate the paddles downwards **D**, and push inwards **E**, to secure the backrest in place.

Check that it is secure by pulling up on the backrest and moving it forward and back.

SECTION 17: FITTING THE UPHOLSTERY

We suggest the cushions are fitted in the following order:

1. **Femoral Covers (Optional)**
2. **Seat Cushion**
 - a. Basic Seat Cushion
 - b. Split Seat Cushion
 - c. Contoured Seat Cushion
3. **Backrest Cushion(s)**
 - a. Basic Backrest (Foam then Cover)
 - b. Moderate or Complex Backrest (3 Piece: sacral, then thoracic, then shoulder)
4. **Pelvic Belt (Cradle, 2-point or 4-Point)**
5. **Hip Pads**
6. **Chest Harness**
7. **Lateral Covers**
8. **Headrest Cover**
9. **Foot Cushion**
10. **Pommel Cover**
11. **Protraction Pad Cover**

SECTION 17.1: ATTACHING AND DETACHING FEMORAL COVERS

To attach the femoral guide cover, slot the cover over the end of the femoral guide **A**. Secure in place with the snap fasteners **B**, at either side of the metal stem.

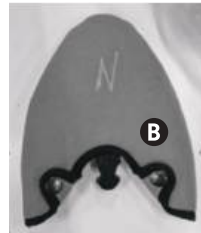

To detach the femoral guide cover, reverse the process.

SECTION 17.2: ATTACHING AND DETACHING BASIC SEAT CUSHION

To attach the basic seat cushion to the back of the seat, locate the row of snap fastener tabs **A**, at the back of the seat base. Slot the fastener tabs between the seat cushion and the webbing **B**, and secure in place with the fasteners **C**.

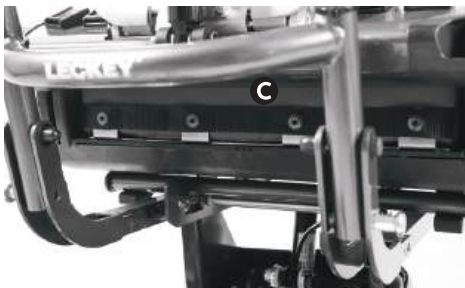
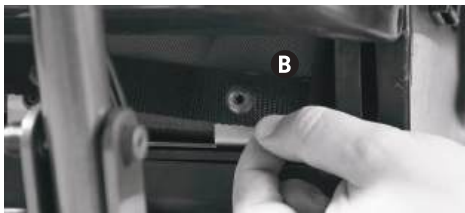
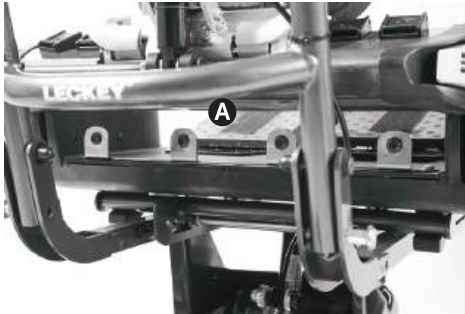

To attach the front of the basic seat cushion, align the front of the cushion with the front of the seat ramps, and press down to Velcro in place. Locate the snap fasteners at the front of the seat base **D**. Drop the front flap of the seat cushion down and secure in place with the fasteners **E**. Ensure there is sufficient access to the pommel lever through the opening in the seat cushion **F**.

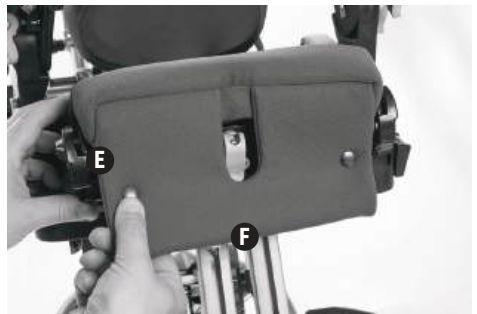

To detach the basic seat cushion, reverse the process.



Always check the seat base cushion is secure before placing the child in the seat.

SECTION 17.3: ATTACHING AND DETACHING SPLIT SEAT CUSHION

To attach the split seat cushion to the back of the seat, locate the row of snap fastener tabs **A**, at the back of the seat base. Slot the fastener tabs between the seat cushion and the webbing **B**, and secure in place with the fasteners **C**.

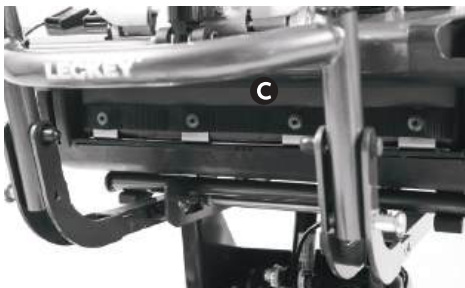
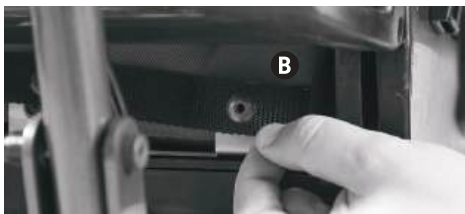
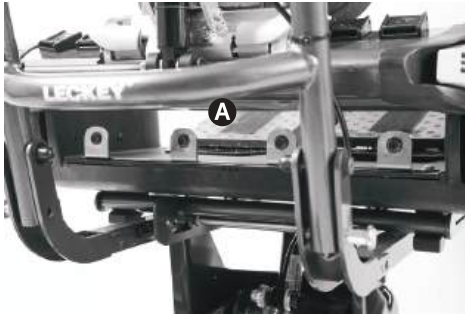

To attach the front of the split seat cushion, align the front of each side of the cushions with the front of each of the seat ramps, and press down to Velcro in place. Locate the fasteners at the front of the seat base **D**. Drop the front flap of the seat cushion down and secure in place with the fasteners **E**.

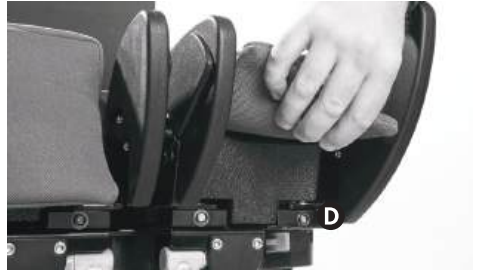

To detach the split seat cushion, reverse the process.



Always check the seat base cushion is secure before placing the child in the seat.

SECTION 17.4: ATTACHING AND DETACHING CONTOURED SEAT CUSHION

To attach the contoured seat cushion, first separate the foam from the fabric cover. Align the front edge of the foam with the first contour of the seat base, and press down to Velcro in place **A**. Stretch the foam so that the back edge of the foam and the back edge of the seat base are aligned, and press down to Velcro in place **B**. Ensure the slots in the foam run from side to side.

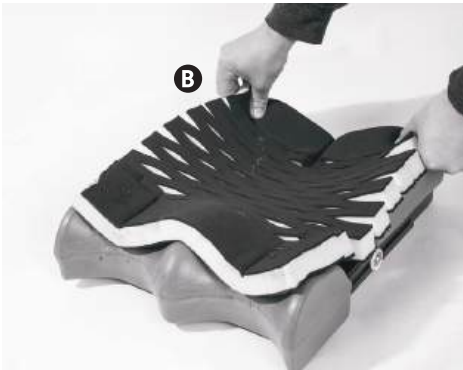

Slide the front of the seat cushion fabric over the front of the seat **C**, and stretch the back section over the back, and press down to Velcro in place **D**.



To detach the contoured seat cushion, reverse the process.



Always check the seat base cushion is secure before placing the child in the seat.

SECTION 17.5: ATTACHING AND DETACHING BASIC BACKREST FOAM

To attach the basic backrest foam, locate the holes at the top and bottom of the foam **A**. Place the washer on the screw **B**, and pass the screw through the holes in the foam and the corresponding holes in the platework **C**.

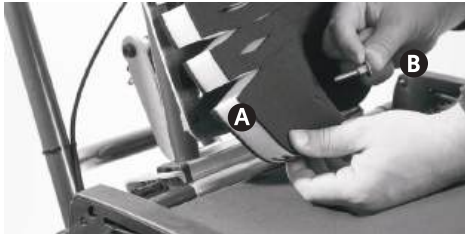

Using a spanner, secure all four screws in place with a nut **D**, so that the end of the screw sits flush with the end of the nut **E**.

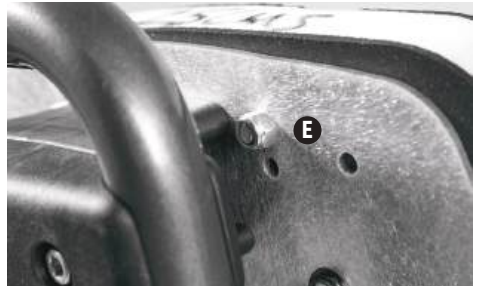
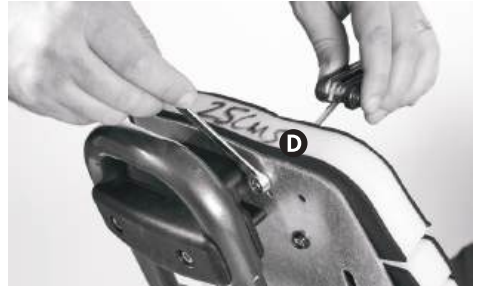

To detach the basic backrest foam, reverse the process.

SECTION 17.6: ATTACHING AND DETACHING BASIC BACKREST COVER

To attach the basic backrest cover, slide the top of the cover over the top of the backrest, **A**, and secure in place with the snap fasteners **B**. There are openings **C**, at either side of the cover for harness connections.



Tuck the stretch fabric in between the foam and the platework **D**, along both sides of the backrest. Slide the bottom of the cover underneath the bottom of the backrest and secure in place with the snap fasteners **E**.



To detach the basic backrest cover, reverse the process.

SECTION 17.7: ATTACHING AND DETACHING SACRAL COVER

To attach the sacral cover, align the cover with the moulding and secure in place with the snap fasteners at the sides **A**, and underneath the moulding **B**.

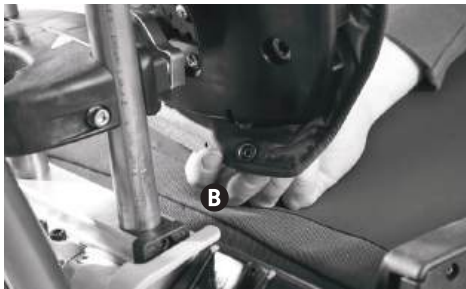
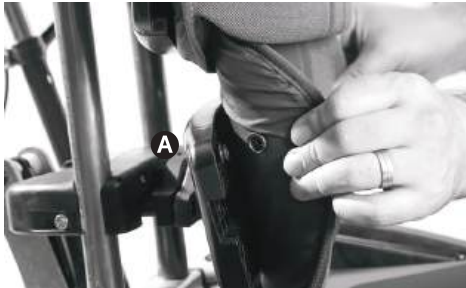

To detach the sacral cover, reverse the process.

SECTION 17.8: ATTACHING AND DETACHING THORACIC BACKREST COVER

To attach the thoracic cover, slot the top of the sacral cover into the cavity on the underside of the thoracic cover **A**. Align the thoracic cover with the moulding and secure in place with the snap fasteners at the top and bottom **B**.



SECTION 17.9: ATTACHING AND DETACHING SHOULDER SECTION COVER

To attach the shoulder cover, slot the top of the thoracic cover into the cavity on the underside of the shoulder cover **A**. Align the shoulder cover with the moulding and wrap the cover over both ends, securing in place with the zips **B**. Ensure the cut-outs at the back of the shoulder cover align with the harness connectors, or allow for the harness connectors to pass through **C**.



To detach the shoulder cover, reverse the process.

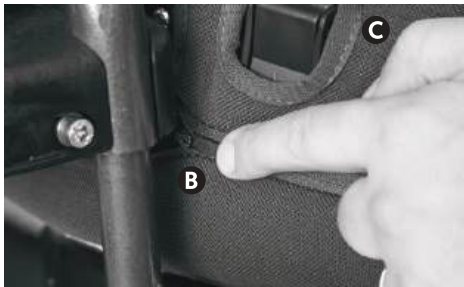

SECTION 17.10: ATTACHING AND DETACHING PELVIC CRADLE

Place cradle on the seat base cushion

B. The pelvic cradle is labelled to indicate the correct orientation. Attach the rear Velcro strap up into the cavity within the thoracic backrest cushion, **C** (moderate and complex backrests).

Pass the black webbing through the cam buckles at either side of the front of the seat, **D**, and secure the cam buckles. Pass the grey webbing through the cam buckles at either side of the back of the seat **E**, and secure the cam buckles.

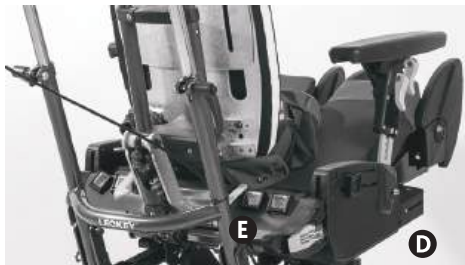

When attaching the pelvic cradle to a basic backrest, you can trim the rear Velcro strap to the level of the top of the pelvic cradle. Secure as per **A**, **B**, **D** & **E**.

Attach the buckle **F**, at the front to secure the user.



Always attached the pelvic strap first before making any other adjustments.



Always secure the pelvic harness or pelvic Cradle first before fastening other buckles or harnesses. Adjust the harness so the child cannot slide or creep forward in the seat

To detach the pelvic cradle, reverse the process.

SECTION 17.11: ATTACHING AND DETACHING HIP PAD COVERS

To attach the hip pad covers, undo the zip and slide the cover over the moulding, with the zip facing outwards. Secure in place with the zip. The internal label will help you identify right and left.



To detach the hip pad cover, reverse the process.

SECTION 17.12: ATTACHING AND DETACHING CHEST/ BUTTERFLY HARNESS

To attach the butterfly harness, first locate the cam buckles at the top rear area of the backrests **A** which are visible through openings in the cushions. Pass the webbing through the cam buckle and secure in place by clamping down **B**.



The bottom connection points are on the back of the seat base **C**. Pass the webbing through the cam buckle and secure in place by clamping down **D**.

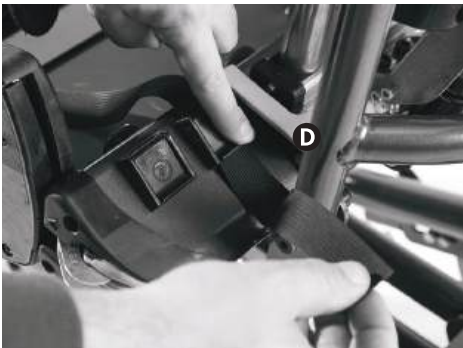

To detach the chest harness, reverse the process.

SECTION 17.13: ATTACHING AND DETACHING LATERAL COVERS - SLIM

To attach the lateral covers, undo the Velcro and slide the cover over the plastic pad **A**, with the Velcro facing downwards. Secure in place with the Velcro **B**.



To detach the slim lateral cover, reverse the process.

SECTION 17.14: ATTACHING AND DETACHING LATERAL COVERS – HINGED HUGGING

To attach the lateral covers, undo the Velcro and slide the cover over the plastic moulding, **A**, with the Velcro facing downwards, and the eyelet upwards. Secure in place with the Velcro **B**.



To detach the hinged hugging lateral cover, reverse the process.

SECTION 17.15: ATTACHING AND DETACHING LATERAL COVERS – FLEXIBLE WRAPAROUND

To attach the flexible lateral covers, undo the Velcro and slide the cover over the plastic pad **A**, with the Velcro facing downwards and the surface with the black webbing facing outwards. Secure in place with the Velcro **B**.



To detach the flexible lateral cover, reverse the process.

SECTION 17.16: ATTACHING AND DETACHING HEADREST COVER

To attach the headrest cover, align the headrest cover with the front of the moulding and wrap the cover over both ends **A**, securing in place with the zips **B**. Ensure to align the cover so that the zip is closest to the bottom edge.



To detach the headrest cover, reverse the process.

SECTION 17.17: ATTACHING AND DETACHING FOOTREST COVER

To attach the footrest cover, first remove any hardware or straps that are attached to the footrest. Place the footrest cover onto the top surface of the footrest, at the rear **A**. Place the cover, over the top surface of the footrest, so that the raised sides of the cover align with the back and sides of the footrest. Secure on the underside using the Velcro straps **B**.



To detach the footrest cover, reverse the process.

SECTION 17.18: ATTACHING AND DETACHING POMMEL COVER

To attach the pommel cover, undo the Velcro and slide the cover **A**, over the plastic pad **B**, with the Velcro facing downwards and with the pad orientated to match the contours of the pad. Secure in place with the Velcro **C**.



To detach the pommel cover, reverse the process.



SECTION 17.19: ATTACHING AND DETACHING PROTRACTION PAD COVER

To attach the protraction pad cover, undo the Velcro and slide the cover **A**, over the platework **B**, with the Velcro facing upwards and the pad orientated so that the solid grey fabric side faces towards the front of the seat. Secure in place with the Velcro, and insert the extension piece into the lateral cover **C**.



To detach the protraction pad cover, reverse the process.

SECTION 17.20: ATTACHING AND DETACHING LATERAL BRACKET COVER

To attach the lateral bracket cover, undo the Velcro and wrap the cover **A**, over the platework **B**, with the Velcro facing downwards and the pad orientated so that the extension tab **C**, points towards the lateral pad and facing outwards. Secure in place with the Velcro **D**, and insert the extension tab into the lateral cover **E**.

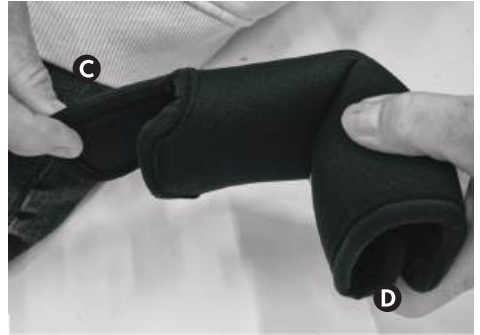

To detach the lateral bracket cover, reverse the process.

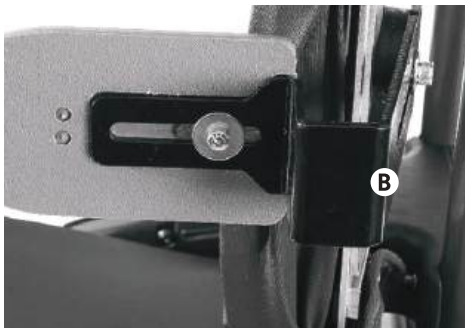

SECTION 18: CLINICAL SETUP FOR POSTURAL MANAGEMENT

The clinical setup of the product should be completed by a technically and clinically competent person who has been trained in the use of the product. Leckey recommend a written record is maintained of all clinical setups for this product. Set the backrest height, seat depth and footplate height before placing the child in the seat. These can be fine-tuned when the child is in the seat.

SECTION 18.1: ADJUSTING SEAT DEPTH ON BASIC SEAT

To adjust the seat depth on the basic seat, loosen the left and right bolts **A**, on the underside of the seat base and move forward and backward to a suitable position. Tighten both bolts to secure in place.



SECTION 18.2: ADJUSTING SEAT DEPTH AND LEG ANGLE (ABDUCTION AND ADDUCTION) ON SPLIT SEAT

To adjust the seat depth and leg angle on the split seat, loosen the left and right bolts **A**, on the underside of the seat base and move each seat leg component separately to a suitable position. The seat leg components can be moved forward, backwards and to 15 degrees abduction/adduction. Tighten both bolts to secure in place.



SECTION 18.3: ADJUSTING SEAT DEPTH ON CONTOURED SEAT

To adjust the seat depth of the contoured seat, first remove the contoured cushion assembly **A**, from the seat base, and remove the covers and foam. Loosen the bolts **B**, at either side of the plate and slide forward and backwards to the desired position. Tighten the bolts to secure in place.



To achieve maximum range of seat depth, the front section should be orientated as shown above. To achieve minimum range of seat depth, remove the bolts **B**, at either side of the seat, and rotate the front section so that the short edge faces upwards **C**. Reattach the front section so that the slider **D**, and slot, **E**, are reengaged on either side. Reattach the bolt with washer at either side of the seat, adjust to the desired position and tighten the bolts to secure in place.

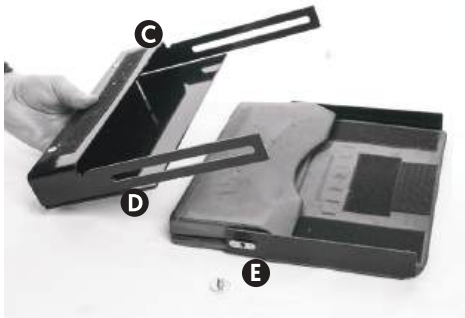

You can also adjust the depth of the base plate to prevent overhang of the contoured seat plate. To adjust the seat depth on the seat plate, loosen the left and right bolts on the underside of the seat base and move forward and backward to a suitable position. Tighten both bolts to secure in place (see 18.1 or 18.2 for pictures).

Reset the front base foam piece **F**, so that it rests up against the front inside surface of the platework. Set the front contoured foam piece **G**, into position, aligning the foam with the front of the platework.



SECTION 18.4: ADJUSTING HIP WIDTH ON CONTOURED SEAT

To adjust the hip width of the contoured seat, the left and right hip pads **A**, can be repositioned on the Velcro base **B**, where the short, dashed lines **C**, aid positioning and alignment. Align the back edge of the pads with the back edge of the platework.

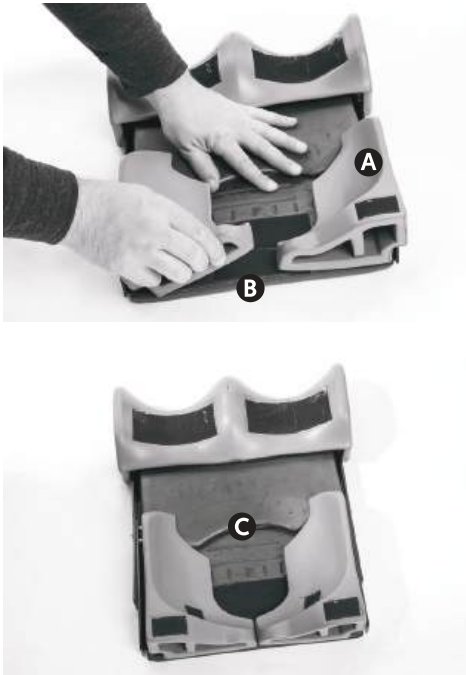

SECTION 18.5: ADJUSTING HIP PAD WIDTH ON BASIC AND SPLIT SEAT (BASIC BACKREST)

To adjust the hip pad width on the basic backrest, release the snap fastener of the backrest cushion to gain access to the adjustment bolt **A**. Loosen the bolt and adjust inward or outward to the desired position. Tighten the bolt to secure in place.

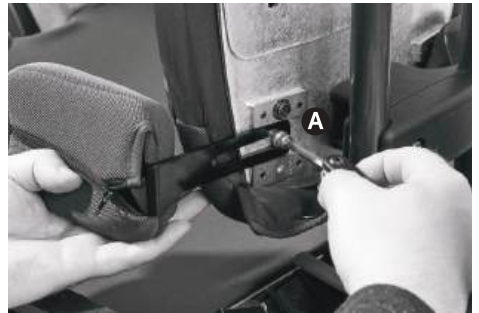

SECTION 18.6: ADJUSTING HIP PAD WIDTH ON BASIC AND SPLIT SEAT (MODERATE AND COMPLEX BACKREST)

To adjust the hip pad width on the moderate and complex backrest, locate the adjustment bolt **A**, at the back of the moulding. Loosen the bolt and adjust inward or outward to the desired position. Tighten the bolt to secure in place.



SECTION 18.7: ADJUSTING HIP PAD HEIGHT AND ANGLE

To adjust the hip pad height, remove the two bolts **A**, and reset into the adjacent hole combinations **B**. Ensure to move the nuts located in the recesses at the back of the moulding down into the corresponding recesses. The hip pad assemblies can also be swapped left to right to achieve additional height options.

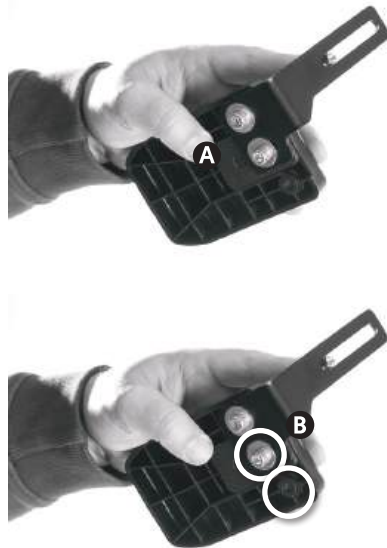

To adjust the hip pad angle, loosen the two bolts **A**, and position at the desired angle. Tighten the bolts to secure in place.

SECTION 18.8: ADJUSTING HEIGHT OF BACKREST

To adjust the height of the backrest, loosen the bolts of the backrest height adjustment clamp **A**, and raise or lower the backrest telescoping tubes to the desired height. To adjust the backrest down from the highest position, press in the snap fastener **B**, at the side of the tube and push downwards. Tighten the bolts of the backrest height adjustment clamp **A**, to secure in position.



SECTION 18.9: ADJUSTING HEIGHT OF INDIVIDUAL PADS ON MODERATE AND COMPLEX BACKRESTS

The moderate and complex backrest pads have two clamp options, the basic or complex clamp.

To adjust the height of the basic clamp, loosen the bolts **A**, and slide the clamp up or down the backrest tubes to the desired position. Tighten the bolts to secure in position.



To adjust the height of the complex clamp, loosen the bolts **B**, and slide the clamp up or down the backrest tubes to the desired position. Tighten the bolts to secure in position.

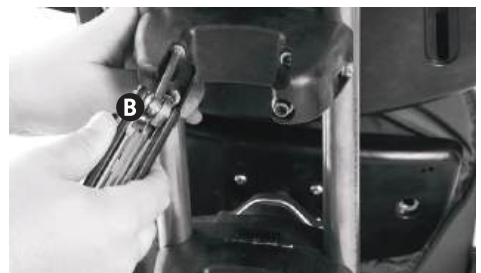

SECTION 18.10: ADJUSTING DEPTH OF SACRAL SECTION (MODERATE AND COMPLEX ONLY)

The complex clamps are found on the sacral, thoracic and shoulder sections of the complex backrest, and on the sacral of the moderate backrest.

To adjust the depth of the complex clamp, loosen the bolt **A**, at either side of the clamp. Adjust the depth by moving the backrest section forwards or backwards to the desired position **B**. Tighten the bolts to secure in position.



It may be necessary to loosen the angle adjustment bolts to achieve depth adjustment, as per 18.11. Ensure both sets of bolts are tightened to secure in position after adjustment.

SECTION 18.11: ADJUSTING ANGLE OF SACRAL SECTION (MODERATE AND COMPLEX ONLY)

The complex clamps are found on the sacral, thoracic and shoulder sections of the complex backrest, and on the sacral of the moderate backrest.

To adjust the angle of the complex clamp, loosen the bolts **A**, of the clamp. Adjust the angle by rotating the backrest section in all axes to the desired position. Tighten the bolts to secure in position.

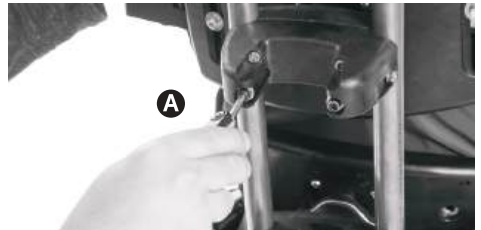

SECTION 18.12: ADJUSTING DEPTH OF MIDDLE BACKREST SECTION (COMPLEX ONLY)

The complex clamps are found on the sacral, thoracic and shoulder sections of the complex backrest, and on the sacral of the moderate backrest.

To adjust the depth of the complex clamp, loosen the bolt **A**, at either side of the clamp. Adjust the depth by moving the backrest section forwards or backwards to the desired position **B**. Tighten the bolts to secure in position.

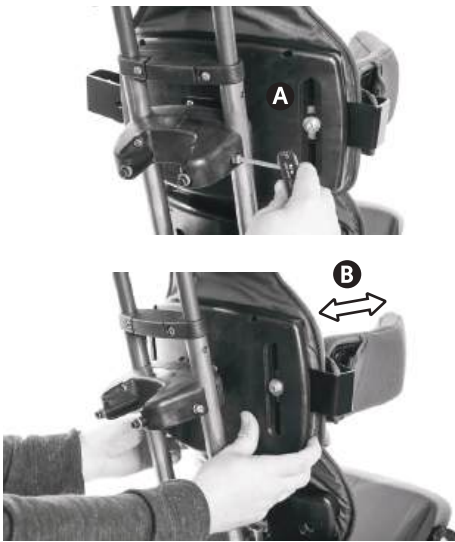

It may be necessary to loosen the angle adjustment bolts to achieve depth adjustment, as per 18.11. Ensure both sets of bolts are tightened to secure in position after adjustment.

SECTION 18.13: ADJUSTING ANGLE OF MIDDLE BACKREST SECTION (COMPLEX ONLY)

The complex clamps are found on the sacral, thoracic and shoulder sections of the complex backrest, and on the sacral of the moderate backrest.

To adjust the angle of the complex clamp, loosen the bolts **A**, of the clamp. Adjust the angle by rotating the backrest section in all axes to the desired position. Tighten the bolts to secure in position.

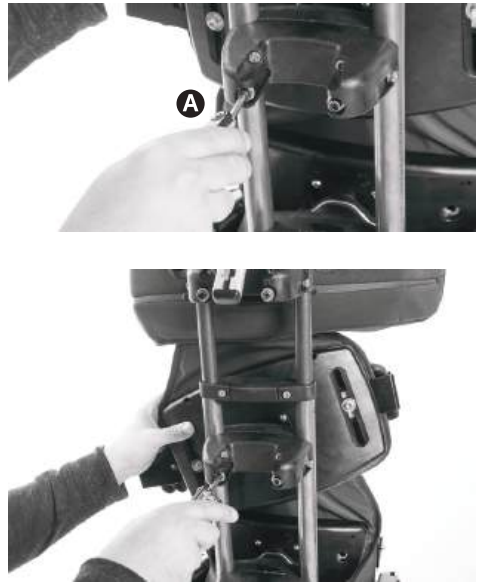

SECTION 18.14: ADJUSTING DEPTH OF SHOULDER SECTION (COMPLEX ONLY)

The complex clamps are found on the sacral, thoracic and shoulder sections of the complex backrest, and on the sacral of the moderate backrest.

To adjust the depth of the complex clamp, loosen the bolt **A**, at either side of the clamp. Adjust the depth by moving the backrest section forwards or backwards to the desired position **B**. Tighten the bolts to secure in position.



It may be necessary to loosen the angle adjustment bolts to achieve depth adjustment, as per 18.11. Ensure both sets of bolts are tightened to secure in position after adjustment.

SECTION 18.15: ADJUSTING ANGLE OF SHOULDER SECTION (COMPLEX ONLY)

The complex clamps are found on the sacral, thoracic and shoulder sections of the complex backrest, and on the sacral of the moderate backrest.

To adjust the angle of the complex clamp, loosen the bolts **A**, of the clamp. Adjust the angle by rotating the backrest section in all axes to the desired position. Tighten the bolts to secure in position.

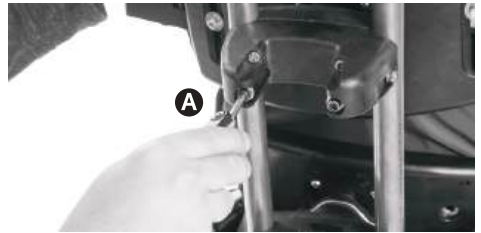

SECTION 18.16: ADJUSTING ANGLE OF SHOULDER WINGS (MODERATE OR COMPLEX ONLY)

To adjust the angle of the shoulder wings, unzip the cover on both sides to access the adjustment bolt from above. Loosen the bolt **A**, and move the shoulder wing to the desired position. Tighten the bolt to secure in position and zip up the cover.



SECTION 18.17: ADJUSTING FOOTREST LENGTH

To adjust the footrest height, loosen the bolt **A**, and lengthen or shorten the height of the footrest to the desired position.

Tighten the bolt to secure in position. For the individual footrests the height can be adjusted independently. For the one-piece footrest the bolts need to loosen simultaneously to allow for adjustment.



SECTION 18.18: ADJUSTING FOOT STEM ANGLE (KNEE ANGLE)

To adjust the foot stem angle, loosen the bolt **A**, and rotate the foot stem to the desired position. Tighten the bolt to secure in position. For the two-piece footrests the angle can be adjusted independently. For the one-piece footrest the bolts need to loosen simultaneously to allow for adjustment.

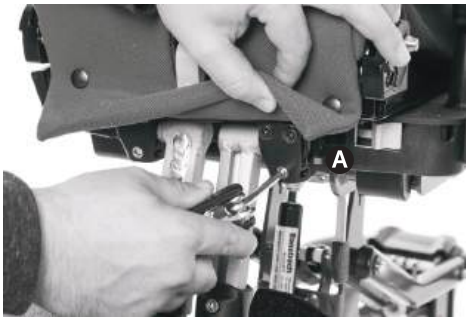

SECTION 18.19: ADJUSTING FOOTREST ANGLE (DORSIFLEXION AND PLANTARFLEXION)

To adjust the angle of the footrest to accommodate dorsiflexion and plantarflexion on the two-piece footplate, loosen or tighten the hand knob **A**, underneath the footplate to the desired position.



To adjust the angle of the footrest to accommodate dorsiflexion and plantarflexion on the one-piece footplate, loosen or tighten the bolt **B**, on the top surface of the footplate to the desired position.

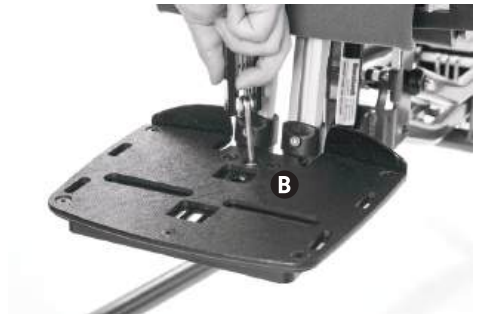

SECTION 18.20: ADJUSTING SANDALS

To position the user's feet in the sandals, secure the Velcro straps provided so the foot is held in place. The straps should be placed over the bridge of the foot **A**, and over the toes **B**. The front strap can be fed through one of two slots on either side of the sandals, depending on the size of the user's feet.

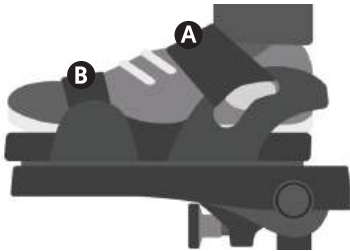

If the child is wearing sandals or light footwear check the straps to make sure the webbing does not irritate the skin.

To adjust the sandal position on the footplate, loosen the knob **C**, and move to the desired position. Tighten the knob to secure in place.

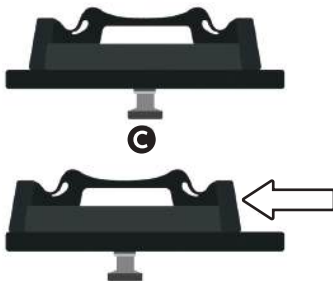

SECTION 18.21: ADJUSTING ANKLE HUGGERS

To adjust the ankle hugger, adjust the position of the Velcro strap around the ankle **A**, and the length of the strap through the triglide **B**.

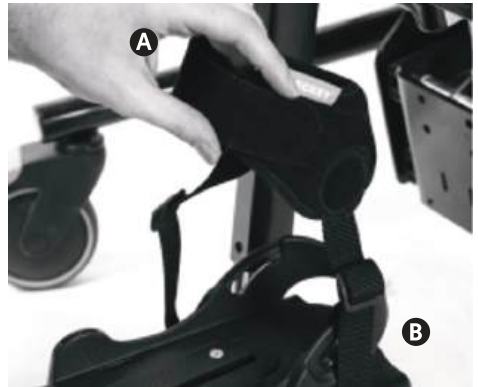

SECTION 18.22: ADJUSTING ANKLE WRAPS

To adjust the ankle wrap, adjust the position of the Velcro straps around the bridge of the foot **A** and around the ankle **B**.



SECTION 18.23: ADJUSTING BOOTIES

To adjust the booties, adjust the position of the Velcro strap around the bridge of the foot, **A**, the Velcro strap around the ankle **B**, and the length of the strap through the triglide **C**.

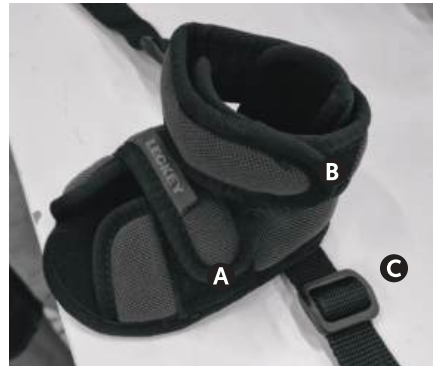

SECTION 18.24: ADJUSTING LATERALS (WIDTH, HEIGHT AND ANGLE)

To adjust the Lateral height, width and angle, loosen the bolt at the back of the basic backrest **A**, or at the back of the moderate and complex backrest **B**. Adjust the height, width and angle to the desired position and tighten to secure in place.

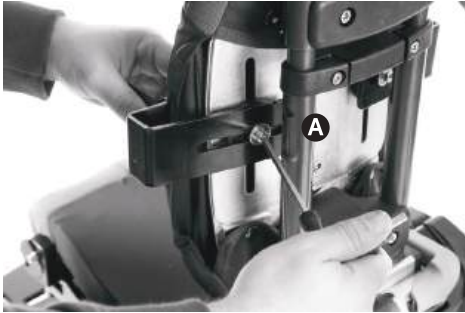

SECTION 18.25: ADJUSTING LATERALS (DEPTH)

To adjust the lateral depth, open the Velcro of the cover to gain access to the adjustment bolt **A**. Loosen the bolt and adjust forward or backward to the desired position. Tighten the bolt to secure in place. Reattach the Velcro cover.



SECTION 18.26: ADJUSTING FLEXIBLE WRAPAROUND HUGGING LATERALS

The hardware for the flexible laterals is adjusted in the same way as the Laterals. To adjust the tension in the flexible lateral, adjust the length of the webbing on the front lateral strap **A**.

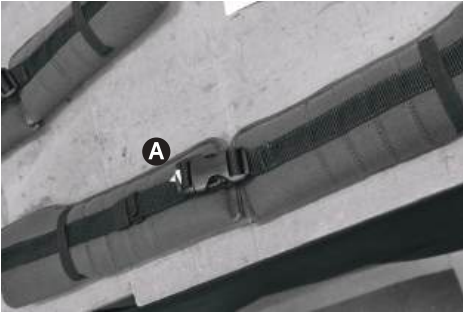

SECTION 18.27: ADJUSTING ARMREST HEIGHT

The armrest can be adjusted into several incremental height positions. To adjust the armrest height, loosen the bolt **A**, which rests off-centre from the midline of the plate. With the end of the tool still in the bolt head, slide the bolt across to the other side of midline, **B**, which will allow height adjustment of the armrest up and down. To secure, slide the bolt head back to the original off-centre position, **C**, into one of the several incremental height positions, and tighten the bolt to secure in place.

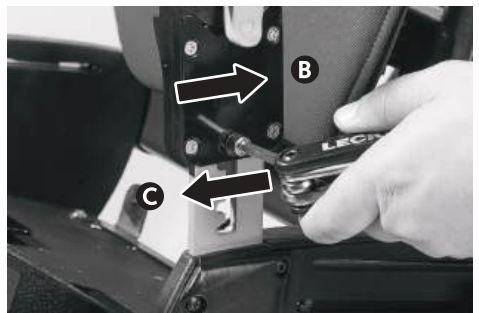
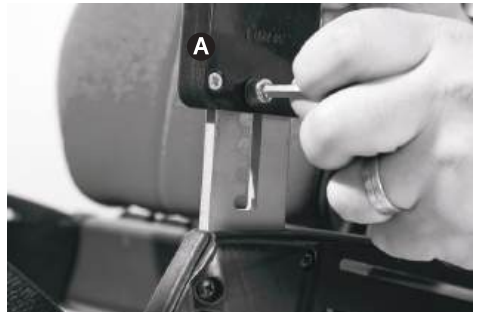

SECTION 18.28: ADJUSTING ARMREST ANGLE

To adjust the armrest angle, locate the cam lever **A**, in the centre of the armrest. Raise the cam lever to unlock and change the angle of the armrest **B**, to the desired position. Secure by lowering the cam lever to the locked position **C**.

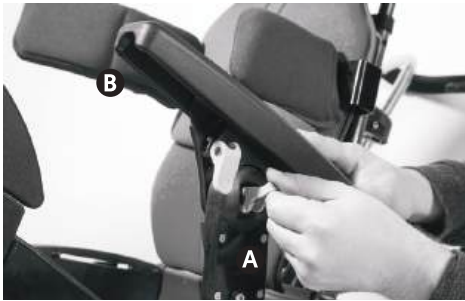

SECTION 18.29: ADJUSTING ARMREST DEPTH

To adjust the armrest depth, remove the bolts **A**, to separate the PU pad **B**, from the platework **C**. Reposition the pad in one of the three positions and insert the bolts. Tighten the bolts to secure in place.

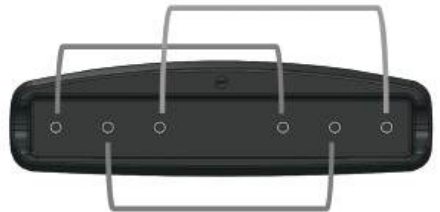
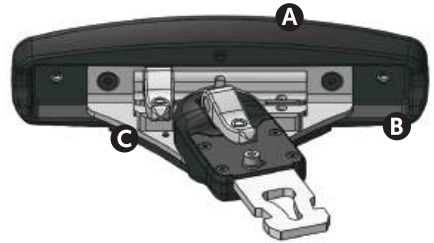

SECTION 18.30: ADJUSTING BUTTERFLY HARNESS

To adjust the butterfly harness, either change the amount of webbing passing through the cam buckles at the back of the seat base **A**, or top of the backrest **B**, or adjust the length of the webbing on the harness straps, in any of the four corners of the harness **C**.

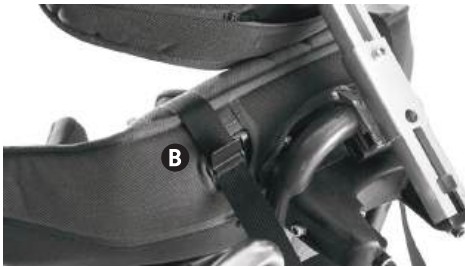
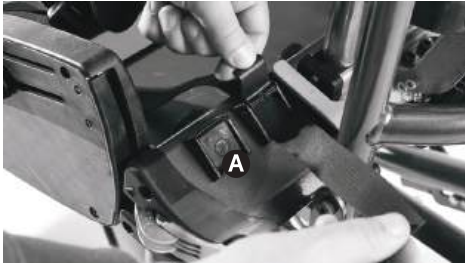

SECTION 18.31: ADJUSTING HEADREST

To adjust the headrest, loosen the bolts **A**, **B** & **C**. Adjust the headrest height, depth and angle into the desired position. Tighten the bolts **A**, **B** & **C**, to secure in place.



SECTION 18.32: ADJUSTING HEADREST LATERAL ANGLE

To adjust the angle of the headrest laterals, unzip the cover on both sides to access the adjustment bolt from above. Loosen the bolt **A**, and move the headrest lateral to the desired position. Tighten the bolt to secure in position and zip up the cover.



SECTION 18.33: ADJUSTING TRAY ANGLE

To adjust the tray angle, locate the cam lever, **A**, in the centre of the armrest. Raise the cam lever to unlock and change the angle of the armrest/tray **B**, to the desired position. Secure by lowering the cam lever to the locked position **C**.

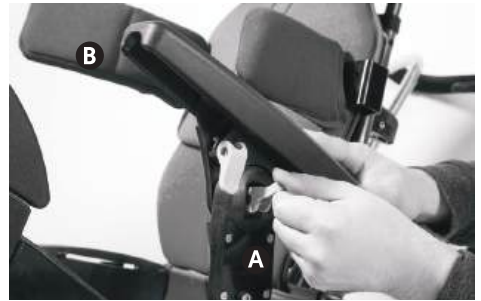

Always use caution to ensure the child's hands or arms do not become trapped when inserting the tray.

Never use the tray to steer or push the chair.

Do not place objects, hotter than 40 degrees Celsius (104 degrees Fahrenheit) on the tray.

Please note that the tray is for the use of the user only. Do not lean or place objects on the tray, greater than 8kgs (17.6lbs).

SECTION 18.34: ADJUSTING ELBOW BLOCKER POSITIONING

To adjust the elbow blocker, loosen the bolts, **A**, and slide the pad along the slots into the desired position. Tighten the bolts to secure in place.



SECTION 18.35: ATTACHING, DETACHING AND ADJUSTING 4-POINT BELT

To attach the 4-point belt, pass the grey webbing **through the upper slot** in the seat moulding **A**, and then through the cam buckle **B**. Pass the black webbing through the cam buckle at the front **C**. Pull the webbing taut and secure the cam buckles. Ensure belt is orientated with padding facing towards child.

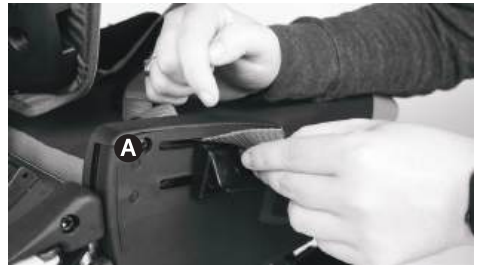

Attach the buckle **D**, at the front to secure the user.



 Always attached the pelvic strap first before making any other adjustments.

To detach the 4-point belt, reverse the process.

 **Safety Information:** You must ensure when using the 2-point belt that the webbing is fed through the slot in the seat core (not over the seat core). This is also recommended when using the 4-point belt.



SECTION 18.36: ATTACHING, DETACHING AND ADJUSTING 2-POINT BELT

To attach the 2-point belt, pass the grey webbing through the upper slot in the seat moulding **A**, and then through the cam buckle **B**. Pull the webbing taught and secure the cam buckles. Ensure belt is orientated with padding facing towards child.

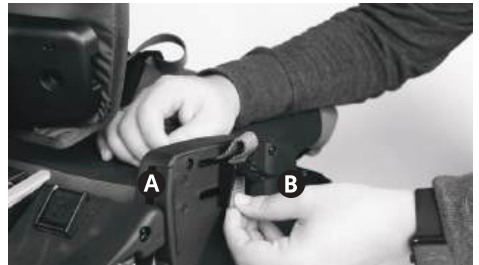

Attach the buckle **C**, at the front to secure the user.



 Always attached the pelvic strap first before making any other adjustments.

To detach the 2-point belt, reverse the process.



Safety Information: You must ensure when using the 2-point belt that the webbing is fed through the slot in the seat core (not over the seat core). This is also recommended when using the 4-point belt.



SECTION 18.37: ADJUSTING PELVIC CRADLE

To adjust the pelvic cradle, either change the amount of webbing passing through the cam buckles at the side of the seat base **A**, or back of the seat **B**. Or, adjust the length of the webbing on the front straps **C**, on either side.



SECTION 18.38: ADJUSTING FEMORAL GUIDES (WIDTH & ANGLE)

To adjust the width and angle of the femoral guides, lift the seat cushion up at the front, **A**, to gain access to the bolts **B**. On the basic seat there are femoral guides on the outside of the seat only. On the split seat that are four sets of femoral guides. Loosen the bolts and move to the desired position. Tighten to secure in place.

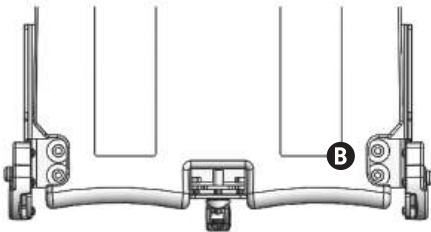

SECTION 18.39: ADJUSTING THE BACKREST ANGLE

The backrest angle can be adjusted in two ways: through the backrest recline mechanism and through the backrest interface at the base of the backrest.

To adjust the back angle through the backrest recline mechanism, locate the locking levers, **A**, at the rear of the seat. Simultaneously rotate both levers outwards **B**, to release the recline mechanism and move the backrest into the desired position. Return the levers to the closed position **A**, to secure in place.

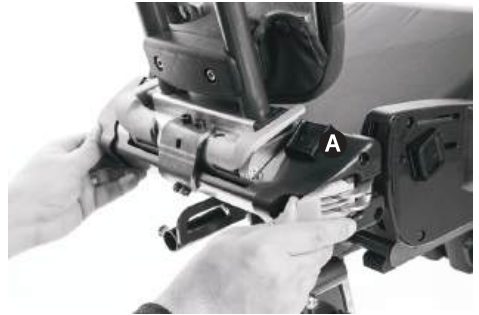

To adjust the back angle through the backrest interface at the base of the backrest, locate the bolt **D**, within the interface.

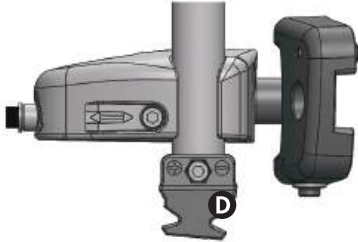



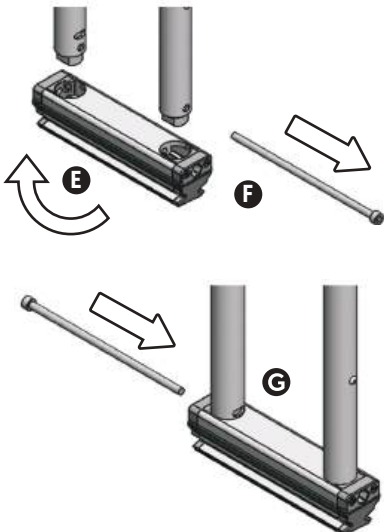

Completely remove the bolt from the assembly, separate the interface extrusion **E**, and end caps **F**, from the vertical tubes and rotate through 180 degrees. Slot the vertical tubes back into the interface extrusion and end caps **G**, and insert the bolt through all. Tighten the bolt with the nut to secure in place.

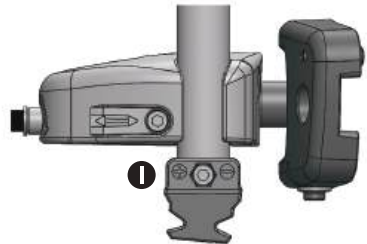

There are six positions of the backrest recline mechanism, in 5-degree increments, as indicated by the graphics **H**, on the side of the seat. Also two positions of the backrest interface, of 5-degree difference, as indicated by the graphics **I**, on the side of the interface end caps. Currently showing +10° to -15°.



The follow back angles can be achieved by the below combinations.

Backrest Recline Mechanism	Backrest Interface (symbol facing forward)	Seat to Back Angle (°)	Recline Range (°)
		90	0 -25
		90	+10 -15

SECTION 18.40: ADJUSTING DYNAMIC BACK STRENGTH

The resistance is adjusted by varying the air pressure and should be determined by the user's weight, seating position, seat design and personal preference.

The air pressure is adjusted with an air pump **A** (supplied with every dynamic back), on the main air valve of the dynamic mechanism **B**.



To increase the air pressure, pump air into the valve, to the desired pressure. To decrease the pressure, press the air release valve on the pump until the desired pressure is reached.



Warning: The pressure range is 50-250psi. Never exceed an air pressure of 250psi in the uncompressed shock system. Exceeding the maximum air pressure of 250lbs/inch could result in serious injury.

**USA Distributor**

Sunrise Medical (US) LLC
2842 N Business Park Avenue
Fresno, CA 93727

T: 1-800-333-4000
F: 1-800-300-7502
E: customseating@sunmed.com

sunrisemedical.com

Canadian Distributor

Sunrise Medical
237 Romina Drive, Unit 3,
Concord, ON, L4K 4V3

T: +1.800.263.3390
F: +1.800.561.5834
E: mkt.canada@sunmed.com

sunrisemedical.ca

Please visit leckey.com for a full list of Leckey distributors.

James Leckey Design Limited
19 Ballinderry Road
Lisburn, BT28 2SA
Northern Ireland

leckey.com

(+44) 28 9260 0750
hello@leckey.com

