



daytot neo⁺

USER MANUAL



Please read all instructions carefully before using the Daytot Neo+. All instructions can also be found on our website www.daytotjourneys.com along with videos, clinical case stories, and FAQs.

Contents

Section 1:	Intended Use	02
Section 2:	Certification	02
Section 3:	Warnings & Cautions	03
Section 4:	Terms of Warranty	06
Section 5:	Safety Information	06
Section 6:	Precautions & Contraindications	07
Section 7:	Cleaning & Care	08
Section 8:	Daily Inspection	09
Section 9:	Reissuing Daytot Products	09
Section 10:	Instructions for Use	10
	10.1 How to unpack and assemble Neo+	10
	10.2 Preparation and Set-Up	11
	10.3 Attaching the Covers	12
	10.4 Moulding the Neo+	13
	10.5 Using Neo+	19
	10.6 Maintenance and Repair	19
	10.7 Accessories	20
Section 11:	Technical Information	21
	11.1 Product Dimensions	21
	11.2 User Sizing	22
	11.3 Sizing Table	22
Section 12:	Table of Symbols	23
Section 13:	Frequently Asked Questions	24

SECTION 1: Intended Use

Daytot Neo+ is a multipurpose positioning support for babies aged 0-18 months showing atypical posturing due to surgery, disability, or delay. Designed with health care professionals, this lightweight, portable, and customisable support can be used for supervised lounging, playtime, and therapy. Intended for use up to 60 minutes per session.

Indications for use

Neo+ is indicated as a low assessment product available directly to parents or prescribed for use by the infants' therapist, paediatrician, or doctor. Users may include, but are not limited to infants displaying, Hypotonia, overuse of extensor patterning, poor central control, skeletal deformities (e.g., Scoliosis, or Plagiocephaly), or head turning preferences (e.g., Torticollis). These conditions typically affect an





infant's head control, posture, core strength and postural alignment when resting. Neo+ is intended to support the infant in a prone, supine, or side lying position. In these positions, the infant will be fully supported for activities that help develop head and trunk control, shoulder stability and overall symmetry of the body. Use of Neo+ for therapeutic outcomes would likely coincide with ongoing intervention from a variety of multidisciplinary teams to develop the infant's physical, cognitive, social, and sensory skills.

SECTION 2: Certification

Neo+ is a Class I Medical Device under EU and UK regulations. As the manufacturer, Daytot Ltd declares that this product conforms to the Medical Device Regulation (2017/745) and UK Medical Device Regulations 2002.

SECTION 3: Warnings & Cautions





Unpacking

	Do not leave plastic packaging in reach of children – Risk of suffocation. Store or dispose of appropriately.
	Do not leave small parts in reach of children – Choking Hazard. Store appropriately.
	Take care to read all instructional information fully before assembly or use. Digital copies of all information related to the product are available on the Daytot website.
	If in any doubt as to the correct operation of the product, please discontinue use and contact Daytot Customer Services at hi@daytotjourneys.com







Assembly

	Ensure all parts are assembled correctly as per <i>Section 10.1 'How to unpack and Assemble Neo+'.</i>
---	--



Setup For Use

	Product should only be used on a flat comfortable surface.
	Product should not be used on a surface that exceeds a 10-degree angle, unless advised by a practitioner.
	The product is to be checked daily to ensure that all components are securely attached and safe for use. <i>See Section 8 'Daily Inspection'.</i>
	Ensure the infant is always supported and positioned correctly in the product prior to use, as shown in <i>Section 10.5 'Using Neo+'.</i>

Operation

	Infants must always be supervised/monitored when using the product. Infants must not be left unattended at any time while using the product.
	Pay close attention to the infant's head and chin position. Ensure their airways are always clear.
	Do not lift the product up when the infant is in the product.
	Do not let the infant sleep in the product. Sleeping on their side / front can pose a suffocation risk and is thought to increase the risk of sudden infant death syndrome (SIDS). <i>Ref NHS Guidelines, the Lullaby Trust & US Safe to Sleep® Campaign.</i>
	Keep away from sharp objects. Risk of puncture.
	No other devices or products should be used in conjunction with Neo+.
	We recommend only using the pump provided with the product. Do not use electronic pumps with the product.

Cleaning & Storage

	Store out of reach of children.
	Do not store the product in direct sunlight or in extreme temperatures.

Disposal

	If disposing of the product, please follow the guidance of the local waste management facility. Constituent parts can be separated to aid recycling where possible.
---	---

SECTION 4: Terms of Warranty

A one-year warranty is provided on Daytot products. Life expectancy of the Neo+ is approx. three years. The life expectancy will vary depending on the frequency of use and number of washing cycles.

The warranty applies only when the product is used according to the specified conditions and for the intended purposes, following all manufacturers' recommendations.

SECTION 5: Safety Information

Notice to the user and/or operator: Any serious incident that has occurred in relation to the device should be reported to the manufacturer and the competent authority of the Member State in which the user and/or operator is established.

General

- Neo+ is compliant with flammability standard EN1021 Part 1 & 2. However, the product should be kept away from naked flames and all sources of ignition.

Assembly

- Do not modify or incorporate any components other than those supplied. Spare parts are available by contacting Daytot Customer Services at hi@daytotjourneys.com

Set-up for Use

- The product must always be used with the supplied cover. Spare covers are available to purchase on our website www.daytotjourneys.com.
 - (i) Wipe Clean covers are only available to be purchased, and used by, a medical professional.

Operation

- In the case of skin irritation or adverse reaction, remove the infant and notify Daytot Customer Services.
- Product is for indoor use only.

Cleaning & Storage

- Ensure regular cleaning of all parts as per *Section 7 'Cleaning & Care'*. Failure to follow these instructions could lead to accelerated wear, malfunction of the product or unwanted bacterial build-up.
- Always ensure that the product is fully cleaned before using it with different infants.
- Store in an appropriate place to stop trip or fall hazards and keep out of reach of children.
- Do not load product unnecessarily by storing it under other devices.
- We recommend using the Daytot bag for storing and transporting the product.

SECTION 6: Precautions & Contraindications

Neo+ can be used from 37 weeks gestational age (full term).

Neo+ can be used at home, in a hospital, early intervention, or clinical setting.

Precautions

- Medical instability including compromised respiratory or cardiovascular function.

Contraindications

There are no contraindications associated with the use of Neo+. All precautions are taken at the discretion of the prescribing clinician or parent. Daytot recommends that a trained and experienced clinician is present during initial assessments, set-ups and when the product is reissued, to minimise risk.

Therapists should use the precautions & contraindications list as a guide. Where the prescribing therapist feels that an infant is suitable, we ask that they do a risk assessment and proceed based on their clinical expertise.

SECTION 7: Cleaning & Care

- Sessional, daily, and weekly product cleaning is recommended.
- Disassemble the product into its various parts and follow the specific guidance for each part.
- Do not use bleach to clean the product or any of its parts.

Base Cushion, Valve & Pump

- Cushion can be cleaned using soap and warm water or wiped with a 70% Isopropyl alcohol solution.
- If required, the valve and cap can be disassembled and cleaned with soap and warm water or wiped with a 70% Isopropyl alcohol solution.
- If required, the pump can be cleaned with soap and warm water or wiped with a 70% Isopropyl alcohol solution.
- Ensure all components are fully dry before reassembly and use.
- Do not fully submerge the product or any of its parts in water.
- Do not machine wash.
- Do not use abrasive cleaning agents or appliances.

Upholstery

- Limit staining as quickly as possible with an absorbent cloth, towel, or sponge. Soap and warm water sponging are effective for ordinary soiling and minor spills. Be careful not to saturate the fabric as it could cause the stain to spread.
- All covers can be machine washed at 40°C. Make sure all upholstery items are fully dry before reassembling.
- Wipe clean covers can be wiped with a 70% Isopropyl alcohol solution.

SECTION 8: Daily Inspection

The following guidance should be followed before each session. If you have any doubt as to the safety of the product, stop using immediately and contact Daytot Customer Services at hi@daytotjourneys.com.

- Ensure all plastic parts are free from damage. Ensure all upholstery parts are free from damage. Check for tears, loose stitching, and excessive soiling. Check the pump and valve removes air from the product.

SECTION 9: Re-Issuing Daytot Products

Before re-issuing a Daytot product, we recommend that it is disinfected using the following procedure:

- Before re-issuing a Daytot product, the product should be inspected in accordance with *Section 8, 'Daily Inspection'* and cleaned thoroughly in accordance with *Section 7, 'Cleaning and Care'*.
- Ensure a copy of the user manual is supplied with the product. If in any doubt of the continued safe use of your Daytot product or if any parts should fail, please cease using the product and contact Daytot Customer Services.

SECTION 10: Instructions for Use

10.1: How to Unpack and Assemble Neo+

Take care not to cut through the box as you may damage some of the parts inside. Carefully remove everything from the box and check you have all the parts required.

Included:

- A. Base Cushion
- B. Cover Pack (x2)
- C. Pump
- D. Repair Kit
- E. Daytot Bag
- F. Instructions for Use.

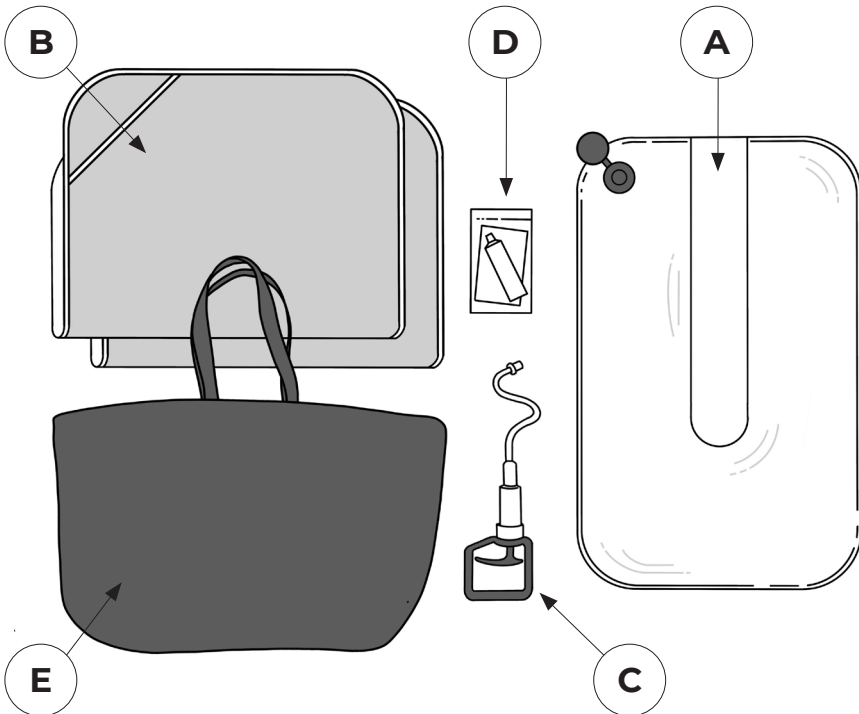

10.2: Preparation and Set-Up

10.2.1 Set the Neo+ on a flat comfortable surface (e.g., ward bed/cot, Daytot Activity Mat, carpeted flooring). Place the Neo+ base cushion so the valve is at the top left corner (when facing the product straight on) and the flat centre section is at the top.

10.2.2 Remove the cap from the valve.

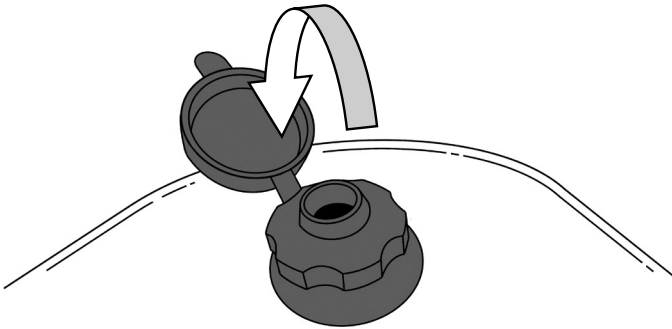

10.2.1

10.2.3 Open the valve by unscrewing it in a counter clockwise direction by approximately one full turn. This will allow the beads to move freely inside.

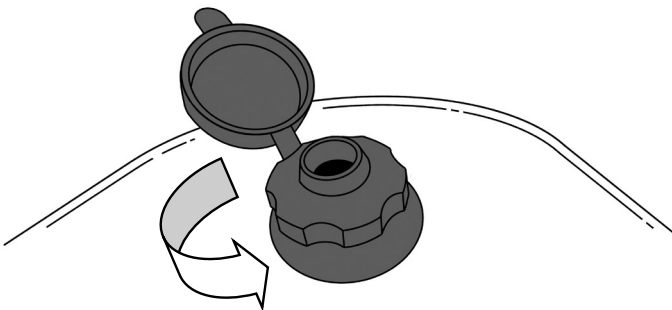

10.2.3

10.3: Attaching the Cover

The Neo+ cover has been designed with an envelope at the top. Slide the top of the Neo+ base cushion into the envelope (!).

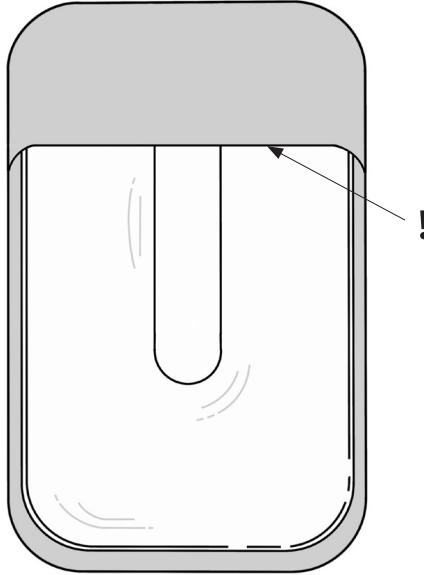

10.3

10.4: Moulding the Neo+

10.4.1 Locate the valve which is at the top left corner of the product. There is an opening in the cover to enable quick and easy access.

Close the valve by screwing it in a clockwise direction until tight.

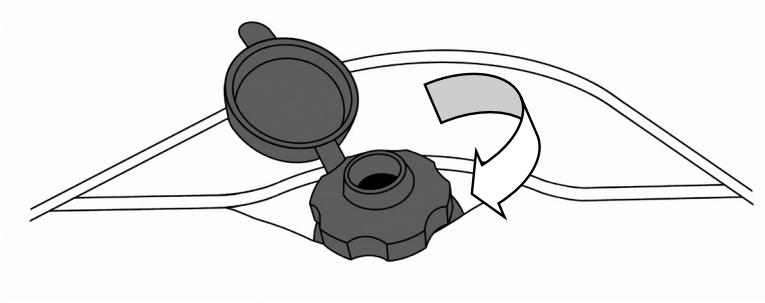

10.4.1

10.4.2 Attach the pump to the valve.

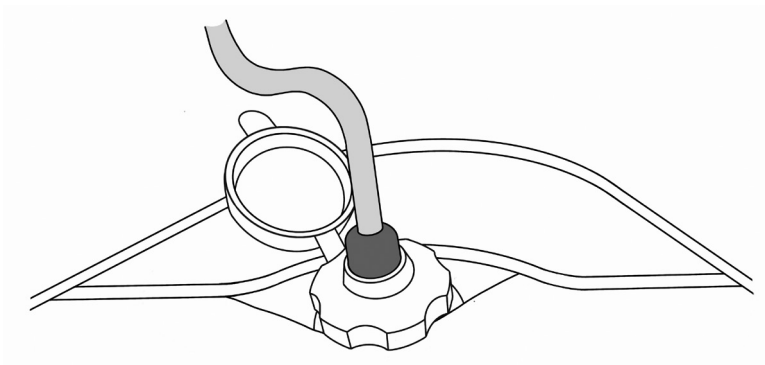

10.4.2

10.4.3 Fold the cover up to expose the base cushion.

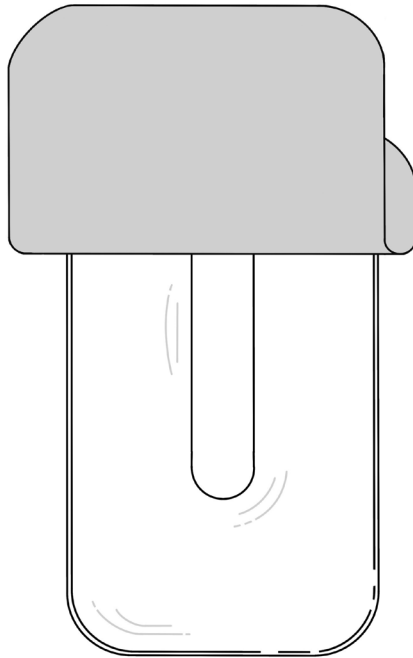

10.4.3

10.4.4 Use the pump to remove enough air from the base cushion so that it is mouldable.

10.4.5 Manipulate and tuck the Neo+ to achieve the desired shape. The edges can be rolled under to help reduce the overall size.

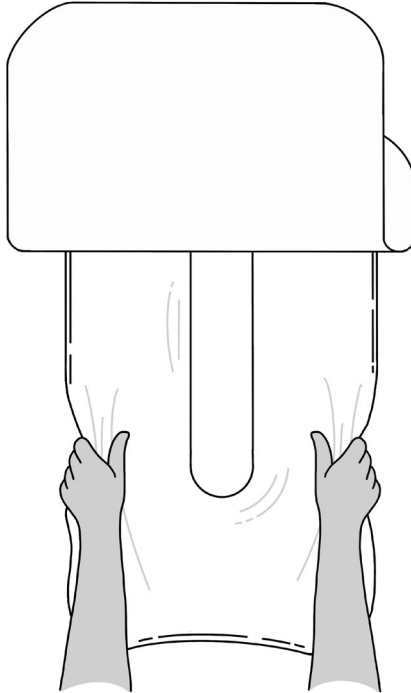

10.4.5

10.4.6 Place the infant on the Neo+ and adjust the shape to provide optimum support and positioning.

- **Supine (back lying)** – Position the infant in the centre of the Neo+ on their back with their bottom at the lowest point of the 'U'(!). Mould the base cushion to provide support down the infant's sides and under their legs.

NB. To keep the infant's airways clear, ensure there are no beads behind the head causing undesired neck flexion.

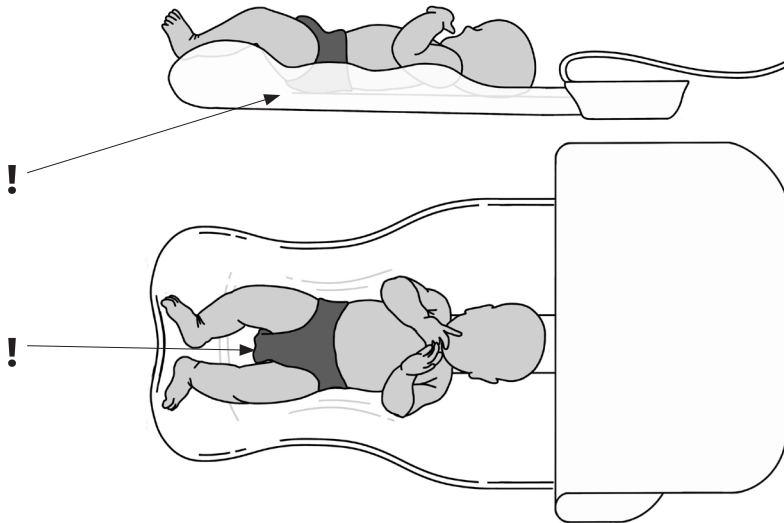

- **Prone (tummy lying)** – Position the infant at the bottom of the Neo+ on their front with their arms and head extending beyond the product. Mould the base cushion to provide support under the infant’s chest and down their sides.

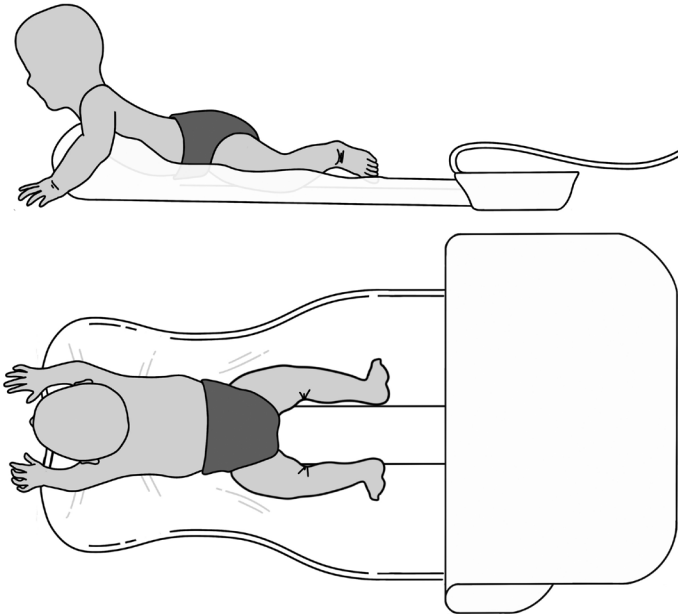

- **Side lying** – Position the infant in the centre of the Neo+ on their side with their bottom at the lowest point of the 'U'(!). Mould the base cushion to provide support along the infant's back and behind their legs.

NB. To keep the infant's airways clear, ensure there are no beads behind the head causing undesired neck flexion.

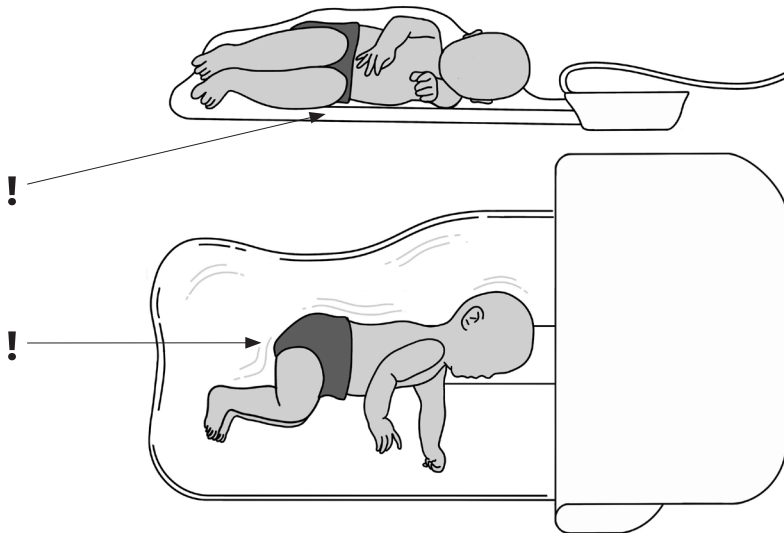

- 10.4.7 Once the required position has been achieved, use the pump to vacuum the base cushion to the desired level of firmness. The surface should be firm but comfortable for the infant.
- 10.4.8 Detach the pump and close the cap.
- 10.4.9 Remove the infant and fold the cover back down over the base cushion.
- 10.4.10 Place the infant back onto the product.

Before each session, the pump should be used to vacuum the base cushion to the desired level of firmness.

10.5: Using Neo+

To help you get the most out of your Daytot Neo+ we have created a Therapy Guide, providing education and support to users. The Neo+ Therapy Guide will cover the fundamental principles of good postural positioning for infants, as well as offering advice on how to place infants in three fundamental positions with suggested activity options –

- *Prone (back lying)*
- *Supine (tummy lying)*
- *Side Lying*

The Therapy Guide is available to download for free on the Daytot website – www.daytotjourneys.com/daytot-neo

If in any doubt as to the correct use of the product, or suitability, please consult with your therapist, or contact Daytot Customer Service at hi@daytotjourneys.com for advice.

10.6 Maintenance and Repair

If the Neo+ is not holding shape, inspect the product for damage. Ensure the valve is free from damage and can be tightened correctly. Ensure the base cushion is free from damage and punctures. Ensure the pump is drawing air from the base cushion.

To test for leaks, use the pump to vacuum the base cushion firm. Wipe the base cushion with soapy water. Look for small bubbles or listen for a 'hissing' sound to locate the damaged area.

If you identify a leak, this can be mended using the repair kit provided. Using the PVC swatch from the repair kit, cut a patch to cover the affected area of the base cushion. Clean and dry the surfaces of the base cushion and the patch. Apply an even layer of adhesive to both surfaces and leave to dry completely. Apply another layer of adhesive to both surfaces and leave to dry for 10 minutes. Position the patch over the affected area and apply pressure until the patch is securely in place. Leave to fully set for 24 hours.

10.7: Additional Accessories

As well as the accessories listed at the start of section 10, the following accessories are also available to purchase from the Daytot website at www.daytotjourneys.com.

- *Fabric Cover Set*
- *Wipe Clean Cover Set *Wipe Clean cover only available to medical professionals*
- *Pump*
- *Base Cushion*
- *Puncture Repair Kit*
- *Daytot Bag*
- *Daytot Activity Mat*

SECTION 11: Technical Information

11.1: *Product Dimensions*

BASE CUSHION	
Width	60cm / 23.5"
Length	85cm / 33.5"
Weight	625g / 1.4lbs
COVER	
Width	65cm / 25.5"
Length	95cm / 37.5"
Weight	400g / 0.9lbs
PUMP	
Width	10cm / 4"
Length	22cm / 8.5"
Depth	5cm / 2"
Weight	150g / 0.3lbs



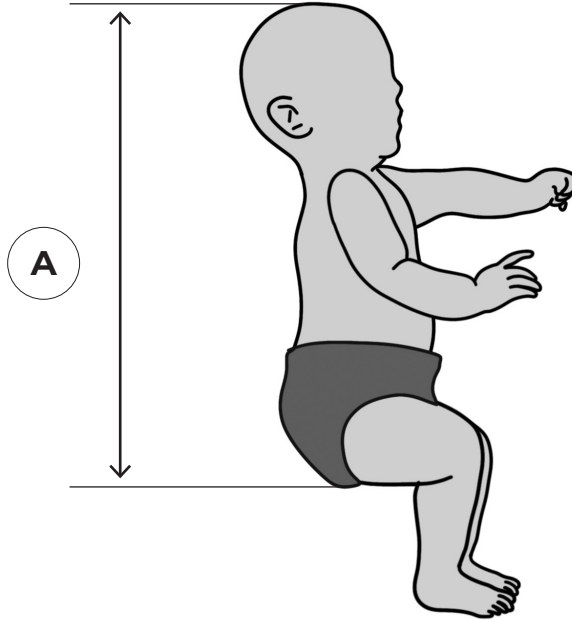













11.2: User Sizing – Key Dimensions to Measure



11.3: Neo+ Sizing Table

Age	0-18 months
User Weight	Max 15kg / 33lbs
(A) Top of head to Bottom	Max 55cm / 21.7"

SECTION 12: Table of Symbols

Symbol	Meaning
	Medical Device
	Read the Instructions for Use
	CE Mark
	Warning
	Caution
	Manufacturer
	Product Code
	Serial Number
	Max Occupancy Weight
	Date of Manufacture
	Unique Device Identification
	Machine Wash – water temperature 40°C
	DO NOT Tumble Dry
	DO NOT Iron
	DO NOT Bleach
	DO NOT Dry-Clean

SECTION 13: Frequently Asked Questions

Why is Neo+ different to other support / positioning systems?

The Neo+ supports posture whilst the infant is awake and moving, actively strengthening the whole child and is different therefore from more traditional positioning which may be more passive or used when the child is asleep.

The contouring the product provides ensures it is adaptable and individualised to suit each child. The level of support that may be offered can influence the whole of the infant including the pelvic position which is key supporting the core.

How do I know if Neo+ is suitable for my child?

The Neo+ is a positioner for infants ages 0-18 months who have delay in their development and require supportive positioning to strengthen their core, improve their patterns of movement +/- assist access to their environment.

My child has quite high / low tone. Can they use Neo+?

The Neo+ provides a supported flexed resting position for your child from which to move. For the child with high tone, it inhibits asymmetrical and more extended postures allowing for a better quality of limb movement. The lower toned child benefits from the central support given to reduce effort required for movement. In both cases the Neo+ promotes central core strength, symmetry, and development.

My child doesn't like certain positions – what should I do?

It is not uncommon for infants to show preferences for certain positions but for developmental progression, unless advised otherwise, placing your child in different positions is encouraged. Due to the support provided you may find that previous challenges are easier. It may be appropriate to work in one position first to improve your child's core strength and posture progressing to a more varied selection later. Talk to your child's therapist if you have any concerns.

Is Neo+ suitable for infants with controlled / uncontrolled seizure activity?

It is important that all infants are supervised when using this product. If a seizure occurs whilst in the Neo+ the positioner can be softened if required by opening the valve, we recommend you follow your normal seizure management protocol for your child.

Can I over/under vacuum the Neo+?

Yes. If you do not take sufficient air out of the product it will not retain its shape to support your child. The product should feel firm but have some bead movement when handled to ensure that it is not a rigid surface.

Can Neo+ be used for sleeping?

Neo+ is not recommended for sleep. Do not let the infant sleep in the product. Sleeping on their side / front can pose a suffocation risk and is thought to increase the risk of sudden infant death syndrome (SIDS). *Ref NHS Guidelines, the Lullaby Trust & US Safe to Sleep® Campaign.*