



R-series

DR50 and DR90

Scooter Controllers



Installation Manual

About this Manual

This manual can help you understand and install the Dynamic Controls (DYNAMIC) R-SERIES scooter controller. It describes the general principles, but it gives no guidelines for specific applications. If there is a specific requirement for your application, please contact Dynamic Controls or one of the sales and service agents to assist you.

This manual must be read together with all other relevant scooter component manuals.

In this manual, a few symbols will help you identify the purpose of the paragraph that follows:

	Notes & Precautions:
	Notes provide supporting information in order to install, configure, and use the product. Not following the instructions given in notes or precautions can lead to equipment failure.
	Warnings:
	Warnings provide important information that must be followed in order to install, configure, and use the product safely and efficiently. Not following the instructions given in a warning can potentially lead to equipment failure, damage to surrounding property, injury or death.

The term '**programming**' used in this manual refers to adjusting parameters and configuring options to suit an application. 'Programming' does not change or alter any software within the controller and is performed using a controlled programming tool available only to authorised personnel.

The product is not user serviceable. Specialised tools are necessary for the repair of any component.

Do not install, maintain or operate this equipment without reading, understanding and following this manual – including the Safety and Misuse Warnings – otherwise injury or damage may result. This manual contains integration, set-up, operating environment, test and maintenance information needed in order to ensure reliable and safe use of the product.

Due to continuous product improvement, DYNAMIC reserves the right to update this manual. This manual supersedes all previous issues, which must no longer be used.

DYNAMIC reserves the right to change the product without notification.

Any attempt to gain access to or in any way abuse the electronic components and associated assemblies that make up the scooter system renders the manufacturer's warranty void and the manufacturer free from liability.

DYNAMIC, the DYNAMIC logo, the Rhino logo and the R-series logo are trademarks of Dynamic Controls. All other brand and product names, fonts, and company names and logos are trademarks or registered trademarks of their respective companies.

DYNAMIC owns and will retain all trademark rights and DYNAMIC or its licensors own and will retain all copyright, trade secret and other proprietary rights, in and to the documentation.

All materials contained within this manual, in hardcopy or electronic format, are protected by copyright laws and other intellectual property laws.

© Copyright 2016 Dynamic Controls. All rights reserved.

Contents

1	Introduction to the R-series	7
2	Specifications	8
2.1	Electrical Specifications	8
2.2	Physical Specification	9
3	Installation and Testing	10
3.1	Mounting	10
3.2	Connections and Wiring	11
3.2.1	Typical R-series Wiring Installation	11
3.2.2	General Wiring Recommendations	12
3.2.3	Battery Connections	13
3.3	Motor Connections	14
3.3.1	Motor Protection	14
3.3.2	Motor Testing	15
3.4	Park Brake Connections	16
3.4.1	Park Brake Testing	17
3.5	Battery Charging and Programming Connections	18
3.5.1	Battery charger connections	18
3.5.2	Programmer Connections	20
3.6	Tiller Connector	21
3.7	Throttle Configuration	23
3.7.1	EN12184 and ISO7176 requirements	23
3.7.2	Single throttle wiper	24
3.7.2.1	Additional hardware to comply with ISO7176-14	24
3.7.3	Neutral Detect	25
3.7.3.1	Installation of a Neutral Detect switch	26
3.7.4	Two throttle wipers - mirrored	27
3.7.5	Throttle Calibration	29
3.7.6	Speed Limit Pot Connections	30
3.7.6.1	In series with the throttle wiper	30
3.7.6.2	In parallel with the throttle	31
3.7.7	Alternative Speed Reduction Options	32
3.7.8	Tiller Battery Supply	33
3.7.9	Key Switch Input	34
3.7.10	Status Indicator Output	34
3.7.11	Beeper Output	35
3.7.12	Battery Gauge Output	35
3.7.13	Brake and Reversing Lights	36
3.8	Multi-function Pins	37
3.8.1	Multi-function Inputs	37
3.8.1.1	Active States	39
3.8.1.2	Slows to	40
3.8.1.3	Latches	40
3.8.1.4	Flashes	40

3.8.2	Multi-function Outputs	41
3.9	Testing.....	42
4	Programming the R-series.....	43
4.1	The Hand Held Programmer (HHP)	44
4.1.1	Programming menu	45
4.1.1.1	Profile 1/2	45
4.1.1.2	Non-profiled	46
4.1.1.3	Throttle calibration	47
4.1.2	Diagnostics menu	49
4.1.3	Technician menu	50
4.2	Dynamic Wizard.....	51
4.2.1	Software revisions	51
4.3	Parameter List.....	52
4.4	Parameter Descriptions	56
4.4.1	User Personalisation	56
4.4.1.1	Sleep Timer.....	56
4.4.1.2	Wakeup Style	56
4.4.1.3	Swap Throttle Direction	57
4.4.1.4	Enable Beeper	57
4.4.1.5	Flash Code Beeper	57
4.4.1.6	Sleep Beeper.....	57
4.4.1.7	Reverse Beeper.....	58
4.4.1.8	Motion Beeper	58
4.4.1.9	Beeper Timing	58
4.4.1.10	Deep Discharge Beeper	59
4.4.1.11	Sleep on Fault or Inhibit.....	59
4.4.1.12	Power Off after Sleep	59
4.4.2	Throttle Configuration	60
4.4.2.1	Throttle Type	60
4.4.2.2	Throttle Input.....	60
4.4.2.3	Throttle Neutral Offset.....	61
4.4.2.4	Throttle Full Scale Deflection	61
4.4.2.5	Throttle Response	62
4.4.2.6	Throttle Dead-band	62
4.4.2.7	Throttle Testing	63
4.4.2.8	Maximum Throttle Voltage	63
4.4.2.9	Throttle OONAPU Testing.....	64
4.4.2.10	Throttle Fault Non Latching	64
4.4.2.11	Speed Limit Pot	65
4.4.2.12	Slam Brake	66
4.4.2.13	Broken Wiper Wire Detection.....	67
4.4.3	Drive Performance	67
4.4.3.1	Maximum Forward Speed	67
4.4.3.2	Forward Acceleration	67
4.4.3.3	Forward Deceleration	69
4.4.3.4	Maximum Reverse Speed.....	70
4.4.3.5	Reverse Acceleration	70
4.4.3.6	Reverse Deceleration.....	71
4.4.3.7	Lowest Forward Speed.....	72
4.4.3.8	Lowest Reverse Speed	72
4.4.3.9	Soft Start Period	73
4.4.3.10	Soft Finish.....	73
4.4.3.11	Emergency Deceleration	74

4.4.3.12	Slam Braking	74
4.4.3.13	Push Speed	75
4.4.3.14	Roll-away Speed	75
4.4.3.15	Speed Reduction Wiper (SRW) parameters	76
4.4.4	OEM Drive Limits	77
4.4.4.1	Maximum Forward Speed Limit	77
4.4.4.2	Maximum Reverse Speed Limit	77
4.4.4.3	Lowest Forward Speed Limit	77
4.4.4.4	Lowest Reverse Speed Limit	77
4.4.4.5	Acceleration Limit	77
4.4.4.6	Deceleration Limit	77
4.4.5	Motor Management	78
4.4.5.1	Motor Protection	78
4.4.5.2	Motor Protection Parameters (Rev. C,D and E)	78
4.4.5.3	Motor Protection Parameters (Rev. A and B)	79
4.4.5.4	Motor Reverse	79
4.4.5.5	Load Compensation	80
4.4.5.6	Maximum Load Compensation	81
4.4.5.7	Load Compensation Damping	82
4.4.5.8	Remembered Load Compensation	82
4.4.5.9	Current Limit	83
4.4.5.10	Boost Current / Boost Time	83
4.4.5.11	Stall Timeout	84
4.4.5.12	Motor Testing	85
4.4.5.13	Maximum Motor Voltage	85
4.4.5.14	Dead-time Adjust	85
4.4.6	Park brake Management	87
4.4.6.1	Park brake Testing	87
4.4.6.2	Park brake Neutral Delay	87
4.4.6.3	Park Brake Release Delay	88
4.4.7	Battery Management	88
4.4.7.1	Overvoltage Rollback	88
4.4.7.2	Undervoltage Rollback	88
4.4.7.3	Battery Gauge Minimum/Maximum	90
4.4.7.4	Battery Gauge Warning	90
4.4.7.5	Battery Cut-Off Voltage	90
4.4.7.6	Battery Gauge Dead-band	91
4.4.7.7	Battery Gauge Sensitivity	91
4.4.8	System Options	92
4.4.8.1	Service Scheduler	92
4.4.9	Multi-function Inputs Configuration	93
4.4.9.1	Pin [X] Function	93
4.4.9.2	Active States	96
4.4.10	Multi-function Outputs Configuration	97
4.4.10.1	Flash Code Type	97
4.4.10.2	Pin 3/11 Function	98
4.4.10.3	Pin 10 Function	99
4.4.10.4	Key Switch Status LED	99
5	Diagnostics	100
5.1	Introduction	100
5.2	Flash Code Display	100
5.2.1	Scooter Flash Codes	101
5.2.2	SHARK Flash Codes	102

5.2.3	Type 3 Flash Codes.....	103
5.2.4	Type 4 Flash Codes.....	103
5.3	Diagnostics Tools.....	104
5.4	HHP Fault Codes with Sub Codes	105
5.5	Advanced Diagnostics Logs	107
5.6	Service Scheduler	108
6	Appendices	109
6.1	Neutral Detect Active States	109
6.2	Parts List	110
6.3	Intended Use and Regulatory Statement.....	111
6.4	Service life	111
6.5	Maintenance	112
6.6	Warranty.....	112
6.7	Safety and Misuse Warnings	113
6.8	Electromagnetic Compatibility (EMC)	115
6.9	Environmental statement	116

1 Introduction to the R-series

The R-series family of scooter controllers provides a reliable, refined, cost-effective control solution for most mobility scooters and includes:

- DR50-A01 - R-series 50 A Controller
- DR50-B01 - R-series 50 A Controller compatible with separate metal top cover
- DR90-A01 - R-series 90 A Controller



DR50



DR90

- 50 and 90 A models provide the power you want when you need it
- Programmable acceleration curves, zero rollback on slopes, improved motor matching algorithms ensuring improved curb-climbing and hill-starting capabilities
- Speed reduction wiper (SRW) technology provides seamless speed reduction in curves for extra stability.
- Intelligent motor and battery management providing automatic power flow optimisation, auto battery configuration, 5V and 12V battery capacity outputs and in-depth battery logging and analysis tools.
- Drop-in replacement with industry standard connections and mounting, support for a range of battery types, multifunction pins and flexible drive inhibits
- Advanced diagnostics and servicing tools, including event and drive time logging, and programmable servicing scheduler.
- 2 drive profiles, brake and reverse lights, reversing beeper and electronic park brake release.
- A separately available metal top cover for the DR50-B01 and DR90-A01 variants provides maximum protection against water splashes and overheating.
- Throttle Dual Decode provides extra safety in case of a throttle failure, and allows OEMs to comply with the requirements of ISO7176-14: 2008.
- Deep Discharge Beeper provides an audible alarm for when the battery is drained below the battery's cut-off level to comply with the requirements of ISO7176-14: 2008.
- RSeries controllers comply with global standards, and are intended for use with Class B scooters, as defined in EN12184:2014 E.



Note:

Unless otherwise specified, all references in this manual apply to all variants of the R-series controller.

2 Specifications

2.1 Electrical Specifications

Parameter	Description			
Compatible Battery Supply	24V supply, 2 x 12V in series, circuit breaker protected. For the DR50, recommended minimum capacity 15 Ah. For the DR90, recommended minimum capacity 20 Ah.			
Compatible Motor	24V DC permanent magnet type, typically rated 100-300 watts.			
	Min	Nominal	Max	Units
Operating Voltage (V_{batt})	18	24	32	V
Reverse Supply Voltage	-32			V
Quiescent Current (idle)		0.3		mA
Charging Current		8		A (RMS)
Throttle Resistance (Pin 2 to Pin 8)	4	5	6	k Ω
Speed Limit Pot – Pin 9 (linear)	90	100	110	k Ω
Speed Reduction Wiper – Pin 4 (log)	9	10	11	k Ω
Current Rating – DR50				
• Continuous (@ 20°C ambient)		14		A
• Peak (<60 seconds @ 20°C initial)		40		A
• Boost Current		10		A
• Boosted Current		50		A
• Boost Time	0		8	s
Current Rating – DR90				
• Continuous (@ 20°C ambient)		20		A
• Peak (<60 seconds @ 20°C initial)		70		A
• Boost Current		20		A
• Boosted Current		90		A
• Boost Time	0		8	s
Park Brake Output				
• Voltage		24		V
• Current	1.25			A

2.2 Physical Specification

Parameter				
Material	Die cast Aluminium base with Plastic Cover			
- Aluminium Base	Aluminium alloy ADC12			
- Plastic Cover	Kingfa JH960 6300 - UL94 V-0 rating			
Protection Rating	Electronics rated to IPx5			
Shipping Weight	260 grams			
	Min	Nominal	Max	Units
Operating Temperature Range	-25 -13		50 122	°C °F
Storage Temperature Range	-40 -40		65 150	°C °F
Operating Humidity Range	0		90	%RH

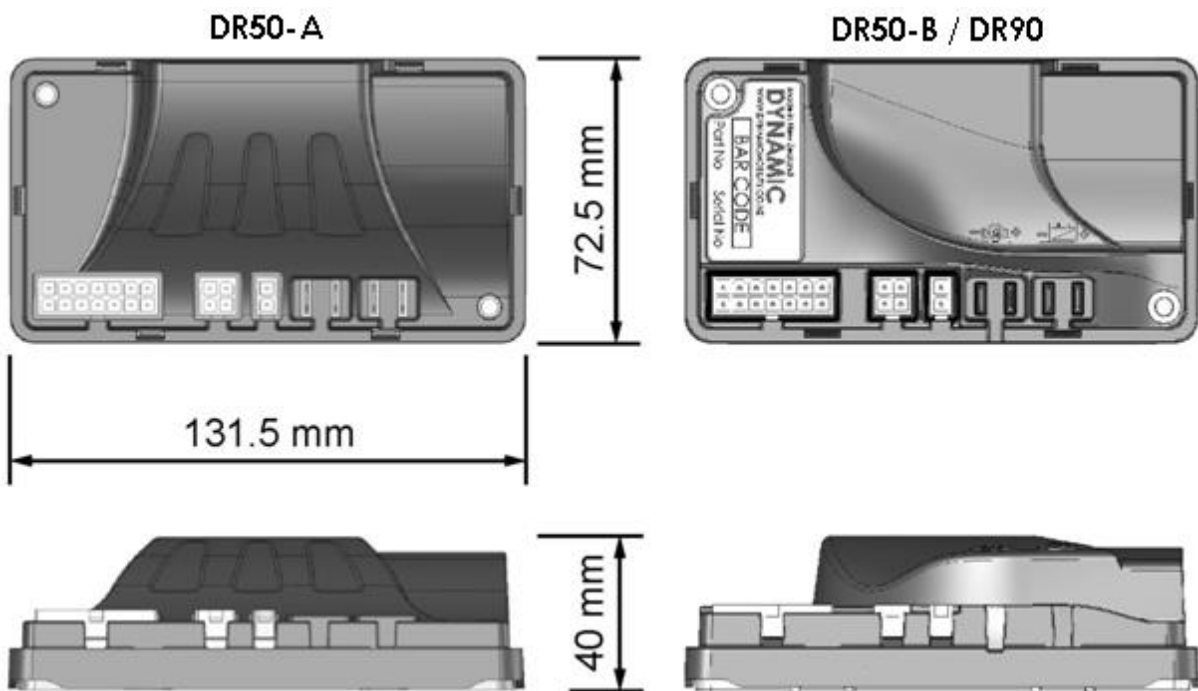

For mounting hole dimensions, refer to Section 3.1

3 Installation and Testing

3.1 Mounting

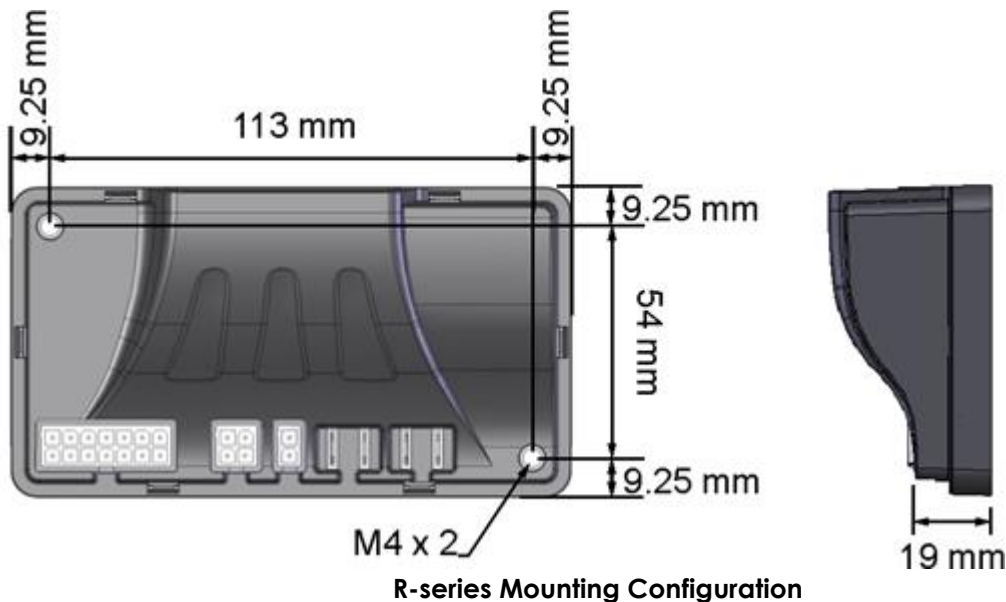

- The position and orientation should give maximum mechanical protection to the controller.
- Mount out of the path of water splashes from wheels or cowling and protect the connector panel from direct splashing.
- The controller can be mounted horizontally or vertically, if vertically position the connectors on the bottom.
- As drain holes are incorporated within the connector panel, mounting on an inclined plane with the connectors at the bottom would facilitate drainage.
- The controller must be mounted so that water will drain away from the controller.
- Failure to adhere to the mounting conditions specified may lead to water ingress, which could result in system malfunctions and long-term damage to the unit.
- For peak performance, locate the controller so that air can flow over and around the case, particularly if mounting in the tiller.
- If the controller is mounted in a tray or cavity, ensure that there are adequate drainage holes to prevent the accumulation of liquids around the controller.
- A position close to the batteries and motor is recommended to reduce the length of high-current wires.
- Use both screw positions to attach the controller. Socket cap screws are recommended. Select a screw length that protrudes between 4 and 6mm through the case. Do not over tighten the mounting screws.



Regardless of mounting orientation, protect scooter wiring, connectors and components (including those of the tiller head) from the risk of damage, water splashes and/or water ingress, and route the cabling so that water will not run down into the connector system. The use of cable boots is highly recommended.

Do not mount the R-series in a position where the user can come into contact with the unit. The case temperature can exceed 41°C.

If the controller is mounted in a tray, ensure that there are adequate drainage holes in the tray to prevent the accumulation of liquids around the controller.

3.2 Connections and Wiring

3.2.1 Typical R-series Wiring Installation

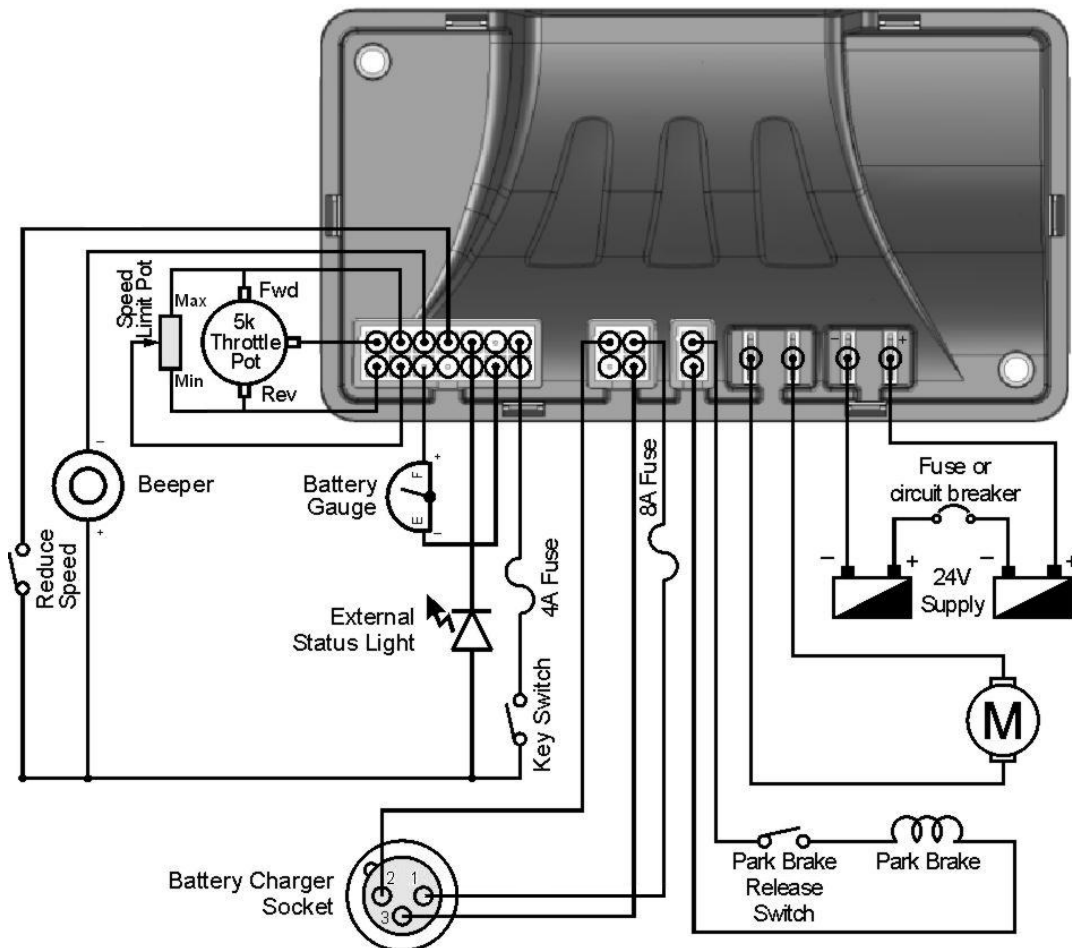

Note:

To meet the requirements of relevant standards, a status indicator must be fitted to the scooter.



Warning:

It is the responsibility of the installer to make sure that the finished wiring package is safe and fit for purpose.

Before making any connections to the controller, disable the scooter by one of the following means to prevent accidental movement.

- Place the battery circuit breaker in the open position.
- Disconnect the motor or batteries and/or elevate the drive wheels.

To meet ISO requirements, the Battery and Motor connectors must be fixed in such a way they cannot be swapped or transposed. Alternatively, these may be protected by a cover that cannot be removed without the use of tools.

Incorrect battery connection may lead to immediate controller damage and risk of fire. (This can occur, for example, if a battery lead is connected to a motor terminal.)

3.2.2 General Wiring Recommendations

To maximise performance, minimise EMC emissions, maximise EMC and ESD immunity, and to keep the cabling of the scooter safe and tidy, please observe the following guidelines.

- Keep all cables as short as possible.
- Avoid wire loops, especially loops of single wires instead of wire pairs. Try to run wires in pairs or bunches. Bind wires together and fix them to the chassis.
- Do not route the cables (including the motor cable) near the motor case, where possible.
- Do not leave electrical connections unnecessarily exposed. Insulate exposed connections (for example with sleeving) to reduce the risk of short circuits, exposure to water and connection stress.
- Make sure that all vehicle sub-frames, particularly the transaxle, controller case and tiller head assemblies, are electrically connected.
- Make sure that the controller and speed setting potentiometers are electrically connected to the vehicle frame.
- Do not use the vehicle frame as the earth return. Any electrical low-resistance connection to the frame is a safety risk and is not allowed by international safety standards.
- To minimise electromagnetic emissions by the motor brushes, it may be necessary to fit capacitors between the brush holders and the motor case. Make sure that the leads are kept as short as possible. A suitable capacitor is 4n7, 2kV Ceramic.
- For best electrical performance, the wire size must be as large as possible. Recommended minimum wire sizes are shown in the wiring sections.
- For low-current signals, do not use wire sizes smaller than 0.5 mm²/AWG20, because smaller wires are physically not strong enough for this application.
- The type of cable used must be appropriate for the mechanical and environmental abuse it is likely to encounter.
- Do not use damaged or abused cables. A damaged cable can potentially produce localised heat, sparks or arcing and as such it can cause a fire.
- Protect all cables against possible contact with flammable material.
- Where possible, the installation must prevent and/or discourage the user to access any cable.



Warning:

1. Route the cables and fasten all scooter components in a position so that the cables, the connectors and the connector sockets of the R-series do not allow water entry or suffer from physical strain, abuse or damage, such as cutting or crushing. Take particular care on scooters with movable structures such as seat raise. Make sure that the cables do not extend from the scooter so that they cannot be caught or damaged by external objects.
2. Disconnect all the cables of the scooter at the powered end whenever units are replaced or moved.
3. The user maintenance schedule and the service instructions of the scooter must include the appropriate inspection and maintenance requirements for the connectors and the cables.

3.2.3 Battery Connections

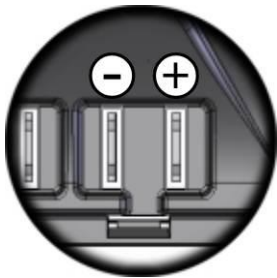
Battery Connections			
	Pin	Function	Minimum Wire Gauge (see notes below)
	+	Battery Positive	R50 : 2.5mm ² 13 AWG
	-	Battery Negative	R90 : 4.0mm ² 11 AWG
Mating Connector			
Industry standard ¼" (6.35mm) Quick Connect ("QC") female receptacles, available from many manufacturers. Use only high quality parts from a reputable manufacturer.			

The wire gauge recommendations above are the MINIMUM gauge and are generally suitable for runs up to 800 mm. Longer runs will require heavier wire – typically an extra 1.0 mm² for each additional 400 mm run length. The heavier the wire, the better driving performance will be. These notes are in addition to the General Wiring Recommendations as described in Section 3.2.2.



Note:

The final connection to the Battery Positive (+) terminal should not be made until the scooter is completely wired and ready for testing as described in the Testing section.

The R-series has been designed to perform optimally with multiple battery types (see below). By default Lead-Acid and Gel Cell 24 V deep cycle batteries rated between 20 - 120 Ah are to be used.

To comply with ISO requirements, a red wire for the Battery Positive must be used. This must be the only use of a red wire in the controller installation.



Warning:

A thermal circuit breaker or fuse must be installed between the battery supply and the controller, to protect both the batteries and the system wiring. This shall be mounted as close as possible to the batteries. The thermal circuit breaker should have a trip rating no higher than the current limit of the controller. Check thoroughly to ensure that it provides the necessary degree of motor protection.

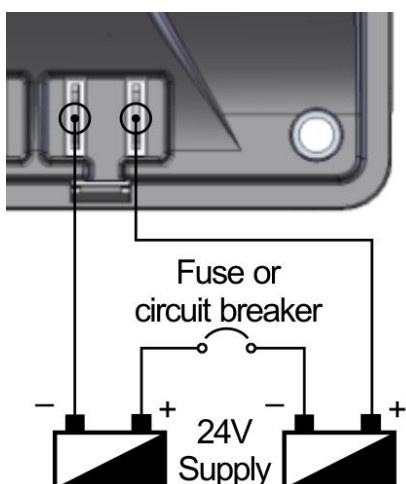

Model	Fuse or circuit breaker rating.
R50	30 – 40 A
R90	40 – 50 A

If the two batteries are permanently wired together (for example in a single battery box), the best position for the circuit breaker is between the two batteries. If the batteries are separated (individual battery boxes), each battery requires a circuit breaker. A slow-acting, thermal type circuit breaker is suggested.

3.3 Motor Connections

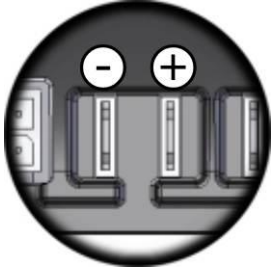
Motor Connections			
	Pin	Function	<u>Minimum Wire Gauge</u> (see notes below)
	+	Motor Positive	R50 : 2.5mm ² 13 AWG
	-	Motor Negative	R90 : 4.0mm ² 11 AWG
Mating Connector Part Numbers			
Industry standard ¼" (6.35mm) Quick Connect (QC) female receptacles, available from many manufacturers. Use only high quality parts from a reputable manufacturer.			

The wire gauge recommendations above are the MINIMUM gauge and are generally suitable for runs up to 400 mm. Longer runs will require heavier wire – typically an extra 1.0 mm² for each additional 200 mm run length. The heavier the wire, the better the driving performance will be. In particular the length and gauge of wire affects the wire resistance and hence the optimum Load Compensation setting.

Make sure that the **Load Compensation** parameter (4.4.5.5) is tuned to match the scooter wiring for best driving performance.

These notes are in addition to the General Wiring Recommendations as described in Section 3.2.2.

The motor polarity can be swapped with the **Motor Reverse** parameter (4.4.5.4).



Warning:

To meet ISO7176-14 requirements, do not use a red-coloured cable for the motor wiring. If a red-coloured cable is used, then the installer should consider sliding a different coloured sleeve (such as heat-shrink tubing) over the cable before fitting the Quick Connect receptacle. This will prevent confusion with the battery wiring.

3.3.1 Motor Protection

To prevent the motor from overheating the motor protection function can reduce the performance of the scooter when the motor consumes too much power for a prolonged period.

Enable motor protection with the **Motor Protection** parameter (4.4.5.1).



Note:

Enabling Motor Protection is only useful if its parameters are adapted to match the fitted motor. See the motor specifications given by the motor manufacturer for the correct values.

3.3.2 Motor Testing

The R-series has 4 different modes for testing the motor circuitry: All, Open, Short and None. These are configured in the Wizard with the **Motor Testing** parameter (4.4.5.12)



Warning:

It is highly recommended that motor testing is not turned off.

3.4 Park Brake Connections

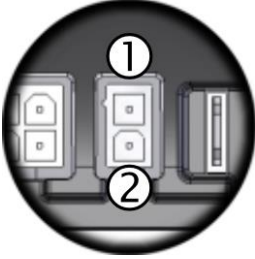
Park Brake Connections			
	Pin	Function	Wire Gauge
	1	Park Brake Positive	R50 : 0.5mm ² (20 AWG)
	2	Park Brake Negative	R90 : 0.5mm ² (20 AWG)
Mating Connector Part Numbers			
Dynamic Part #	Part Description	Supplier Part #	
GCN0884	Molex 'Mini-Fit Jr' 2-socket housing	39-01-3028	
GCN0771	Molex 'Mini-Fit Jr' Receptacles 18-24 AWG	39-00-0039	

The R-series supports a 24V park brake that is connected to the park brake connector. A manual park brake release lever can be fitted so the scooter can be pushed when the controller is turned off. To meet ISO requirements, if a manual park brake release lever is fitted, a micro switch should be connected in such a way that it inhibits driving when the park brake is released.

For example, wire a micro switch to any multi-function input that is configured to inhibit driving and mechanically couple this switch to the park brake release lever.

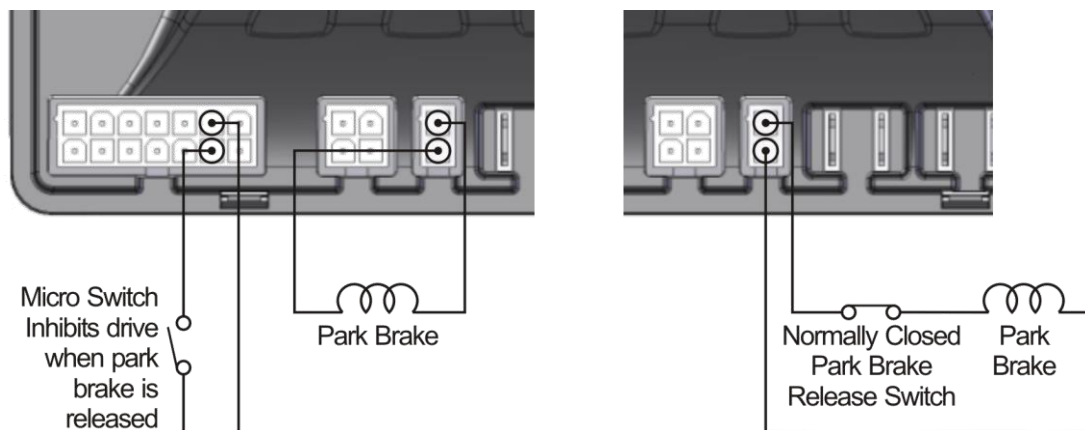

Figure 1 – Recommended Park Brake Wiring using a mechanical release lever

Figure 2 – Alternative Park Brake Wiring using a mechanical release lever

Alternatively, a normally closed micro-switch can be placed in series with the park brake. This will cause a Flash Code 5 to be displayed and the scooter will be unable to drive. To clear the fault, engage the park brake and turn the power off and then on again.

If the park brake is released when the scooter is off, the R-series reduces the speed of the scooter* if the speed of the scooter is higher than the value that is set with the **Roll-away Speed** parameter (4.4.3.14). This is to make sure that the scooter is limited to a safe speed on a slope while the park brakes are released.

*If no batteries are connected, the speed of the scooter will be limited to a crawl because the R-series needs the generated motor voltage to stay on.

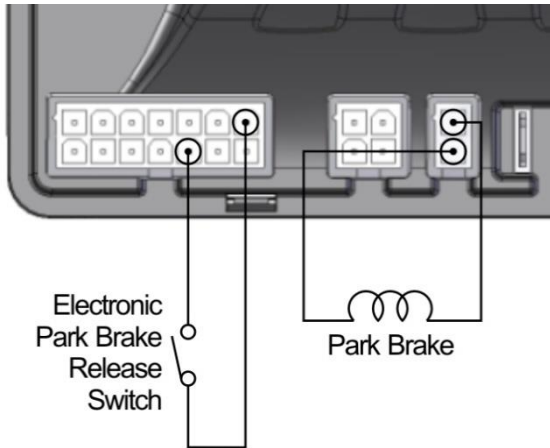

The park brake may also be released electrically by activating a switch in the tiller. Park brake release functionality is available on any of the [Multi-function Inputs](#) (3.8.1). Set the corresponding **Pin [X] Function** parameter (4.4.9.1) to 'Release Brake'.

The switch can be configured to be active in any of six states. Refer to Section 3.8.1.1 for further details about Active States.

Figure 3 - Electronic Park Brake release wiring

If the park brake is released electrically, the R-series limits the speed of the scooter to the value that is set with the **Push Speed** parameter (4.4.3.13). This is to make sure that the scooter is limited to a safe speed on a slope while the park brakes are electrically released.



Warnings:

To meet ISO requirements, the scooter must not be able to drive when the park brake is released.

The scooter must not be driven with the park brake release operated.

Do not operate the park brake release while on a slope.

3.4.1 Park Brake Testing

The R-series has 3 different modes for testing the park brake circuitry. These are selected with the **Park brake Testing** parameter (4.4.6.1).

- None** - disables all open-circuit park brake testing.
- Pre-Drive** - continuously tests that the park brake is present while not driving.
- Driving** - continuously tests the park brake is present including periodic tests while driving. This test may result in some audible noise during driving.

Regardless of the option selected, the R-series checks the park brake for short circuit faults immediately before and periodically during driving.



Warning:

Do not turn off Park Brake Testing unless there are no park brakes installed.

3.5 Battery Charging and Programming Connections

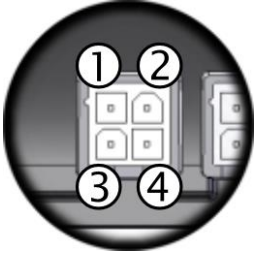
Charger/Programmer Connections			
	Pin	Function	Wire Gauge
	1	Battery Negative	1.0mm ² (18 – 16 AWG)
	2	Battery Positive	1.0mm ² (18 – 16 AWG)
	3	[no connection]	
4	Multi-function Input/Program	0.5mm ² (20 – 18 AWG)	
Mating Connector Part Numbers			
Dynamic Part #	Part Description	Supplier Part #	
GCN0886	Molex 'Mini-Fit Jr' 4-socket housing	39-01-3048	
GCN0085	Molex 'Mini-Fit Jr' Receptacles 18 -16 AWG (0.8 – 1.3 mm ² wire)	39-00-0078	
GCN0771	Molex 'Mini-Fit Jr' Receptacles 24 -18 AWG (0.2 – 0.8 mm ² wire)	39-00-0039	

3.5.1 Battery charger connections

There are two options for connecting a battery charger, either on-board (OBC) or off-board. For schematics, see the next page. If an on-board charger is installed, it is recommended to plug it directly into the Charge/Program connector. For either charging solution, a battery charger with a maximum rating of 8A RMS should be used. A suitable fuse must be installed in the Battery Positive wire to protect the scooter wiring.

For off-board chargers, an XLR-type socket can be connected either through the Charge/Program connector or through the tiller by using the Battery + and Battery - connections on the tiller connector.



Warning:

To prevent driving while charging, an appropriate inhibit pin (in either the Charge/Program or Tiller connector) must be connected so that a connection between Battery Negative (B-) and Inhibit is made when charging. For off-board chargers, this connection must be made as soon as the charger is connected to the scooter, independent of the charging state.



Warning:

The battery charger socket is to be used exclusively for the intended purpose. Warranty will be voided if any unauthorized device is connected to this port.

**Warning:**

To protect the scooter wiring from over currents while charging, battery chargers must have the ability to reduce their current output when electrically shorted.

Charger inhibit functionality is available on pin 14 and pin 4 (P/I) of the Multi-function Inputs (3.8.1). Set the corresponding Pin [X] Function parameter (4.4.9.1) to 'Charger Inhibit' and set its **Active** state to 'Low'.

Alternatively, any of the Multi-function Input pins that support the Slow function may be used. In this case, set **Slows to** 0 and set **Latches** to 'Yes'.

If **Latches** is set to 'Yes', a power cycle is required to be able to drive again.

If **Latches** is set to 'No', removing the battery charger will allow driving immediately.

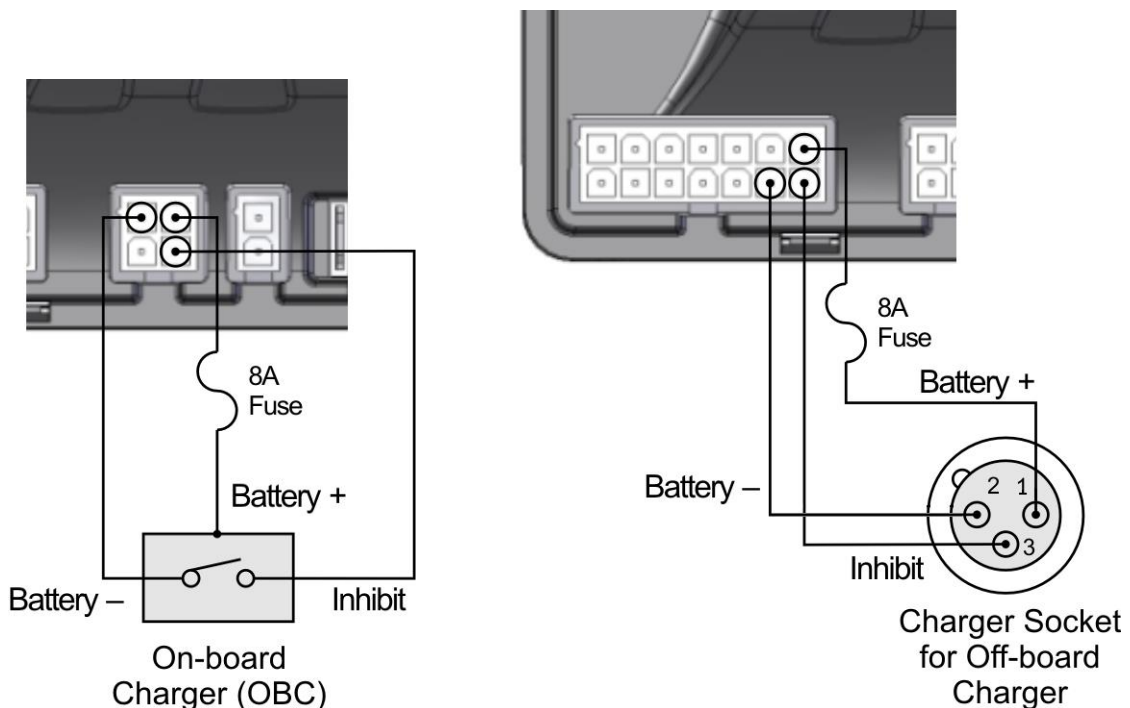

Figure 4 – Example of On-board charger wiring (shown using Charger/Programmer connector)

Figure 5 – Example of Charger Socket wiring for an Off-board charger (shown using the tiller connector)

**Note:**

The inhibit pin is a Multi-function input and can be used for an alternative function if a charger is not plugged into this pin.

**Warning:**

- 1) A suitable fuse must be installed in the Battery Positive wire to protect the scooter wiring. Fuse to be connected as close as practical to the controller connector, to minimise the length of unprotected wiring.
- 2) The Battery Positive (B+) wires (pin 2 of the 4-pin connector, and pin 7 of the 14-way connector) should be coloured 'red' to conform to ISO7176-14.

3.5.2 Programmer Connections

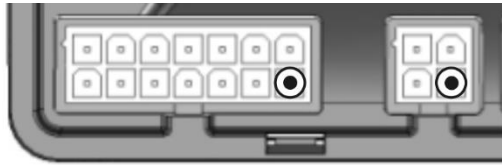

Pin 14 of the Tiller Connector and pin 4 of the charging/programming connector can both be used for programming the R-Series. Charging and programming cannot occur using the same inhibit pin at the same time.

The R-series programming adapter will plug directly into an off-board charger socket or into the 4-pin Molex Mini-Fit Junior connector with the use of the AMP programming adapter. If an on-board charger is installed, it will be necessary to disconnect it prior to programming through this connector.

The R-series can be programmed with two different programming tools:

- The DX-HHP hand held programmer (see 4.1)
- The PC-based Wizard programmer (see 4.2)

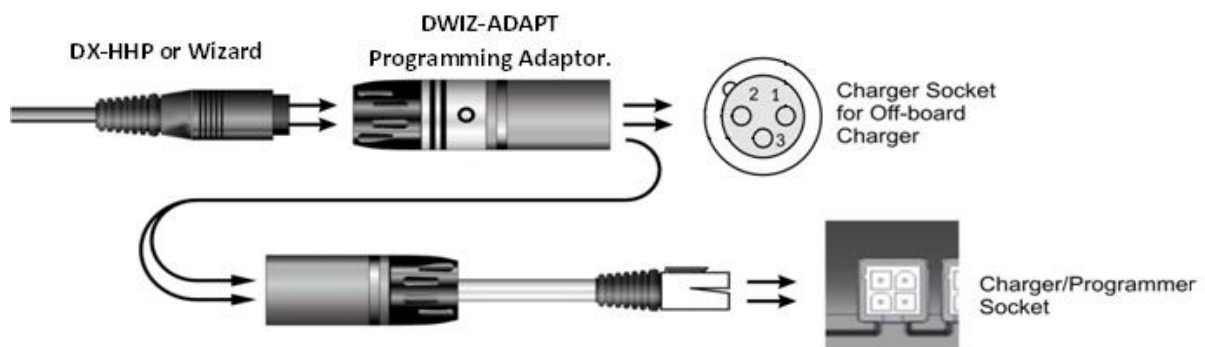

DR-PRGLM02 Connector Adaptor

Programming socket	Adaptors needed
XLR Charger socket	DWIZ-ADAPT
Charger/Programmer socket	DWIZ-ADAPT + DR-PRGLM02

3.6 Tiller Connector

The tiller connector provides all the connections necessary to power and control all the functions contained in the tiller head. This connector also supports the new Multi-function pins that can be configured for alternative functionality depending on application requirements.

Where the multi-function pins are listed below the **bold** text indicates the recommended default functions.









Tiller Connections			
	Pin	Function	Wire Gauge
	1	Throttle Wiper / 1 st Dual Decode	0.5mm ² (20 – 18 AWG)
	2	Throttle Positive	
	3	Multi-function Output (Beeper)	
	4	Multi-function Input (Profile 2)	
	5	Key Switch	
	6	Multi-function Input (Slow)	
	7	Battery Positive	1.0mm ² (18 – 16 AWG)
	8	Throttle Negative	0.5mm ² (20 – 18 AWG)
	9	Speed Limit Pot / 2 nd Dual Decode	
	10	Multi-function Output (Status Low)	
	11	Multi-function Output (none)	
	12	Multi-function Input (Reverse Drive)	1.0mm ² (18 – 16 AWG)
	13	Battery Negative	
14	Multi-function Input (Charger Inhibit)	0.5mm ² (20 – 18 AWG)	
Mating Connector Part Numbers			
Dynamic Part #	Part Description	Supplier Part #	
GCN0887	Molex 'Mini-Fit Jr' 14-socket housing	39-01-2145	
GCN0085	Molex 'Mini-Fit Jr' Receptacles 18-16 AWG (0.8 – 1.3 mm ² wire)	39-00-0078	
GCN0771	Molex 'Mini-Fit Jr' Receptacles 24-18 AWG (0.2 – 0.8mm ² wire)	39-00-0039	

**Warning:**

If a fuse greater than 5A is used to protect the battery wiring for either the 4 pin or 14 pin connectors then the battery wiring should be the maximum size allowed by the receptacles of 1.3mm² (16 AWG). This will permit the receptacle to carry its full current.

3.7 Throttle Configuration

Select the correct throttle type with the **Throttle Type** parameter (4.4.2.1):

Throttle Type	Description
Wig-Wag	   <p style="text-align: center;">Neutral Forward Reverse</p> <p>To swap the forward and reverse directions, (for left-handed use), set the Swap Throttle Direction parameter (4.4.1.3) to 'Yes'.</p>
Uni-polar	   <p style="text-align: center;">Neutral Forward* Forward*</p> <p>The scooter moves in the same direction for both sides of the throttle.</p>
Single-ended	  <p style="text-align: center;">Neutral Forward*</p> <p>Neutral is not halfway but at the start of the pot. The full speed position in a single direction is at the end of the pot.</p>

*The direction is dependent on the position of a Forward/Reverse switch. Connect this switch to one of the **Multi-function Inputs** (3.8.1), and set the corresponding **Pin [X] Function** parameter (see 4.4.9) to 'Reverse Drive'.

To have more throttle control at low speeds, increase the **Throttle Response** parameter (4.4.2.5).

3.7.1 EN12184 and ISO7176 requirements

The R-series offers OEMs a number of options for complying with international safety standards with respect to the integrity of the scooter's throttle signal.

When single fault conditions occur on a scooter, the standards require appropriate means should be adopted to eliminate or reduce, as far as possible, consequent risks.

For the throttle signal, this means an error due to an open-circuit, short-circuit or leakage current does not result in a hazardous situation. Specifically, if it is reasonably foreseeable that a short circuit, open circuit or leakage current could occur between conductors that carry analogue speed or direction signals, reference voltages, supply voltages, or actuator commands, then the identified possibilities must be tested and comply with the requirements.

The R-series now supports 3 throttle configurations:

- **Single throttle wiper → 3.7.2.**

This option is compatible with previous R-series products. However, if the installation foreseeably allows a leakage current between either a 24V supply or reference line and the speed potentiometer wiper line, the system will fail the ISO7176 leakage current requirement.

Furthermore, if a speed limit potentiometer is placed in the speed potentiometer wiper line and the installation foreseeably allows a leakage current between any other tiller connection and the speed potentiometer wiper, the system may fail the ISO7176 leakage current requirement.

**Note:**

Leakage currents could arise from rain water ingress, splashes of water off the road surface and condensation from humid situations.

- **Single throttle wiper with separate Neutral Detect switch input → 3.7.3.**

This option allows compliance for any foreseeable leakage current. The Neutral Detect switch indicates whether or not the throttle is in the physical neutral position. If the throttle signal does not match the Neutral Detect signal, the controller generates a fault and does not drive. The controller will also stop if this happens while driving.

- **A throttle with 2 linear wiper signals that are each other's opposite → 3.7.4**

This option also allows compliance for any foreseeable leakage current. If the sum of both signals is not constant, the controller generates a fault and does not drive. The controller will also stop if this happens while driving.

3.7.2 Single throttle wiper

Connect the throttle potentiometer ends to T+ (Throttle Positive, pin 2) and T- (Throttle Negative, pin 8). Connect the throttle wiper to TW (Throttle Wiper, pin 1).

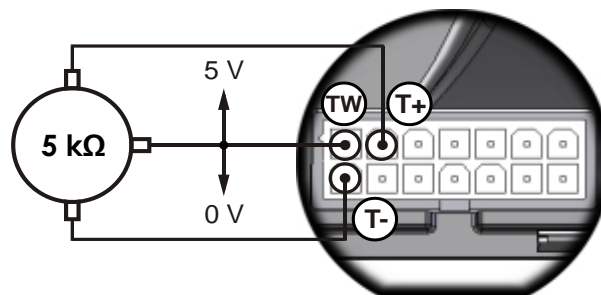

To use this option, set the **Throttle Input** parameter (4.4.2.2) to 'Single'.

**Warning:**

If the throttle potentiometer is powered externally (not by T+ and T-), take extreme care to avoid ground shift. The R-series can interpret a ground shift voltage as a drive signal and the scooter might start driving. If the throttle must be powered externally, either use additional hardware as described below or use the Neutral Detect feature (see 3.7.3) to detect a ground shift and prevent a potential runaway.

3.7.2.1 Additional hardware to comply with ISO7176-14

To make a single throttle wiper configuration compliant with the new standard, extra hardware is required. The extra hardware must check if the throttle signal is valid.

One way to achieve this is to use a Neutral Detect (ND) switch that indicates if the throttle is in the physical neutral position.

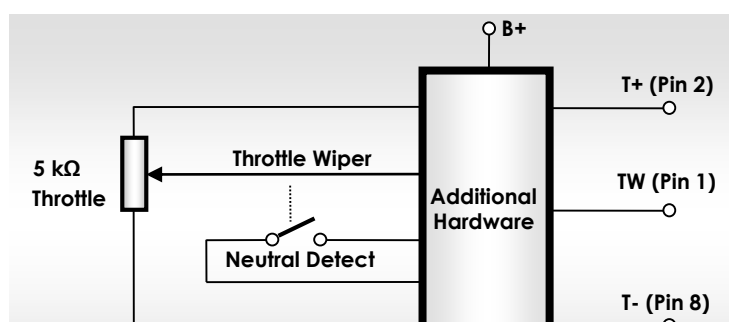

Normally, the hardware transfers the Throttle Wiper voltage to the TW output directly.

However, if the ND switch indicates "Neutral", but the wiper signal is not at the neutral value, the hardware must set the TW output to a "fault" value (higher than **Maximum Throttle Voltage** or lower than **Minimum Throttle Voltage**, see 4.4.2.8). A "fault" value causes the controller to generate a fault and prevent driving. This makes sure that the scooter will never drive if the throttle wiring is faulty. See also [Throttle Testing](#) (4.4.2.7).

The Dual Decode variants of the R-series offer a Neutral Detect input, to which a Neutral Detect switch can be connected directly without the use of additional hardware. See the next section for details.

3.7.3 Neutral Detect

The Neutral Detect function can be used in addition to a classic single wiper throttle to check whether or not the throttle is in the physical neutral position. If the throttle signal does not match the Neutral Detect signal, the controller generates a fault and does not drive. This makes sure that the scooter will never drive if the throttle wiring is faulty.

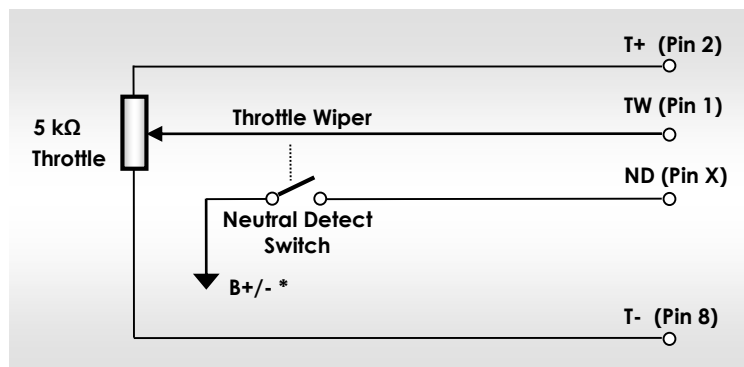

To use this option, set the **Throttle Input** parameter (4.4.2.2) to 'Single' and select the correct throttle type with the **Throttle Type** parameter (4.4.2.1). Connect the Neutral Detect switch to one of the [Multi-function Inputs](#) (3.8.1), and set the corresponding **Pin [X] Function** parameter (0) to 'Neutral Detect'.

*The Neutral Detect switch can be connected to B+ or B-, dependent on which option is selected in the **Active** field of the **Pin [X] Function** parameter. For more information, see [Active States](#) (4.4.9.2) and [Neutral Detect Active States](#) (6.1).

This option can be used with a speed limit pot in series as well as with a speed limit pot in parallel. See [Speed Limit Pot Connections](#) (3.7.6) for details.

**Note:**

The Neutral Detect function assumes that the throttle is in Neutral when the Neutral Detect input is in its active state.

For optimal mechanical accuracy, the neutral window of the Neutral Detect switch (the range of physical throttle deflection at which the switch indicates 'Neutral') should be as narrow as possible.

Make sure that the **Throttle Dead-band** parameter (4.4.2.6) is set larger than the mechanical neutral window of the Neutral Detect switch, otherwise throttle faults will occur.

If the throttle potentiometer is powered externally (not by T+ and T-), take care to avoid ground shift. Ground shift will result in a throttle fault.

Make sure that any mechanical design has the same lifespan as the throttle potentiometer.

3.7.3.1 Installation of a Neutral Detect switch

To detect the physical neutral position of the throttle potentiometer, many options are possible. Two options are shown here.

Disk with microswitch

Mount a disk to the potentiometer shaft. The disk must have a notch, in which the roller of a microswitch will fall when the throttle is in the neutral position. Fasten the disk in the correct neutral position with a screw.

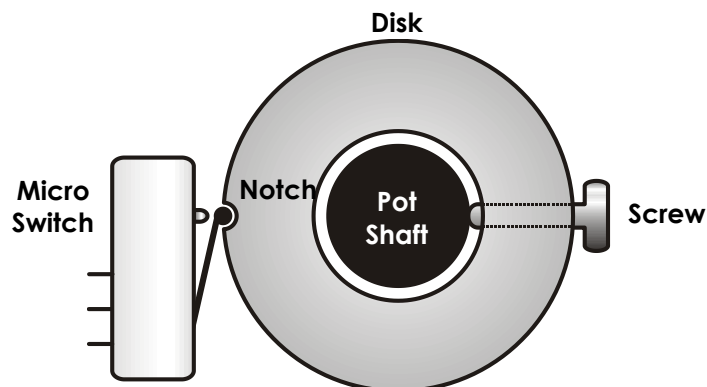

Make sure that the notch is not too deep and that it does not have sharp edges, otherwise the user may have difficulty to move the throttle out of the neutral position and the disk may slide out of position during use.

To maximise accuracy, increase the diameter of the disk.

Wear and tear will decrease accuracy. Make sure that the mechanical design conforms to the required lifespan of the throttle potentiometer.

Disk with optical switch

Many other options are possible, for example a disk with a slit that allows the light of a slotted optical switch to pass through in the neutral position.

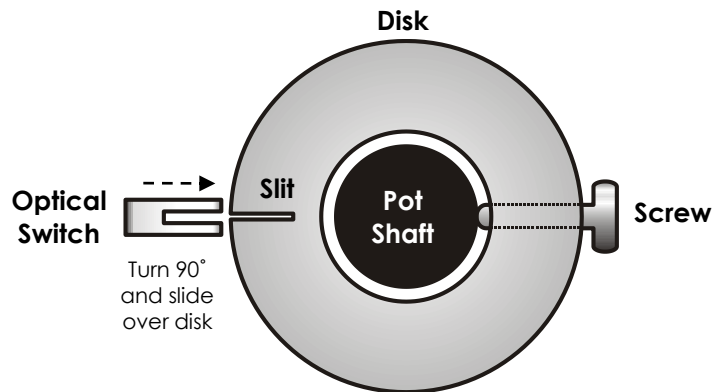

This option provides the advantage that there are no mechanical forces on the disk. The 'feel' of the throttle to the user is the same, and the chance that the disk will slide out of position during use is decreased. Also, the optical switch will probably last longer than the roller of a microswitch.

To maximise accuracy, decrease the width of the slit.

3.7.4 Two throttle wipers - mirrored

The R-series supports the use of a 2x 10 k Ω dual gang throttle with 2 linear wiper signals that are each other's opposite. The throttle can either be a short travel or long travel variant.

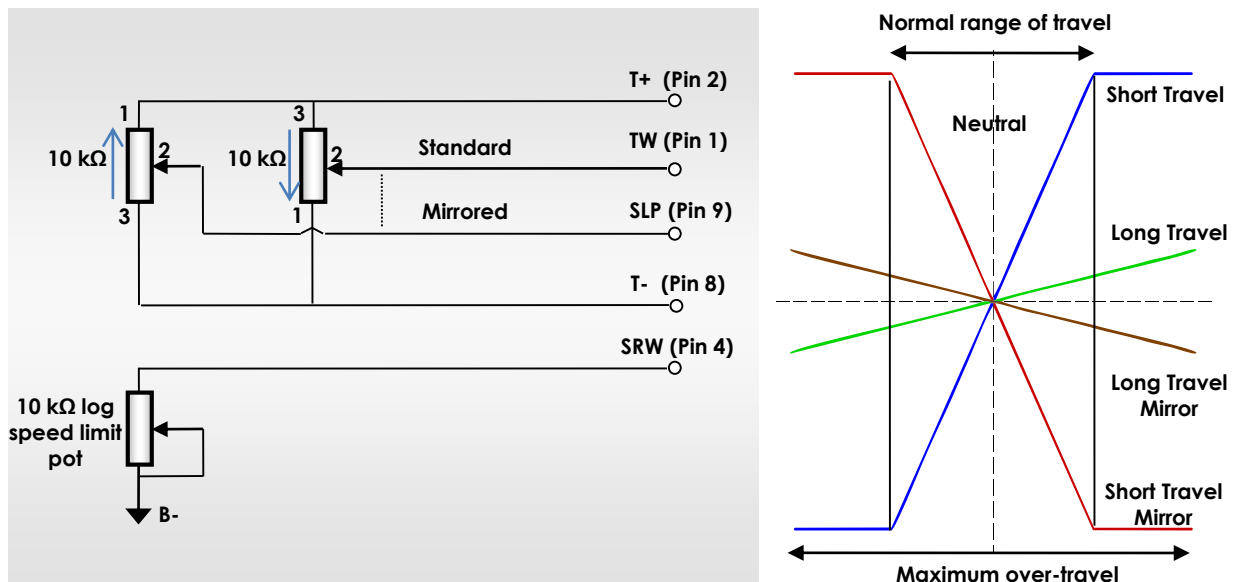

To use this option, set the **Throttle Input** parameter (4.4.2.2) to 'Dual' and select the correct throttle type with the **Throttle Type** parameter (4.4.2.1).

For a speed limit pot in series with the throttle wiper signals, insert a dual-gang speed limit pot in series, and connect both pots to the 2 throttle wiper signals.

For a speed limit pot in parallel with the throttle, it is not possible to use the dedicated Speed Limit Pot input (pin 9), because it is already used for the 2nd wiper input. To implement a variable speed reduction control, connect the wiper to pin 4 instead of pin 9, and set **Pin 4**

Function (4.4.9.1) to 'SRW'. See **Alternative Speed Reduction Options** (3.7.7) for more details.



Note:

If the throttle potentiometer is powered externally (not by T+ and T-), take care to avoid ground shift. Ground shift will result in a throttle fault.

3.7.5 Throttle Calibration

For correct throttle operation, the electrical range of the throttle must be calibrated by correctly setting **Swap Throttle Direction** (4.4.1.3), **Throttle Neutral Offset** (4.4.2.3), **Minimum Throttle Voltage** & **Maximum Throttle Voltage** (4.4.2.8), **Throttle Dead-band** (4.4.2.6) and **Throttle Full Scale Deflection** (4.4.2.4).

The HHP hand held programmer can calibrate the throttle automatically. It is recommended to use the automatic process, especially for the Dual Decode circuits.

See [Throttle calibration](#) (4.1.1.3) in the programming section for details.



Note:

*To calibrate the throttle with the Wizard PC-based programmer,
use the HHP emulator mode:*

Tools -> Plug-ins -> HHP Emulation

3.7.6 Speed Limit Pot Connections

A speed limit pot may be connected either in series with the throttle wiper, or in parallel by using the dedicated input Pin 9 (Speed Limit Pot wiper), Pin 2 (Throttle Positive) and Pin 8 (Throttle Negative).

3.7.6.1 In series with the throttle wiper



Warning:

If a series speed limit pot is used, the system will be unlikely to satisfy all of the requirements of ISO7176-14: "Controller command signal processing failure".

If wiring in series, use a 25k Ω potentiometer and set **Speed Limit Pot** (4.4.2.11) to 'No', because the dedicated speed pot input (pin 9) is not used.

To increase the chance of detecting short-circuit faults in the throttle wiring, use an ISO test resistor between the throttle wiper and the speed pot. The ISO Test resistor must be placed as close to the speed pot as possible, preferably directly soldered with as short a lead as possible and mechanically protected.

As an alternative to wiring a single ISO Test Resistor in the Throttle Wiper, two ISO Test Resistors may be added to the Throttle Positive and Throttle Negative terminal of the throttle potentiometer. This will, unfortunately, increase the susceptibility of the throttle circuit to leakage. The 2 ISO resistors must be placed as close to the throttle pot as possible, preferably directly soldered with as short a lead as possible and mechanically protected.

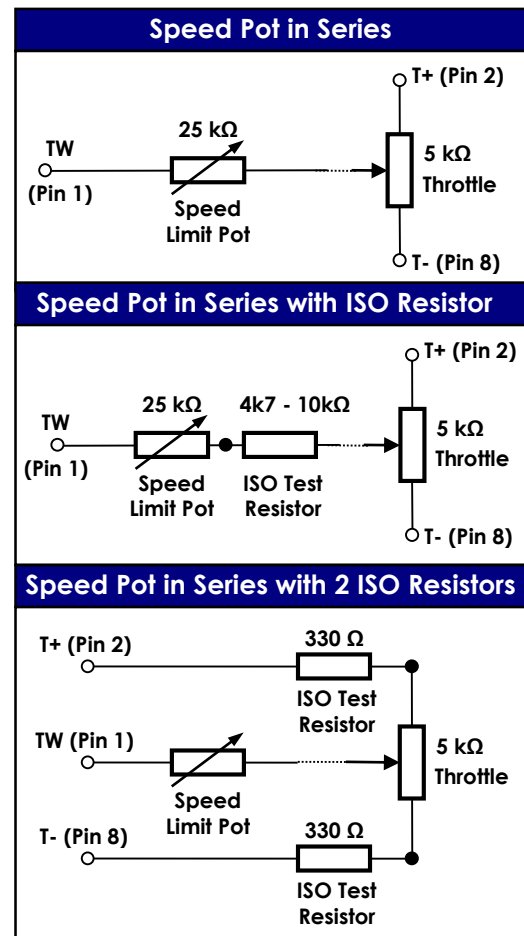

Note:

If ISO test resistors are used then it may be necessary to adjust:

- 1) the **Throttle Calibration** settings (3.7.5)
- 2) the **Throttle Configuration** parameters (4.4.2).

3.7.6.2 In parallel with the throttle

For a speed pot in parallel, use a 100k Ω potentiometer and set **Speed Limit Pot** to 'Yes'.

If the Speed Limit Pot is at its minimum position, the speed of the scooter at full throttle deflection is set by **Lowest Forward Speed** (4.4.3.7) and **Lowest Reverse Speed** (4.4.3.8).

Dual Decode variants already use pin 9 for the second throttle wiper connection. To use a separate Speed Limit Pot in parallel to the throttle with these variants, use a 10k log potentiometer. Connect it between pin 4 and B-, and set **Pin 4 Function** (4.4.9.1) to 'SRW'. If the Speed Limit Pot is at its minimum position, the speed of the scooter at full throttle deflection is set by the **Speed Reduction Wiper (SRW) parameters** (4.4.3.15).

To avoid a throttle dead band when the speed is reduced, use the 'Speed Scale' parameters and leave the 'Speed Limit' parameters at 100%.

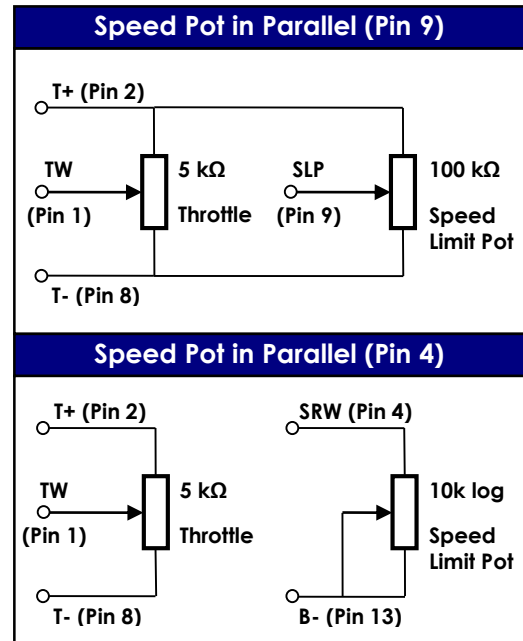

3.7.7 Alternative Speed Reduction Options

In addition to the throttle and speed limit pot, the R-series has other speed reduction options to allow for further flexibility in the way speed reduction is applied. For specific details about each of these options, please refer to the programming section:

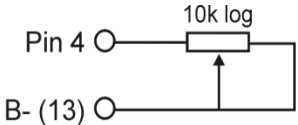
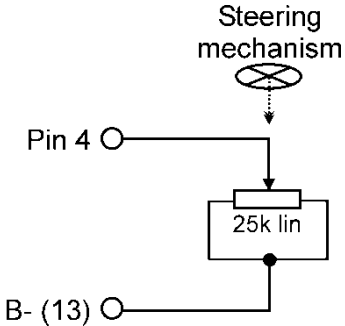
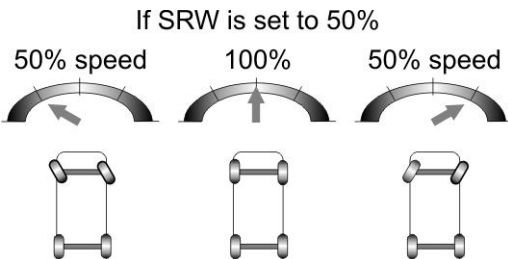
Option	Description
<p>Profile 2</p>	<p>When this function is active, the drive performance and characteristics as defined in Profile 2 will be used. The primary use of this function is to set a Reduce Speed mode.</p> <p>Available on Tiller Connector Pins 4, 6, 12, and 14 and Charger/Programmer Connector Pin 4.</p>
<p>Speed Reduction Wiper (SRW)</p>  	<p>If Pin 4 Function (4.4.9.1) is set to 'SRW', it provides a variable speed reduction dependent on the position of an external potentiometer. This function is based on the resistance between pin 4 and B- : decreasing the resistance will decrease the speed of the scooter. Decreasing resistance to zero will slow down the scooter to a speed set by the Speed Reduction Wiper (SRW) parameters (4.4.3.15).</p> <p>Proportional speed reduction</p> <p>As a conventional User Control potentiometer, the SRW supports the use of a 10k logarithmic pot wired as a variable resistor between Pin 4 and B- of the tiller. To avoid a throttle dead band when the speed is reduced, use the 'SRW Speed Scale' parameters and leave the 'SRW Speed Limit' parameters at 100%.</p> <p>Turning speed reduction</p> <p>Alternatively, this function can be used as an anti-tip feature to stop the scooter tipping while turning at a high speed, the speed being reduced dependent on how far the tiller is turned.</p> <p>In order for this function to work, mechanically connect the wiper of the external pot to the steering mechanism during installation. If the steering mechanism is in the centre position (driving straight) the wiper should also be in the centre position, providing maximum resistance. When the mechanism is turned the wiper will move off-centre, which decreases the resistance between pin 4 and B-, slowing down the scooter.</p> <p>To avoid that the scooter slows down during a turn when it is already driving at low speed, use the 'SRW Speed Limit' parameters. Leave the 'SRW Speed Scale' parameters at 100%.</p> 

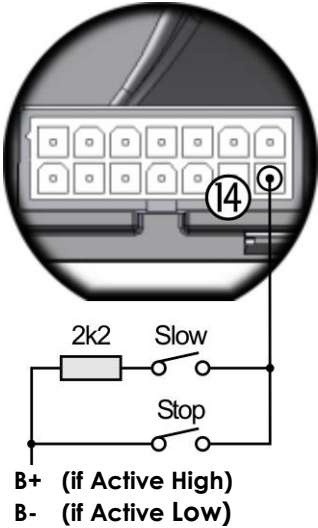
Slow	<p>Slows the scooter to a set speed limit (a percentage of the maximum speed). Has no effect on scooter acceleration or deceleration.</p> <p>Available on Tiller Connector Pins 4, 6, 12, and 14 and Charger/Programmer Connector Pin 4.</p>
Slow/Stop	<p>This function has three states: Inactive, Slow and Stop.</p> <p>When Slow is active, the scooter will slow to a programmed speed limit (a percentage of the maximum speed). Has no effect on scooter acceleration or deceleration.</p> <p>When Stop is active, the scooter will stop at the programmed Emergency Deceleration rate.</p> <p>Available on Tiller Connector Pins 4, 6, 12, and 14 and Charger/Programmer Connector Pin 4.</p> <div data-bbox="1123 450 1442 976" style="float: right;">  <p>B+ (if Active High) B- (if Active Low)</p> </div>

3.7.8 Tiller Battery Supply

Pin 7 provides the Battery Positive (B+) supply to the tiller, while Pin 13 provides the Battery Negative (B-) return. These pins have current ratings of 9A and can be used for wiring an XLR socket for an off board battery charger. An external fuse should be installed into the Battery Positive circuit. Refer to Section 3.5.1 for further details about battery charging.

The B+ and B- supplies must not be connected either directly or through switches to the same input connector.



Warnings:

A suitable fuse (8A or smaller) must be installed in the Battery Positive wire to protect the scooter wiring. Fuse to be connected as close as practical to the controller connector, to minimise the length of unprotected wiring.

In connecting switches between an input pin and either Battery Positive or Battery Negative, the installer must ensure that there is no possibility of the switch(es) connecting Battery Positive to Battery Negative.

3.7.9 Key Switch Input

Pin 5 of the analogue connector provides the key-switch power circuit. A high quality key switch (>50,000 operations) should be used. A status LED (up to 10mA) may be wired in line with this output as an alternative to using one of the Status output pins.

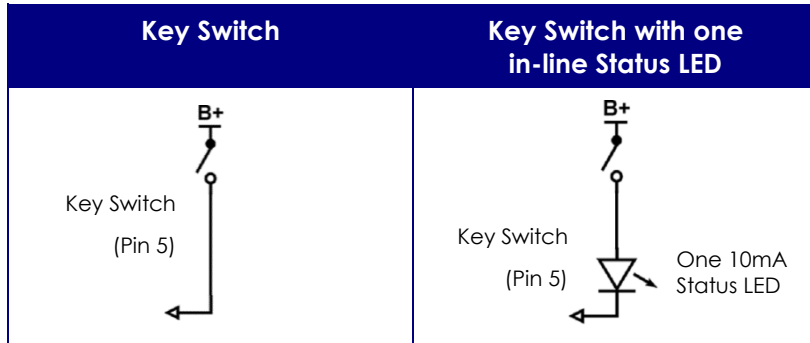

If there is no status LED wired in series with the key switch, set **Key Switch Status LED** (4.4.10.4) to 'No' to decrease the current drain by 10 mA when the R-series is turned on.

3.7.10 Status Indicator Output

Pins 3, 10, and 11 on the tiller connector can be configured as dedicated status outputs. Pin 10 also has the ability to be active either high or low.

Pin 10 is rated for 50mA sink and 10mA source, whereas Pins 3 and 11 are capable of an output up to 500mA. Select a resistor to limit LED current.

Pin 10 Status Output Options		Pin 3 and 11 Status Output Options
<p>Status High</p> <p>Status (Pin 10) 10mA Status LED</p>	<p>Status Low</p> <p>50mA Status LED</p> <p>or</p> <p>24V</p>	<p>Status</p> <p>Status LED</p> <p>or</p> <p>24V</p>
10mA at 12V	50mA at 24V	500mA at 24V



The status indicator can be configured to display 4 different types of diagnostics flash code plus battery deep discharge warning.

3.7.11 Beeper Output

Pins 3 and 11 on the tiller connector can be configured as a beeper output. They are both capable of an output up to 500mA.

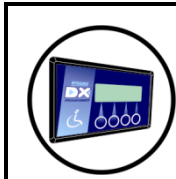
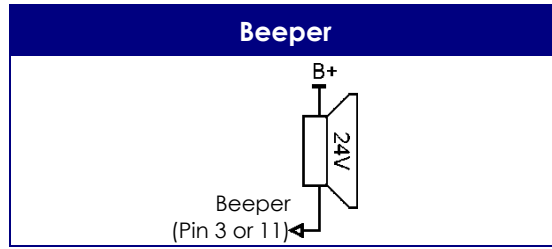

The following beeper functions can be enabled or disabled; beeping when entering sleep mode, beeping the fault codes, beeping when driving in reverse plus battery deep discharge warning.

3.7.12 Battery Gauge Output

The R-series has incorporated a battery capacity algorithm and can output this to either a 5V or 12V voltmeter battery gauge display (shown left). Alternatively, a digital LED display is supported by using the "LED Battery Gauge" wiring shown on the right. The algorithm used is the same as the Dynamic Shark powerchair controller and has built-in filters to adjust for voltage dips under load and floating voltages after periods of idling.

This function is available on Pin 10 of the Tiller Connector and is rated for 10mA source.

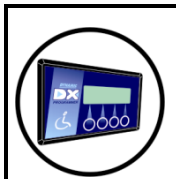
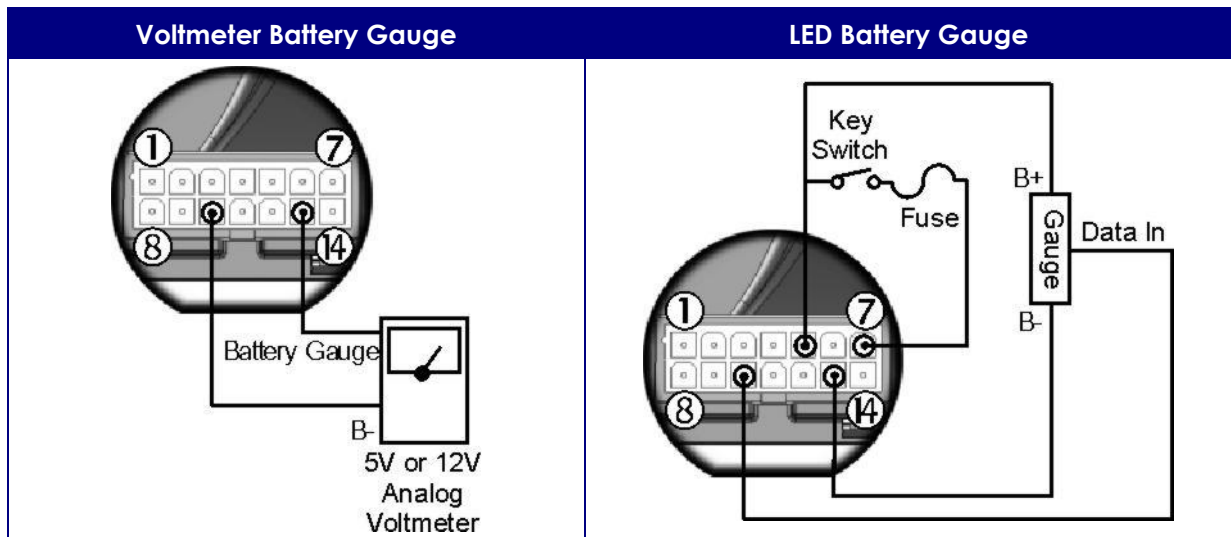

For a 5V Voltmeter Battery Gauge, set **Pin 10 Function** (4.4.10.3) to '5V Gauge'.

For a 12V Voltmeter Battery Gauge, set **Pin 10 Function** to '12V Gauge'.

For a LED Battery Gauge, set **Pin 10 Function** to 'Other'.

3.7.13 Brake and Reversing Lights

Pin 3 and Pin 11 on the tiller connector can be configured as either a brake light or reversing light. Either light output may be connected to an LED array (500mA) or relay-driven incandescent or halogen bulb.

If an LED array is used, it must be a 24V array and have its own internal current limiting system. An LED array will also need to incorporate reverse polarity protection such as a series diode.

Note: An LED array may exhibit a faint glow if not engaged. If this glow is objectionable, wire a 22kΩ resistor across the LED array terminals.

The brake light will operate whenever the controller decelerates. The reversing light will operate whenever the controller is driving in reverse.

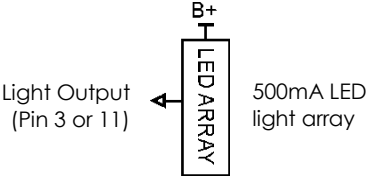
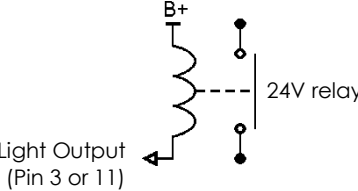
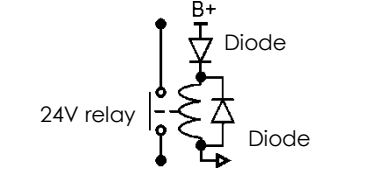
LED Lighting Output	Incandescent or Halogen bulb output	
	<p>24V Relay (<100mA)</p> 	<p>24V Relay with fly-back and series diode (<500mA)</p> 



Pins 3 and 11 can be set to one of Beeper, Brake Light, Reversing Light or Status.

3.8 Multi-function Pins

The Multi-function Pins maximise flexibility in both scooter design and installation. Allowing the ability to be configured as one of multiple functions, scooter variations typically implemented through wiring changes can now be implemented through programming.

The R-series offers both Multi-function Input and Output pins.

3.8.1 Multi-function Inputs

The Multi-function Inputs are available on pins 4, 6, 12 and 14 of the Tiller Connector and on pin 4 (Programming/Inhibit (P/I)) of the programming connector. These inputs are activated by external circuits. Each input pin can be set to operate a specific function (see table below).

Most functions are fully configurable as to the circuit state in which they are active (or operating), as well as the ability to become latched (where the controller must be turned off and then on again to cancel the function). In addition, the speed to which a Slow input decelerates is fully customisable.

The table below shows the supported functionality for each input pin. The specific functionality of each input will be explained in a further section.

	Pin 4	Pin 6	Pin 12	Pin 14	Pin P/I
Reverse Drive	•	•	•	•	•
Release Brake	•	•	•	•	•
Charger Inhibit	-	-	-	•	•
Profile 2	•	•	•	•	•
Slow	•	•	•	•	•
Slow/Stop	•	•	•	•	•
Slow/Stop Fwd	•	•	•	•	•
Slow/Stop Rev	•	•	•	•	•
SRW	•	-	-	-	-
Neutral Detect	•	•	•	•	•

For an extensive description of each function, see **Multi-function Inputs Configuration** (4.4.9).

Multi-function Inputs Configuration

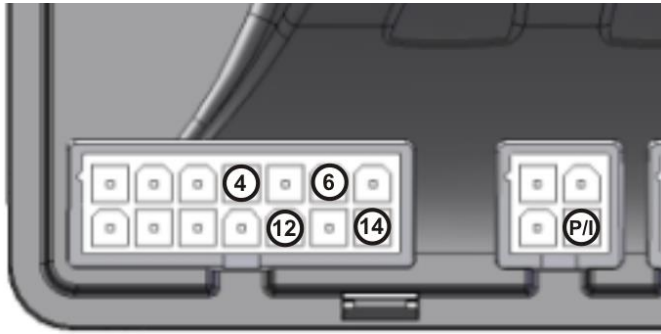

Figure 6 - Multi-function Input Pins

The configurable options for each input pin are:

- Active** – this defines the circuit state at which the function operates
- Slows to** – if a Slow function is active, this is the speed the scooter will be limited to
- Latches** – this defines whether the function is latching. If a function is latched, the active condition will have to be removed and the controller turned off and then on again before the function will be turned off. The Latches parameter applies only to the functions that inhibit driving: Charger Inhibit and Stop.
- Flashes** – during Drive Inhibit (when a Stop condition or a Charger Inhibit condition occurs) a flash code will be displayed.

Due to the nature of the different functions, some functions do not support the complete range of configuration. See the table below for further details.

	Active	Slows to	Latches	Flashes
SRW	-	-	-	-
Profile 2	•	-	-	-
Charger Inhibit	•	-	•	•
Slow	•	•	•	• (0% only)
Reverse Drive	•	-	-	-
Release Brake	•	-	-	-
Slow/Stop Fwd	•	•	•	•
Slow/Stop Rev	•	•	•	•
Slow/Stop	•	•	•	•
Neutral Detect	•	-	-	-



Note:

The three Slow/Stop functions only support Active "High" and "Low".

All other settings disable the input (the input will never become active).

3.8.1.1 Active States

If a pin is in its active state, the corresponding function will be executed.

The input pins can be set to the following active states:

- Low** - Input is active when pulled down, inactive when open or pulled up
- High** - Input is active when pulled up, inactive when open or pulled down
- Open** - Input is active when open, inactive when pulled up or pulled down
- Low or High** - Input is active when pulled down or pulled up, inactive when open
- Low or Open** - Input is active when pulled down or open, inactive when pulled up
- High or Open** - Input is active when pulled up or open, inactive when pulled down

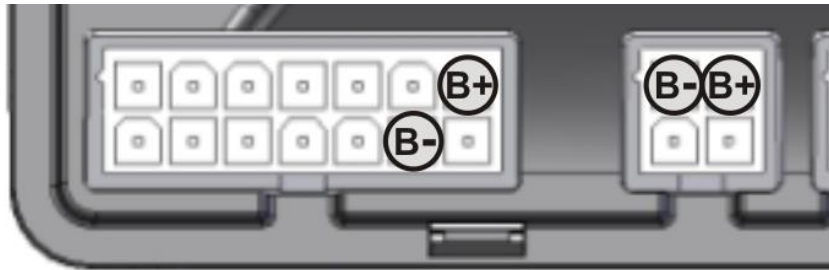

To pull up an input, connect it to B+. To pull down an input, connect it to B-.

If a multi-function input switch is connected to Pin 5 (Key Switch), put a diode in series for increased reliability. If multiple switches are connected to Pin 5 (Key Switch) it is not necessary to add a diode for each of them. One diode for all multi-function input switches combined is enough. Insert the diode as close to the switches as possible.

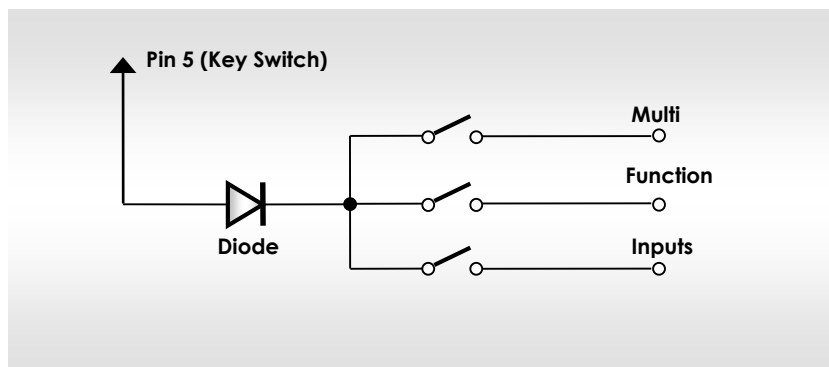

Put a diode in series if switches are connected to Pin 5 (Key Switch)

3.8.1.2 Slows to

The *Slows to* parameter sets the speed to which the controller slows down when a Slow function is active.

If set to 0%, the controller will decelerate at the programmed Emergency Deceleration rate and apply the park brake.

If set to 100%, the Slow function will have no effect.

Any values between 0% and 100% will cause the controller to decelerate using the programmed forward or reverse deceleration rate.

3.8.1.3 Latches

The *Latches* parameter sets whether the function will become latched once active. If a function is latched, the active condition will have to be removed and the controller turned off and then on again before the function will be turned off. The Latches parameter applies only to the functions that inhibit driving: Charger Inhibit and Stop.



Note:

If 'Latches' is selected, please select 'Flashes' as well to indicate to the user why the scooter will not drive.

3.8.1.4 Flashes

The Flashes parameter sets whether during a Drive Inhibit condition (when a Stop function is active or a Charger Inhibit condition occurs) a flash code will be displayed. The flash code that is displayed depends on the setting of the *Flash Code Type* parameter. See also section 5.2: [Flash Code Display](#).

3.8.2 Multi-function Outputs

The Multi-function Outputs will output signals dependent on the condition of the controller or batteries. As with the Multi-function Inputs, the Multi-function Output pins have been designed to offer maximum flexibility in the implementation of the scooter feature set and are programmable using the Wizard.

With the exception of the status output on Pin 10, these functions are not configurable as to their active state or have the ability to be latched. The specific functionality of each output will be explained in a further section.

The table below shows the supported functionality for each input pin.

	Pin 3	Pin 10	Pin 11
Beeper	•		•
Brake Light	•		•
Power Status	•		•
Reversing Light	•		•
Status	•		•
Status High		•	
Status Low		•	
5V Battery Gauge		•	
12V Battery Gauge		•	
Other (multi-LED battery gauge display)		•	

For more information, see [Multi-function Outputs Configuration](#) (4.4.10).

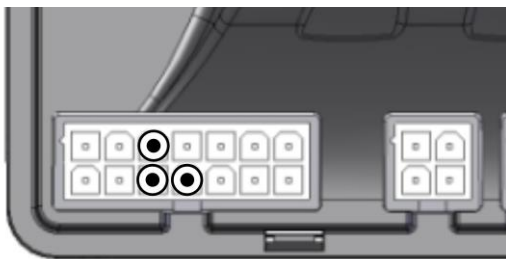

Figure 7 - Multi-function Output Pins

If deep-discharge-warning (beep on low battery) is enabled, all pins configured for 'Beeper', 'Status', or 'Status High/Low' will issue this warning. This warning takes priority over all other signalling. The warning consists of 2 short flashes and 2 short beeps every 1.8s.

3.9 Testing

To ensure that each scooter meets a minimum level of safety, the following procedure should be undertaken. This procedure should be carried out in a spacious environment and with due regard to any possible unexpected scooter movement in the event of faulty installation.

1. Raise the wheels off the ground using blocks under the scooter frame so that the wheels can turn freely.
2. Recheck all wiring, paying particular attention to polarities of batteries, motor and park brake. Most importantly, ensure that the motor and battery cables are on their own terminals and have not been interchanged.
3. Make the final connection to the Battery Positive (+) terminal, open the key switch and close the circuit breakers.
4. Turn the key-switch to turn the R-series on. Ensure it turns on correctly.
5. Turn the key-switch again to turn the R-series off. Ensure it turns off correctly. Turn the key-switch again to turn the R-series back on.
6. Ensure all installed hardware is functioning correctly by activating appropriate buttons/switches etc.
7. Move the throttle slightly out of neutral and listen for the "click" as the park brakes disengage.
8. Move the throttle backwards and forwards and ensure that the wheels respond smoothly and in the correct direction.
9. Release the throttle to neutral and listen for the click of the park brakes re-engaging.
10. Turn off the R-series and remove the blocks from under the scooter.
11. Turn the R-series back on and turn the speed dial (if installed) to the lowest speed setting.
12. Sit in the scooter and drive forward and reverse slowly, checking for precise and smooth control.
13. Repeat at higher speeds.
14. Drive the scooter on a 1:6 ramp and check for normal power, smoothness and parking.
15. Test all other hardware fitted.
16. Repeat testing until the scooter performs as expected.

4 Programming the R-series



Warning:

Performance adjustments must only be made by healthcare professionals, or by persons who completely understand the adjustment process and the capabilities of the operator.

Wrong settings, or programming in a location that is not safe, can cause injury to the operator or bystanders, or damage to the vehicle or surrounding property.

After you have configured the vehicle, check to make sure that the vehicle performs to the specifications entered in the programming procedure. If the vehicle does not perform to specifications, reprogram it. Repeat this procedure until the vehicle performs to specifications. If the wanted operation cannot be reached, contact your service agent.

Ensure that the deceleration parameters are always higher than the acceleration parameters for a safe response.

It is responsibility of the health care professional to make sure that the user is capable of both cognitively understanding and physically operating the programmed features and functions.

With inappropriate programming settings, certain features and options may not be accessible or perform as expected.

The R-series is programmed during manufacture with default settings. Modify these settings with a programmer to suit a specific scooter model or end user.

The R-series can be programmed with two different programming tools:

- The DX-HHP hand held programmer (see 4.1)
- The PC-based Wizard programmer (see 4.2)

Two different programming sockets can be used to program the R-series:

- The standard 3-pin XLR-type Battery Charger socket (if available on the scooter)
- The Charger/Programmer socket on the R-series itself.

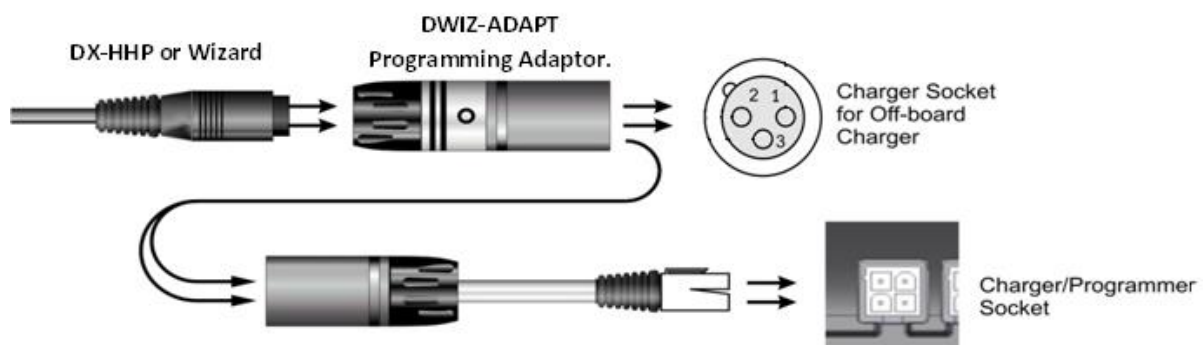



DR-PRGLM02 Connector Adaptor

Programming socket	Adaptors needed
XLR Charger socket	DWIZ-ADAPT
Charger/Programmer socket	DWIZ-ADAPT + DR-PRGLM02

4.1 The Hand Held Programmer (HHP)

The DX-HHP Hand Held Programmer (HHP) is a programming tool that gives access to drive parameters (such as speed and acceleration) and throttle calibration. A technician mode additionally gives access to system settings such as load compensation, and can read extensive system diagnostics such as motor voltage.



	<p>Note:</p> <p>The Wizard PC-based programmer has an HHP emulator mode:</p> <p>Tools -> Plug-ins -> HHP Emulation</p>
	<p>Warning:</p> <p>The DX-HHP is for use only by powerchair manufacturers and their authorised dealers. It is not for use by the powerchair user. Dealers may only program parameters as instructed by the powerchair manufacturer.</p> <p>The DX-HHP Manual should be read and understood before attempting to use the HHP.</p>

- Turn on the scooter before you connect the programmer to the R-series.
- All changes are saved immediately, it is not necessary to disconnect the HHP or to cycle the power to save changes. For this reason it is not possible to cancel a change, other than to set the parameters back to their original settings manually.

Programmer Main Menu Screen

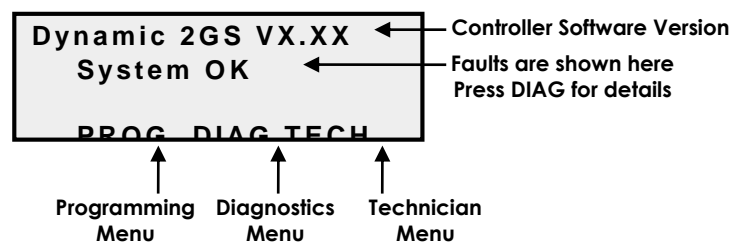

The following sections describe the menus of the HHP and give a parameter listing if applicable.

- Programming menu, 4.1.1
- Diagnostics menu, 4.1.2
- Technician menu, 4.1.3

4.1.1 Programming menu

The programming menu gives access to

- The speed and acceleration settings of Drive Profile 1 and Drive Profile 2
- Other (non-profiled) settings such as left or right handed throttle, sleep timer, beeper settings and the service scheduler
- Throttle calibration

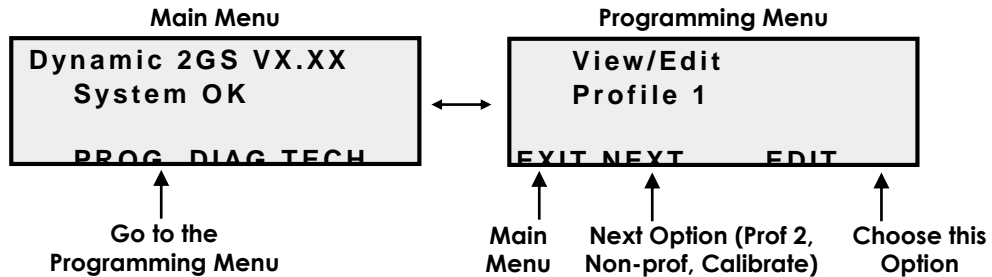

4.1.1.1 Profile 1/2

The R-series has 2 Drive Profiles that are typically used for

- Drive Profile 1 - Normal Drive
- Drive Profile 2 - A 'Slow Speed' mode for indoor use, that the user can select with a 'Slow' switch

Normally Drive Profile 1 is always selected. Drive Profile 2 is only used when **Pin [X] Function** (4.4.9.1) is set to 'Profile 2' and the associated input pin is activated.

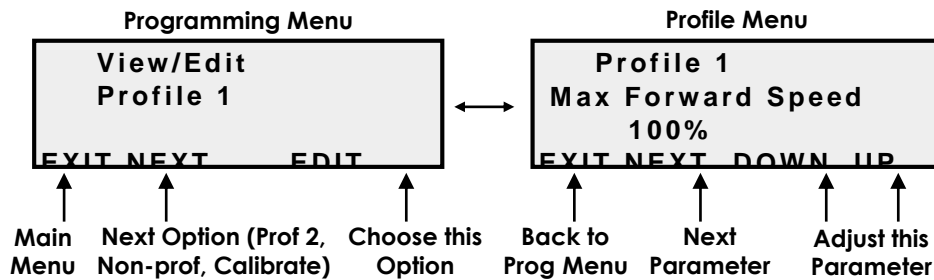

1. In the Main Menu screen, press PROG to enter the Programming Menu.
2. To select Drive Profile 1, press EDIT. To select Drive Profile 2, press NEXT and then press EDIT.
3. Press NEXT until the desired parameter is shown.
4. Press UP or DOWN to adjust the parameter to the desired value. Please note that each change is effective immediately, there is no option to cancel a change. To undo a change, manually set the parameter back to its original setting with UP or DOWN.
5. Press EXIT twice to return to the Main Menu.

For each drive profile, the following parameters can be adjusted:

Parameter	Section
Maximum Forward Speed	4.4.3.1
Forward Acceleration	4.4.3.2
Forward Deceleration	4.4.3.3
Maximum Reverse Speed	4.4.3.4
Reverse Acceleration	4.4.3.5
Reverse Deceleration	4.4.3.6
Lowest Forward Speed	4.4.3.7
Lowest Reverse Speed	4.4.3.8

4.1.1.2 Non-profiled

The parameters that are not in the Drive Profiles can be adjusted in the Non-Profiled menu.

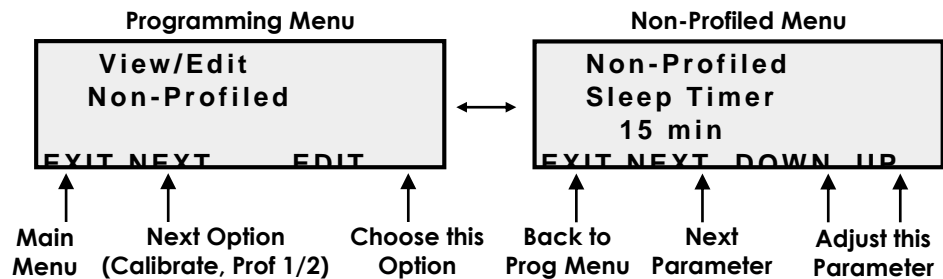

1. In the Main Menu screen, press PROG to enter the Programming Menu.
2. To select Non-Profiled, press NEXT twice and then press EDIT.
3. Press NEXT until the desired parameter is shown.
4. Press UP or DOWN to adjust the parameter to the desired value. Please note that each change is effective immediately, there is no option to cancel a change. To undo a change, manually set the parameter back to its original setting with UP or DOWN.
5. Press EXIT twice to return to the Main Menu.

In the Non-Profiled Menu, the following parameters can be adjusted:

Parameter	Section
Sleep Timer	4.4.1.1
Enable Beeper	4.4.1.4
Swap Throttle Direction	4.4.1.3
Battery Capacity (before V2 software)	4.4.7.7
BatGauge Sensitivity (after V2 software)	
Service Scheduler (Service Period)	4.4.8.1
Beep on Fault (Flash Code Beeper)	4.4.1.5
Beep on Sleep (Sleep Beeper)	4.4.1.6
Reversing Beeper	4.4.1.8
Motion Beeper	4.4.1.8

4.1.1.3 Throttle calibration

The throttle calibration automatically detects and sets the correct values for the **Swap Throttle Direction** (4.4.1.3), **Throttle Neutral Offset** (4.4.2.3), **Minimum Throttle Voltage** and **Maximum Throttle Voltage** (4.4.2.8) parameters.



Notes:

1. The HHP can only calibrate the throttle if there are no faults active, including throttle faults and OONAPU faults that are caused by a faulty calibration.
To calibrate a throttle when a throttle fault is active, set **Throttle Testing** 4.4.2.7 to 'No' with the Wizard, calibrate the unit, and then set **Throttle Testing** to 'Yes' again. For OONAPU faults, set **Throttle OONAPU Testing** 4.4.2.9 to 'None' during calibration, and return it to its original setting afterwards.
2. The throttle calibration does not set the **Throttle Dead-band** (4.4.2.6) and **Throttle Full Scale Deflection** (4.4.2.4) parameters. These parameters must still be set manually.
3. If a Speed Limiting Potentiometer (SLP) has been fitted, then the SLP must be set for full-speed when performing throttle calibration. Throttle calibration may fail if the SLP is set to a lower speed.

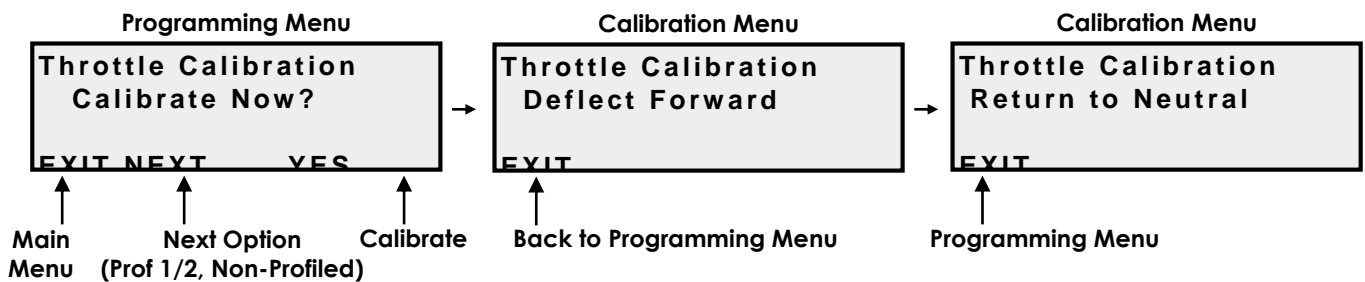

1. In the Main Menu screen, press PROG to enter the Programming Menu.
2. To select Throttle Calibration, press NEXT three times and then press YES.
3. Wait until 'Deflect Forward' is shown on the HHP.
4. Deflect the throttle FULLY forward. This procedure measures the end position of the throttle, so it is important that you deflect the throttle as far as it can go mechanically.
5. Keep the throttle deflected forward until 'Return to Neutral' is shown on the HHP.



Notes:

If the 'Return to Neutral' screen does not appear, the calibration procedure was started while a fault was active. Press EXIT to cancel the calibration procedure, eliminate the fault and start the calibration procedure again.

- Release the throttle to its neutral position.

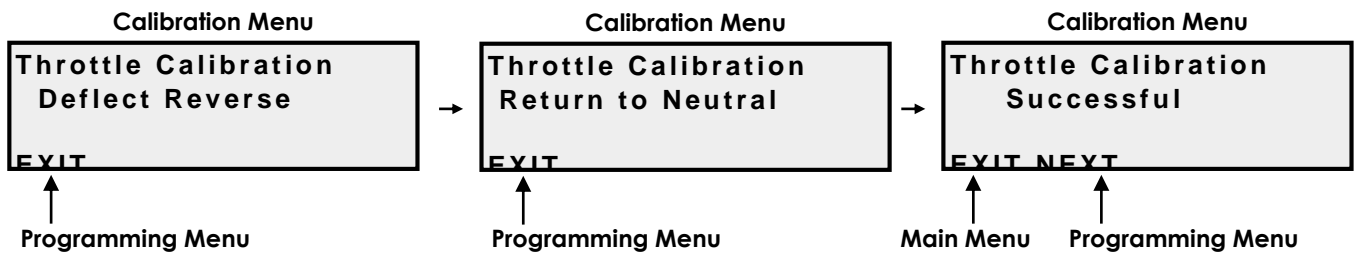

- Wait until 'Deflect Reverse' is shown on the HHP.
- Deflect the throttle FULLY reverse.
- Keep the throttle deflected reverse until 'Return to Neutral' is shown on the HHP.
- Release the throttle to its neutral position.
- If the throttle calibration is complete, the HHP will show 'Successful'.
- Press EXIT to go to the Main Menu, or press NEXT to go to the Programming Menu.

Failed calibration

If the controller cannot measure the throttle correctly, or when there is no expected throttle activity for 20 seconds during any of the calibration screens, the HHP will show 'Failed'.

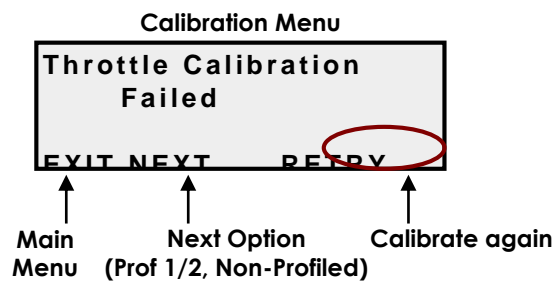

If this happens, press RETRY to repeat the calibration from the start, and go back to step 4.

4.1.2 Diagnostics menu

If a fault exists, the HHP can show extended diagnostics information.

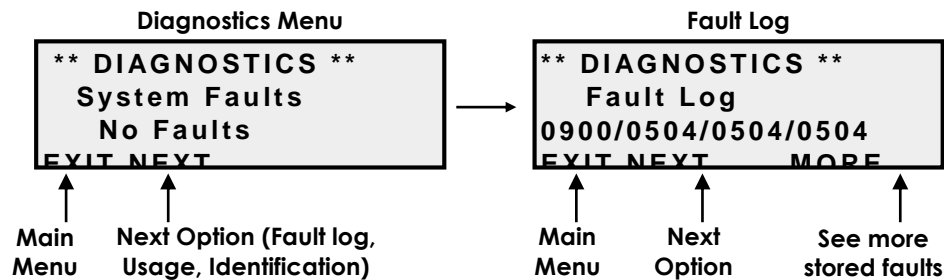

1. In the Main Menu screen, press DIAG to enter the Diagnostics Menu.
2. If a fault exists, the System Faults screen gives a description of the current fault.
3. Press NEXT for the fault log. The fault log shows the last 4 faults that have occurred. The faults are shown in 4-digit numbers. See **HHP Fault Codes with Sub Codes** (5.4) for more information. Press 'MORE' to see earlier faults; up to 16 faults can be displayed.
4. Press NEXT to access the usage counters. Press MORE to see the counters one by one.

Usage Counter	Description
Time on (h)*	The total time that the unit has been powered up
Power-ups*	The total number of successful power-ups
Drive Time (h)*	The total time during which the throttle has been deflected
Drive Count*	The total number of times that the throttle has been deflected and returned to neutral

5. Press NEXT to see the unit identification. Press MORE to see the parameters one by one: Model, ESN and Software version.

Identification	Description
Model	The model number of the unit (DR50-AD01 etc.)
ESN	The serial number of the unit
Version	The software version number of the unit

6. Press EXIT to return to the Main Menu.

*The HHP reads the currently active value of these parameters. A diagnostics report made with the Wizard shows the values that have been stored the last time that the unit was turned off. For this reason, the usage counters shown in the Wizard are usually slightly lower than the values shown in the HHP.

4.1.3 Technician menu

Some parameters are protected; they can only be accessed in Technician Mode.

To enter technician mode on the HHP:

1. Turn the R-series ON
2. Connect the HHP to the R-series
3. Press TECH

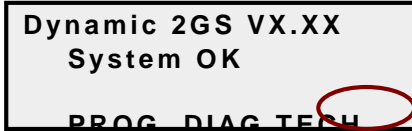

4. Enter the technician password

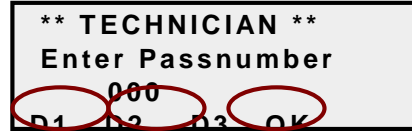

5. Press OK

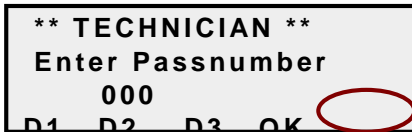

6. You are now in Technician mode.

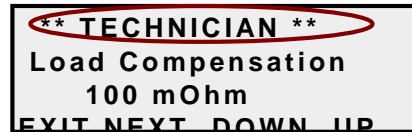

In the Technician Menu, the following parameters can be adjusted:

Parameter	Section
Load Compensation	4.4.5.5
Soft Start Period	4.4.3.9
Soft Finish	4.4.3.10

Also, the following parameters can be read real-time:

Parameter	Typical
Battery Voltage	23 - 28 V
Motor Voltage	0 - Battery Voltage
Motor Current	0 - unit rating
Controller Temperature	10 - 80 degrees
Throttle Voltage	0 - 5 V

4.2 Dynamic Wizard

The PC-based Dynamic Wizard provides access to the all parameters that are allowed to be edited or seen based on the dongle level. In addition, the Wizard can also generate comprehensive diagnostics reports. For more information, see the Wizard user manual.

4.2.1 Software revisions

Some parameters are only available to specific software revisions. A list of software revisions and which controller they refer to is given below.

Software Revision	Software version*
Rev A	Lower than 0.53
Rev B	0.53 - 1.04
Rev C	1.04 - 1.14
Rev D	1.15 - 2.0
Rev E	2.0 and higher

*You can check the software version of your controller with

- the main screen of the HHP (see 4.1).
- the Wizard: **Tools** → **Change Module Version**.

4.3 Parameter List

Key: ✓ Editable at this level (✓* = HHP Technician Mode)

👁 Viewable at this level

Par ^{C,D} Parameter only available in controllers with software Rev. C or D.

Parameter	Possible Values	Default	HHP	Lite	Std	Adv
User Personalisation (4.4.1)						
Sleep Timer	0 - 50 min	15 min	✓			✓
Wakeup Style	Key + Throttle Key Only	Key + Throttle				✓
Swap Throttle Direction	No / Yes	No	✓	✓	✓	✓
Enable Beeper	No / Yes	Yes	✓	✓	✓	✓
Flash Code Beeper	No / Yes	Yes	✓	✓	✓	✓
Sleep Beeper	No / Yes	Yes	✓	✓	✓	✓
Reverse Beeper ^{A,B,C}	No / Yes	Yes	✓	✓	✓	✓
Motion Beeper ^{D,E}	None Reverse Forward/Reverse	Reverse	✓	✓	✓	✓
Beeper On Time ^{D,E}	100 – 1500 ms	300 ms		✓	✓	✓
Beeper Off Time ^{D,E}	0 – 1500 ms	700 ms		✓	✓	✓
Deep Discharge Beeper ^E	No / Yes	Yes		✓	✓	✓
Sleep on Fault or Inhibit ^E	No / Yes	No		✓	✓	✓
Power Off after Sleep ^E	No / Yes	No		✓	✓	✓
Throttle Configuration (4.4.2)						
Throttle Type	Wig-wag Single-ended Uni-polar	Wig-wag			✓	✓
Throttle Input ^E	Single Dual**	Single			✓	✓
Throttle Neutral Offset	-0.63 - +0.62 V	0 V			✓	✓
Throttle Full Scale Deflection	20 - 100 %	85 %			✓	✓
Throttle Response	0 - 100 %	80 %		✓	✓	✓
Throttle Dead-band	0 - 100 %	15 %			✓	✓
Throttle Testing	No / Yes	Yes				✓
Maximum Throttle Voltage	0 - 5 V	4.86 V				✓
Minimum Throttle Voltage	0 - 5 V	0.16 V				✓
Throttle OONAPU Testing	None Non-Latching Latching	Non-Latching				✓
Throttle Fault Non Latching ^{B,C,D,E}	No / Yes	No				✓
Speed Limit Pot	No / Yes	Yes				✓
Slam Brake Enable ^{B,C,D,E}	No / Yes	No				✓
Slam Brake Threshold ^E	0 - 100 %	0 %				✓
Broken Wiper Wire Test	No / Yes	No				✓

Parameter	Possible Values	Default	HHP	Life	Std	Adv
Broken Wiper Wire Accuracy	0-15	0				✓
Drive Performance (4.4.3)						
Maximum Forward Speed	20 - 100 %	60 %	✓	✓	✓	✓
Forward Acceleration	0 - 100 %	40 %	✓	✓	✓	✓
Forward Deceleration	0 - 100 %	60 %	✓	✓	✓	✓
Maximum Reverse Speed	20 - 100 %	40 %	✓	✓	✓	✓
Reverse Acceleration	0 - 100 %	25 %	✓	✓	✓	✓
Reverse Deceleration	0 - 100 %	40 %	✓	✓	✓	✓
Lowest Forward Speed	0 - 100 %	20 %	✓	✓	✓	✓
Lowest Reverse Speed	0 - 60 %	10 %	✓	✓	✓	✓
Soft Start Period	0 - 2550 ms	1000 ms	✓*		✓	✓
Soft Finish	0 - 100 %	40 %	✓*		✓	✓
Emergency Deceleration	0 - 100 %	80 %				✓
Slam Braking	0 - 100 %	100 %				✓
Push Speed	15 - 100 %	40 %				✓
Roll-away Speed	30 - 100 %	40 %				✓
SRW Forward Speed Limit	0 - 100 %	50 %			✓	✓
SRW Forward Speed Scale	0 - 100 %	50 %			✓	✓
SRW Reverse Speed Limit	0 - 100 %	50 %			✓	✓
SRW Reverse Speed Scale	0 - 100 %	50 %			✓	✓
OEM Drive Limits (4.4.4)						
Maximum Forward Speed Limit	0 - 100 %	100 %			✓	✓
Maximum Reverse Speed Limit	0 - 100 %	100 %			✓	✓
Lowest Forward Speed Limit	0 - 100 %	0 %			✓	✓
Lowest Reverse Speed Limit	0 - 100 %	0 %			✓	✓
Acceleration Limit	0 - 100 %	100 %			✓	✓
Deceleration Limit	0 - 100 %	100 %			✓	✓
Motor Management (4.4.5)						
Motor Protection	No / Yes	No				✓
Motor Continuous Current	0 - 255 A	12 A (DR50) 15 A (DR90)				✓
Motor Heating Time ^{C,D,E}	0 - 255 s	20 s				✓
Motor Cooling Time ^{C,D,E}	0 - 1020 s	32 s				✓
Motor Case Time ^{A,B}	0 - 87 min	20 min				✓
Motor Brush Time ^{A,B}	0 - 326 s	20 s				✓
Motor Brush/Case Ratio ^{A,B}	0 - 100 %	30 %				✓
Motor Reverse	No / Yes	No			✓	✓
Load Compensation	0 - 1020 mΩ	100 mΩ	✓*		✓	✓
Maximum Load Compensation	0 - 1020 mΩ	1000 mΩ				✓
Load Compensation Damping	0 - 60%	50%				✓
Remembered Load Compensation	0 - 60%	50%				✓
Current Limit	0 - 40 A (DR50) 0 - 70 A (DR90)	40 A			✓	✓
Boost Current	0 - 10 A (DR50) 0 - 20 A (DR90)	8 A			✓	✓
Boost Time	0 - 51 s	4 s			✓	✓
Stall Timeout	0 - 51 s	25 s				✓

Parameter	Possible Values	Default	HHP	Life	Std	Adv
Motor Testing	None Open Short All	Short				✓
Maximum Motor Voltage	2 – 40.2 V	28.8 V				✓
Deadtime Adjust	0-4	0				✓
Park brake Management (4.4.6)						
Park brake Testing	None Pre-drive Driving	Pre-drive				✓
Park brake Neutral Delay	0 - 25500 ms	2000 ms			✓	✓
Park Brake Release Delay	0 - 25500 ms	0 ms			✓	✓
Battery Management (4.4.7)						
Overvoltage Warning	24 – 34.2V	30.2V				✓
Overvoltage Rollback	30.2 – 34.8V	34.2V				✓
Undervoltage Rollback Start	18 - 32.2 V	21 V				✓
Undervoltage Rollback End	17 - 21 V	18 V				✓
Battery Gauge Minimum	16 - 24 V	22 V				✓
Battery Gauge Maximum	19 - 27 V	24.4 V				✓
Battery Gauge High Warning	24 - 32 V	29 V			✓	✓
Battery Gauge Low Warning	18 - 26 V	23.4 V			✓	✓
Battery Gauge Dead-band	0 - 6 V	3.5 V				✓
Battery Gauge Sensitivity	0 - 170	40	✓			✓
Battery Cut-Off Voltage ^E	16 - 24 V	19.1 V		✓	✓	✓
System Options (4.4.8)						
Service Scheduler	No / Yes	Yes			✓	✓
Service Period	0 - 5100 h	5000 h	✓	✓	✓	✓
Multi-function Inputs Configuration (4.4.9)						
Pin 4 Function	None Reverse Drive	None			✓	✓
Pin 6 Function	Release Brake Charger Inhibit				✓	✓
Pin 12 Function	Profile2 Slow				✓	✓
Pin 14 Function	Slow/Stop Slow/Stop FWD Slow/Stop REV				✓	✓
Prog/Inh Pin Function	SRW Neutral Detect**				✓	✓

**Dual Decode variants only (see chapter 1)

Multi-function Outputs Configuration (4.4.10)						
Flash Code Type	Scooter Shark Type 3 Type 4	Scooter			✓	✓
Pin 3 Function	None Brake Light Reverse Light	Beeper			✓	✓
Pin 11 Function	Beeper Status Power Status	Status			✓	✓
Pin 10 Function	None Status High Status Low 5V Gauge 12V Gauge Other	None			✓	✓
Key Switch Status LED	No / Yes	Yes				✓

4.4 Parameter Descriptions



Warning:

- The default settings in this section must be used as a guideline only. Their values may deviate from the default values as shown by the Wizard.
- It is the responsibility of the powerchair manufacturer to make sure that the program is safe and suitable for a particular scooter configuration.
- It is the responsibility of the dealer or therapist to check and make sure that the settings of a scooter for a particular user are safe and appropriate for that user.

4.4.1 User Personalisation

4.4.1.1 Sleep Timer

Parameter	Possible Values	Default	HHP	Lite	Std	Adv
Sleep Timer	0 - 50 min	15 min	✓			✓

The R-series automatically "goes to sleep" if the throttle has been in the Neutral position for **Sleep Timer** minutes. When the R-series sleeps, it is partially turned off to reduce energy consumption and to make sure that the scooter does not move when the user accidentally moves the throttle. In Sleep Mode, the scooter does not respond to commands.

To wake up the R-series, take the action that is selected with **Wakeup Style**.

If **Wakeup Style** is set to 'Key + Throttle', the Status Light gives a short flash every 5 seconds during sleep mode.

To disable Sleep Mode, set **Sleep Timer** to zero.

4.4.1.2 Wakeup Style

Parameter	Possible Values	Default	HHP	Lite	Std	Adv
Wakeup Style	Key + Throttle Key Only	Key + Throttle				✓

Defines how the controller will wake up from sleep.

Key Only - Only the key switch wakes up the controller (by turning the key off and then on again).

Key + Throttle - The key switch as well as any throttle movement wakes up the controller.

4.4.1.3 Swap Throttle Direction

Parameter	Possible Values	Default	HHP	Lite	Std	Adv
Swap Throttle Direction	No / Yes	No	✓	✓	✓	✓

This parameter is only used when **Throttle Type** (4.4.2.1) is set to 'Wig-wag'. For single-ended throttles, use a Forward/Reverse switch instead (see 4.4.9.1).

Yes - The polarity of the throttle is reversed. Moving the throttle in the direction that normally causes forward movement now results in reverse movement while the reverse buzzer beeps. Typically used for left-handed operation.

No - The polarity of the throttle is normal. Typically used for right-handed operation.



Notes:

The **Motor Reverse** parameter (4.4.5.4) also reverses the direction of the scooter, but it does not swap the behaviour of the reversing buzzer or the speed limit parameters. If **Motor Reverse** is set to 'Yes', the reversing buzzer will beep when the scooter moves forward, and the forward speed will be limited by the **Maximum Reverse Speed** parameter. For this reason, do not use **Motor Reverse** for left-handed operation. Use **Swap Throttle Direction** instead.

4.4.1.4 Enable Beeper

Parameter	Possible Values	Default	HHP	Lite	Std	Adv
Enable Beeper	No / Yes	Yes	✓	✓	✓	✓

Yes - The beeper will beep according to the settings of **Flash Code Beeper**, **Sleep Beeper**, **Motion Beeper** and **Deep Discharge Beeper**.

No - All beeper functions are disabled.

4.4.1.5 Flash Code Beeper

Parameter	Possible Values	Default	HHP	Lite	Std	Adv
Flash Code Beeper	No / Yes	Yes	✓	✓	✓	✓

This parameter is only used when **Enable Beeper** has the value 'Yes'.

Yes - If a flash code is shown on the Status LED, the buzzer beeps the same number of beeps as the flash code number.

No - The buzzer does not beep during a fault.

4.4.1.6 Sleep Beeper

Parameter	Possible Values	Default	HHP	Lite	Std	Adv
Sleep Beeper	No / Yes	Yes	✓	✓	✓	✓

This parameter is only used when **Enable Beeper** has the value 'Yes'.

Yes - When the controller goes to sleep, the buzzer beeps for one second.

No - When the controller goes to sleep, the buzzer does not beep.

4.4.1.7 Reverse Beeper

Parameter	Possible Values	Default	HHP	Lite	Std	Adv
Reverse Beeper	No / Yes	Yes	✓	✓	✓	✓

This parameter is only used when **Enable Beeper** has the value 'Yes'.

Yes - The scooter beeps only when it is moving in the reverse direction

No - The scooter does not beep when it is moving

If **Motion Beeper** has the value 'Forward/Reverse' or 'Yes' (HHP), the value of **Reverse Beeper** is ignored and the scooter will beep when it is moving in any direction, including reverse.

4.4.1.8 Motion Beeper

Parameter	Possible Values	Default	HHP	Lite	Std	Adv
Motion Beeper	None Reverse Forward/Reverse	Reverse		✓	✓	✓
	Yes (HHP) No (HHP)	No (HHP)	✓			

This parameter is only used when **Enable Beeper** has the value 'Yes'.

None / No (HHP) - The scooter does not beep when it is moving

Reverse - The scooter beeps only when it is moving in the reverse direction

Forward/Reverse - The scooter beeps when it is moving in any direction

Yes (HHP)

4.4.1.9 Beeper Timing

Parameter	Possible Values	Default	HHP	Lite	Std	Adv
Beeper On Time	100 – 1500 ms	300 ms		✓	✓	✓
Beeper Off Time	0 – 1500 ms	700 ms		✓	✓	✓

These parameters are only used when **Enable Beeper** has the value 'Yes'.

Beeper On Time and **Beeper Off Time** together set the beeper interval time. During **Beeper On Time** the beeper emits a sound. During **Beeper Off Time** the beeper is silent.

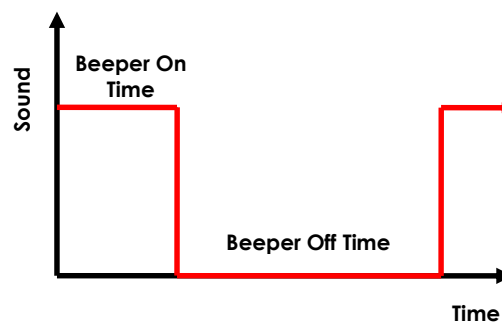

4.4.1.10 Deep Discharge Beeper

Parameter	Possible Values	Default	HHP	Lite	Std	Adv
Deep Discharge Beeper	No / Yes	Yes		✓	✓	✓

This parameter is only used when **Enable Beeper** has the value 'Yes'.

Enables beeping if the battery is drained below the cut-off level that is set by **Battery Cut-Off Voltage** (4.4.7.5).



Note:
 This parameter needs to be set to comply with the ISO7176-14 'over-discharge protection' requirement.

4.4.1.11 Sleep on Fault or Inhibit

Parameter	Possible Values	Default	HHP	Lite	Std	Adv
Sleep on Fault or Inhibit	No / Yes	No		✓	✓	✓

Enables going to sleep if a fault or inhibit condition is active. If set to no, the unit will not go to sleep, but will signal the fault indefinitely.



Note:
 If the value of **Sleep Timer** is zero, the value of **Sleep on Fault or Inhibit** is ignored.
 During a throttle fault or OONAPU fault the controller will never go to sleep, even if this parameter is set to 'Yes'.

4.4.1.12 Power Off after Sleep

Parameter	Possible Values	Default	HHP	Lite	Std	Adv
Power Off after Sleep	No / Yes	No		✓	✓	✓

Enables powering the unit off automatically after sleeping for approximately 6 hours to save battery power.

4.4.2 Throttle Configuration

4.4.2.1 Throttle Type

Parameter	Possible Values	Default	HHP	Lite	Std	Adv
Throttle Type	Wig-wag Single-ended Uni-polar	Wig-wag			✓	✓

Wig-Wag - The throttle controls speed and direction, no Forward/Reverse switch is required. The neutral position is halfway the pot.
If the throttle is moved out of the centre position in one direction, the scooter drives forward. If the throttle is moved out of the centre in the opposite direction, the scooter drives in reverse. The standard direction of the scooter can be swapped with **Swap Throttle Direction** (4.4.1.3).

Single-Ended - The throttle controls speed only. The neutral position is at the start of the pot. The direction of the scooter is selected with a Forward/Reverse switch.

Uni-polar - The throttle controls speed only. The neutral position is halfway the pot. If the throttle is moved out of the centre position in either direction, the scooter starts to drive in the direction that has been selected with the Forward/Reverse switch. This allows left-handed and right-handed operation of the same wigwag without reprogramming the scooter.

If a Forward/Reverse switch is needed, connect it to one of the [Multi-function Inputs](#) (3.8.1), and set the corresponding **Pin [X] Function** parameter (see 4.4.9) to 'Reverse Drive'.

For schematics, see [Throttle Configuration](#) (3.7).

4.4.2.2 Throttle Input

Parameter	Possible Values	Default	HHP	Lite	Std	Adv
Throttle Input	Single Dual	Single			✓	✓

Single - Use for a standard throttle with a single wiper.
The only valid choice for all controllers except the dual decode variants.

Dual - Use for a throttle with 2 linear wiper signals that are each other's opposite. In the extreme positions, one wiper is set to the minimum value and the other wiper is set to the maximum value. In the halfway position, both wipers have the same value. The R-series checks both signals for consistency: the sum of both signals must be a constant value, equal to the maximum value. If the sum of the signals is more than 10% lower or higher than the expected maximum value, the scooter stops and a throttle fault is shown on the Status light.
Only valid on Dual Decode variants. Not valid on all other controllers.

4.4.2.3 Throttle Neutral Offset

Parameter	Possible Values	Default	HHP	Lite	Std	Adv
Throttle Neutral Offset	-0.63 - +0.62 V	0 V			✓	✓

Set this to account for any slight mechanical offset between the throttle neutral position and the centre position of the throttle wiper. The offset is an absolute voltage above or below neutral.

Use the HHP to calibrate the unit instead of setting a value manually, see [Throttle calibration \(4.1.1.3\)](#) for details.

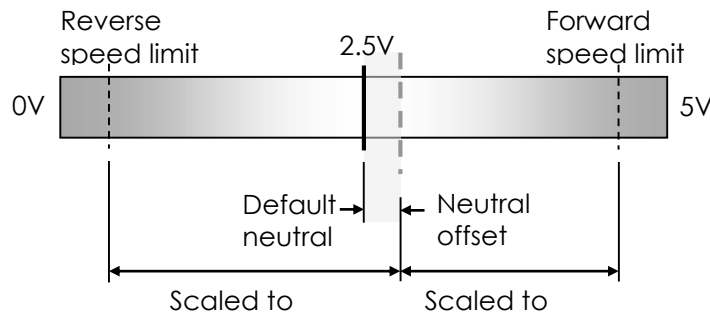

The default neutral value is dependent on the value of the **Throttle Type** parameter (4.4.2.1):

- Wig-Wag and Uni-polar both have the default neutral value at 2.5 V.
- Single-ended has its default neutral value at 0 V + **Minimum Throttle Voltage** (4.4.2.8). In this case all negative values of **Throttle Neutral Offset** are ignored and all positive values are multiplied by 2, which means that a Wizard setting of 0.5V will produce an actual neutral offset of 1.0V.

4.4.2.4 Throttle Full Scale Deflection

Parameter	Possible Values	Default	HHP	Lite	Std	Adv
Throttle Full Scale Deflection	20 - 100 %	85 %			✓	✓

Set the percentage of total throttle movement that will result in full speed.

The scale of this parameter ranges between **Throttle Neutral Offset** (0%) and **Maximum Throttle Voltage/ Minimum Throttle Voltage** (100%).

For example, if a mechanical stop restricts the throttle from moving more than 60% of its full electrical travel, set this parameter to 50% to make sure that the scooter can still reach maximum speed.

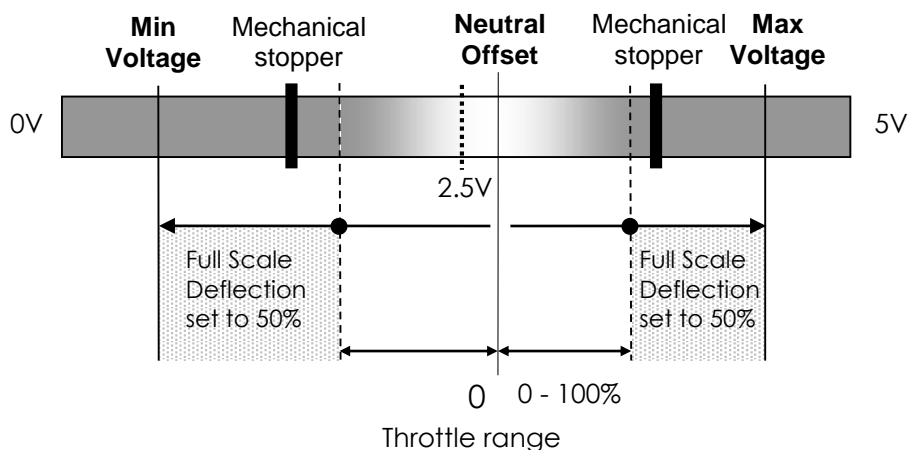

4.4.2.5 Throttle Response

Parameter	Possible Values	Default	HHP	Lite	Std	Adv
Throttle Response	0 - 100 %	80 %		✓	✓	✓

Defines the scooter response to movement of the throttle.

- 0% - The response to the throttle is linear. If the throttle is held halfway, the scooter will drive at half its programmed speed.
- 100% - The response to the throttle is curved. If the throttle is held halfway, the scooter will drive at around 25% of its programmed speed. This gives the user finer control at low speed. The curve does not change the maximum speed, so the scooter will still drive at full maximum speed when the throttle is fully deflected.

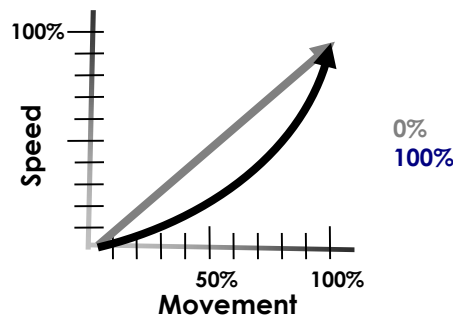

4.4.2.6 Throttle Dead-band

Parameter	Possible Values	Default	HHP	Lite	Std	Adv
Throttle Dead-band	0 - 100 %	15 %			✓	✓

Also commonly referred to as 'Neutral Window', **Throttle Dead-band** sets how far the throttle must be moved out of neutral before the controller will begin to drive. The percentage range is dependent on the value of the **Throttle Type** parameter (4.4.2.1).

The speed demand from the throttle remains at zero while the throttle deflection from neutral is less than half of the programmed Throttle Dead-band. As the throttle is deflected beyond this point and up to the programmed Dead-band, the throttle demand increases smoothly from zero so that there is no abrupt change in demand as the throttle moves out of neutral. For a throttle deflection greater than the programmed Dead-band the speed demand is proportional to the throttle deflection.

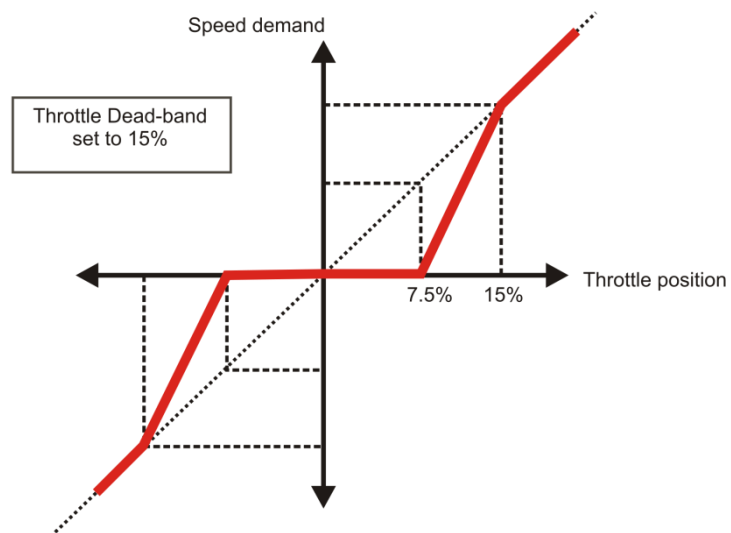

4.4.2.7 Throttle Testing

Parameter	Possible Values	Default	HHP	Lite	Std	Adv
Throttle Testing	No / Yes	Yes				✓

- Yes** - The R-series tests if the voltage at the throttle wiper has a value that is between **Minimum Throttle Voltage** and **Maximum Throttle Voltage**. This is especially useful when ISO resistors are used to detect faults in the throttle wiring. If the voltage falls more than 10% outside the limits, a throttle fault is generated, the scooter will not drive and a 'Throttle Fault' flash code is shown on the Status light. For the correct flash code, see the description of the **Flash Code Type** parameter (4.4.10.1).
- No** - The R-series does not generate throttle faults. This setting is not recommended because faults in the throttle wiring may not be detected. Use for throttle calibration and throttle testing only.

For schematics and the use of ISO resistors, see Throttle Configuration (3.7).

4.4.2.8 Maximum Throttle Voltage

Parameter	Possible Values	Default	HHP	Lite	Std	Adv
Maximum Throttle Voltage	0 - 5 V	4.86 V				✓
Minimum Throttle Voltage	0 - 5 V	0.16 V				✓

Maximum Throttle Voltage sets the maximum expected throttle voltage. Set this parameter to the voltage that is present at the R-series throttle wiper input (pin 1 of the tiller head connector) when the wiper of the throttle is moved fully to the Throttle Positive position (pin 2).

Minimum Throttle Voltage sets the minimum expected throttle voltage. Set this parameter to the voltage that is present at the R-series throttle wiper input when the wiper of the throttle is moved fully to the Throttle Negative position (pin 2).

The Minimum and maximum throttle voltage parameters determine the operation of the **Throttle Full Scale Deflection** (4.4.2.4) and **Throttle Dead-band** (4.4.2.6) parameters. See the description of those parameters for details.

If **Throttle Testing** is set to 'Yes', and the voltage at the throttle wiper input is more than 10% higher than **Maximum Throttle Voltage** or 10% lower than **Minimum Throttle Voltage**, the controller generates a throttle fault to indicate that an error may have occurred with the throttle or its wiring.

FSD Fwd:	$2 + (4.5 - 2) \times 80\% = 4.0V$
DB Fwd:	$2 + (4.0 - 2) \times 25\% = 2.5V$
FSD Rev:	$2 - (2 - 0.5) \times 80\% = 0.8V$
DB Rev:	$2 - (2 - 0.8) \times 25\% = 1.7V$

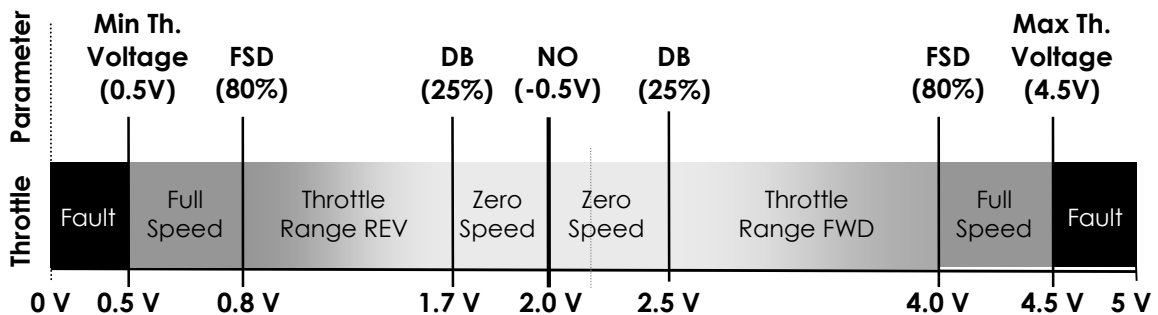

Wig-wag setup with Neutral Offset = -0.5 V, Dead-band = 25% and Full Scale Deflection = 80%

4.4.2.9 Throttle OONAPU Testing

Parameter	Possible Values	Default	HHP	Lite	Std	Adv
Throttle OONAPU Testing	None Non-Latching Latching	Non-Latching				✓

An **Out Of Neutral At Power Up** (OONAPU) fault occurs if the throttle is not in the neutral position when the scooter is switched on. This makes sure that the scooter does not suddenly start to drive.

If an OONAPU fault exists, the Status LED shows a flash code* and the scooter does not drive. Return the throttle to the neutral position. The fault goes away and the scooter drives normally.

Latching - If the throttle is not returned to the neutral position within 5 seconds, the OONAPU fault becomes a latching fault. To clear the fault, switch the scooter off and then on again.

Non-Latching - The OONAPU fault never becomes a latching fault. To clear the fault, simply return the throttle to the neutral position. Use this setting for users who have difficulty to return the throttle to the neutral position within 5 seconds.

None - An OONAPU fault will never occur.
Do not use except for testing purposes or throttle calibration.

*The flash code that is shown depends on the **Flash Code Type** parameter (4.4.10.1).



Note:

If an OONAPU fault does not go away after the scooter has been turned off and on, the throttle may be faulty or incorrectly calibrated. See section 3.7.5 for more information.



Warning:

*If **Throttle OONAPU Testing** is set to 'None', the scooter is unsafe for normal operation. The scooter can start to drive unexpectedly if it is turned on while the throttle is stuck in a deflected position.*

4.4.2.10 Throttle Fault Non Latching

Parameter	Possible Values	Default	HHP	Lite	Std	Adv
Throttle Fault Non Latching	No/Yes	No				✓

Set to 'Yes' for non-latching throttle faults, set to 'No' for latching throttle faults.



Warning:

Only set this parameter to 'Yes' for testing purposes. If throttle faults are non-latching, the scooter immediately starts to drive at the speed that the throttle is held at when a throttle fault disappears. This can easily happen with a throttle that is not calibrated correctly.

4.4.2.11 Speed Limit Pot

Parameter	Possible Values	Default	HHP	Lite	Std	Adv
Speed Limit Pot	No / Yes	Yes				✓

Yes - The dedicated Speed Limit Pot input (pin 9) is used to limit the speed of the scooter. Use this setting with a 100 k Ω speed pot that is connected IN PARALLEL with the throttle, between 'Throttle Positive' (pin 2) and 'Throttle Negative' (pin 8), and that has its wiper connected to pin 9 (speed limit pot input).

No - The Speed Limit Pot input (pin 9) is ignored. Use this setting with a 25 k Ω speed pot that is connected IN SERIES with the throttle, and that is connected to pin 1 (throttle wiper input).

For schematics and the use of ISO resistors, see [Speed Limit Pot Connections](#) (3.7.6).



Note:

If **Speed Limit Pot** is set to 'Yes' when no speed pot is connected to pin 9 (when the speed pot is wired in series with the throttle instead of in parallel), the R-series will read pin 9 as if the speed pot is at its lowest setting, and will always limit the speed of the scooter to the lowest forward and reverse speeds.

If the voltage at pin 9 is the same as Throttle Positive (T+), the maximum speed of the scooter at 100% throttle deflection is not limited and is as set by the **Maximum Forward Speed** (4.4.3.1) and **Maximum Reverse Speed** (4.4.3.4) parameters.

If the voltage at pin 9 is the same as Throttle Negative (T-), the maximum speed of the scooter at 100% throttle deflection is scaled down to **Lowest Forward Speed** (4.4.3.7) and **Lowest Reverse Speed** (4.4.3.8).

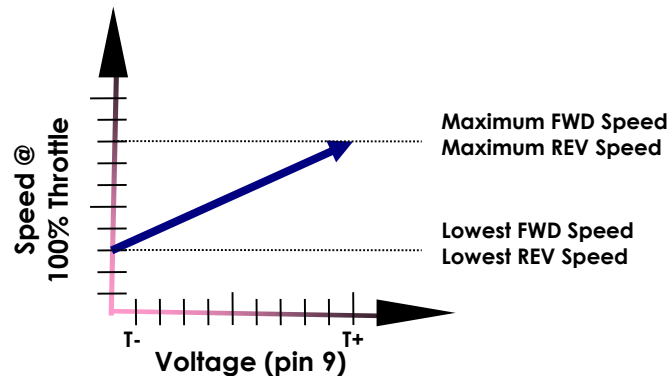

The throttle output is scaled down, not limited, so the throttle does not have a dead band when the speed pot is at a low setting.

4.4.2.12 Slam Brake

Parameter	Possible Values	Default	HHP	Lite	Std	Adv
Slam Brake Enable	No / Yes	No				✓
Slam Brake Threshold	0 - 100 %	0 %				✓

Slam Brake Enable turns on slam braking in the forward and reverse direction*.

Slam Braking is applied when the throttle is significantly moved in the opposite direction to the direction that the scooter is currently moving in (the minimum amount of throttle movement in the opposite direction is set with **Slam Brake Threshold**)

During a slam brake, the scooter decelerates with the rate that is set with the **Slam Braking** parameter (4.4.3.12). Be careful when enabling slam braking because this setting may not be suitable for all scooter types.



Note:

With R-series controllers before software version 1.26 (DR50-A01 before s/n B09175730, DR50-B01 before s/n A09150168 and DR90-A01 before s/n B09201834) it is not possible to turn off slam braking in the forward direction. For these units **Slam Brake Enable only applies to the reverse direction, the forward direction is always enabled. **Slam Brake Enable** was previously called **Slam Brake Reverse**.*

4.4.2.13 Broken Wiper Wire Detection.

Parameter	Possible Values	Default	HHP	Lite	Std	Adv
Broken Wiper Wire Test	No / Yes	No				✓
Broken Wiper Wire Accuracy	0 - 15	0				✓

Broken Wiper Wire Test turns on broken wiper wire testing for wig-wag type throttles.

Broken Wiper Wire Accuracy is used to decrease the likelihood of false faults in a noisy environment. Higher values make testing less sensitive to noise, but increases the response time. Every increase by 1 extends detection time by 20ms.

If the wiper wire breaks during driving, the controller will interpret that as a neutral signal and will slow the scooter to a stop using normal deceleration.

Once the scooter has stopped, the controller will test for a broken wiper wire, if enabled using parameter Broken Wiper Wire Test. The controller will signal a broken wiper wire to the user with a flash code.

Turning this feature off does not impact safety, because the scooter will be stopped and will not drive any more if the wiper wire is broken. Its function is to make the user aware that there is a problem with the throttle.

4.4.3 Drive Performance

The R-series has 2 Drive Profiles that are typically used for

- Drive Profile 1 - Normal Drive
- Drive Profile 2 - A 'Slow Speed' mode for indoor use that the user can select with a 'Slow' switch. The indoor profile can limit the speed as well as the acceleration.

Normally Drive Profile 1 is always selected. Drive Profile 2 is only used when **Pin [X] Function** (4.4.9.1) is set to 'Profile 2' and the associated input pin is activated.

4.4.3.1 Maximum Forward Speed

Parameter	Possible Values	Default	HHP	Lite	Std	Adv
Maximum Forward Speed	20 - 100 %	60 %	✓	✓	✓	✓

Sets the maximum speed in the forward direction when the highest speed has been selected with the speed limit pot (see 3.7.6) and the throttle is fully deflected forward. Dealers can adjust this parameter to the preference of an individual user or to the terrain that a specific scooter will be used in.



Note:

This parameter cannot be set higher than the value of the **Maximum Forward Speed Limit** parameter (4.4.4.1) that has been set by the scooter manufacturer.

4.4.3.2 Forward Acceleration

Parameter	Possible Values	Default	HHP	Lite	Std	Adv
Forward Acceleration	0 - 100 %	40 %	✓	✓	✓	✓

Sets how quickly the forward speed increases after the throttle has been deflected forward.

- 0 %** - From standstill, the scooter reaches full forward speed in 10 s
100 % - From standstill, the scooter reaches full forward speed in 0.4 s

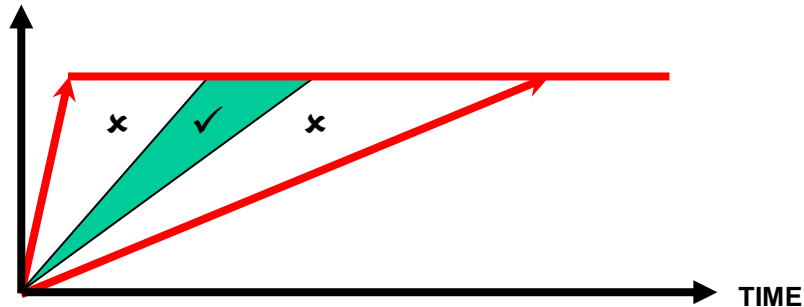

Low acceleration values give a softer performance and a less sensitive throttle response. High acceleration values give a more aggressive performance and a fast throttle response.



Note:

This parameter cannot be set higher than the value of the **Acceleration Limit** parameter (4.4.4.5) that has been set by the scooter manufacturer.

SPEED

Too high

- Too sensitive
- Jerky

Good

- Smooth
- Dependent on user and environment

Too low

- Unresponsive
- Long delays

4.4.3.3 Forward Deceleration

Parameter	Possible Values	Default	HHP	Lite	Std	Adv
Forward Deceleration	0 - 100 %	60 %	✓	✓	✓	✓

Sets how quickly the scooter slows down after the throttle has been released to neutral.

- 0 %** - From full forward speed, the scooter stops in 10 s
100 % - From full forward speed, the scooter stops in 0.4 s

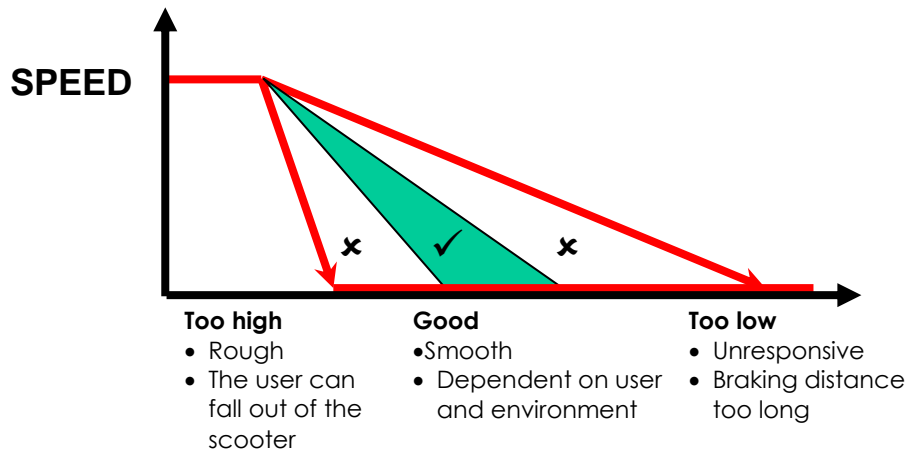

Low deceleration values produce a gentle stop, but increase the braking distance. High deceleration values produce a more aggressive stop, but can be uncomfortable. Adjust this parameter to the preference of the user.

**Note:**

This parameter cannot be set higher than the value of the **Deceleration Limit** parameter (4.4.4.6) that has been set by the scooter manufacturer.

**Warning:**

Setting **Forward Deceleration** too low or too high can result in a scooter that is unsafe. Test thoroughly after programming to make sure that the scooter complies with local regulatory requirements for maximum allowable braking distance.

4.4.3.4 Maximum Reverse Speed

Parameter	Possible Values	Default	HHP	Lite	Std	Adv
Maximum Reverse Speed	20 - 100 %	40 %	✓	✓	✓	✓

Sets the maximum speed in the reverse direction when the highest speed has been selected with the speed limit pot (see 3.7.6) and the throttle is fully deflected reverse. Dealers can adjust this parameter to the preference of an individual user or to the terrain that a specific scooter will be used in.



Note:

*This parameter cannot be set higher than the value of the **Maximum Reverse Speed Limit** parameter (4.4.4.2) that has been set by the scooter manufacturer.*

4.4.3.5 Reverse Acceleration

Parameter	Possible Values	Default	HHP	Lite	Std	Adv
Reverse Acceleration	0 - 100 %	25 %	✓	✓	✓	✓

Sets how quickly the reverse speed increases after the throttle has been deflected reverse.

- 0 %** - From standstill, the scooter reaches full reverse speed in 10 s
- 100 %** - From standstill, the scooter reaches full reverse speed in 0.4 s

Low acceleration values give a softer performance and a less sensitive throttle response. High acceleration values give a more aggressive performance and a fast throttle response.



Note:

*This parameter cannot be set higher than the value of the **Acceleration Limit** parameter (4.4.4.5) that has been set by the scooter manufacturer.*

4.4.3.6 Reverse Deceleration

Parameter	Possible Values	Default	HHP	Lite	Std	Adv
Reverse Deceleration	0 - 100 %	40 %	✓	✓	✓	✓

Sets how quickly the scooter slows down after the throttle has been released to neutral while driving reverse.

0 % - From full reverse speed, the scooter stops in 10 s

100 % - From full reverse speed, the scooter stops in 0.4 s

Low deceleration values produce a gentle stop, but increase the braking distance. High deceleration values produce a more aggressive stop, but can be uncomfortable. Adjust this parameter to the preference of the user.



Note:

This parameter cannot be set higher than the value of the **Deceleration Limit** parameter (4.4.4.6) that has been set by the scooter manufacturer.



Warning:

Setting **Reverse Deceleration** too low or too high can result in a scooter that is unsafe. Test thoroughly after programming to make sure that the scooter complies with local regulatory requirements for maximum allowable braking distance.

4.4.3.7 Lowest Forward Speed

Parameter	Possible Values	Default	HHP	Lite	Std	Adv
Lowest Forward Speed	0 - 100 %	20 %	✓	✓	✓	✓

This parameter is only used when **Speed Limit Pot** (4.4.2.11) is set to 'Yes'.

Lowest Forward Speed sets the maximum speed in the forward direction when the lowest speed has been selected with the speed limit pot (see 3.7.6) and the throttle is fully deflected forward. Dealers can adjust this parameter to the preference of an individual user or to the terrain that a specific scooter will be used in.



Note:

*This parameter is used with a speed limit pot that is connected IN PARALLEL with the throttle, between 'Throttle Positive' (pin 2) and 'Throttle Negative' (pin 8), and that has its wiper connected to pin 9 (speed limit pot input). If the scooter has a speed limit pot that is connected IN SERIES with the throttle wiper, **Lowest Forward Speed** is not used and **Speed Limit Pot** must be set to 'No'.*

*This parameter cannot be set lower than the value of the **Lowest Forward Speed Limit** parameter (4.4.4.3) that has been set by the scooter manufacturer.*

4.4.3.8 Lowest Reverse Speed

Parameter	Possible Values	Default	HHP	Lite	Std	Adv
Lowest Reverse Speed	0 - 60 %	10 %	✓	✓	✓	✓

This parameter is only used when **Speed Limit Pot** (4.4.2.11) is set to 'Yes'.

Sets the maximum speed in the reverse direction when the lowest speed has been selected with the speed limit pot (see 3.7.6) and the throttle is fully deflected reverse. Dealers can adjust this parameter to the preference of an individual user or to the terrain that a specific scooter will be used in.



Note:

*This parameter cannot be set lower than the value of the **Lowest Reverse Speed Limit** parameter (4.4.4.4) that has been set by the scooter manufacturer.*

4.4.3.9 Soft Start Period

Parameter	Possible Values	Default	HHP	Lite	Std	Adv
Soft Start Period	0 - 2550 ms	1000 ms	✓*		✓	✓

When the scooter starts to drive from a standstill, the soft start function temporarily reduces the acceleration rate during the time that is set with **Soft Start Period**. This makes the acceleration smoother, especially with high acceleration rates or high load compensation settings.

Higher values give a softer start, while lower values give a more direct and harsh start.

To disable soft start completely, set **Soft Start Period** to zero.

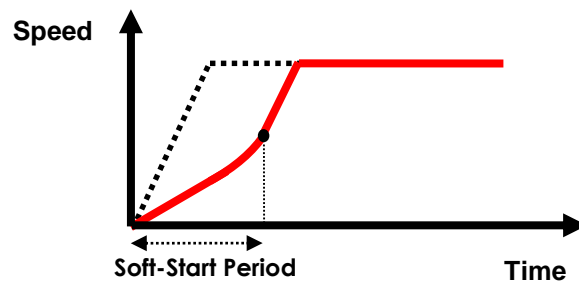

4.4.3.10 Soft Finish

Parameter	Possible Values	Default	HHP	Lite	Std	Adv
Soft Finish	0 - 100 %	40 %	✓*		✓	✓

When the scooter almost reaches its desired speed during acceleration or deceleration, the acceleration/deceleration rate is slowly decreased to zero. This prevents a sudden change in acceleration once the desired speed is reached.

Use the **Soft Finish** parameter to adjust the point where the soft transition starts.

0 %: Direct and harsh transition (no soft finish at all)

100 %: Very smooth transition

For most applications, the default value of 40 % works fine.

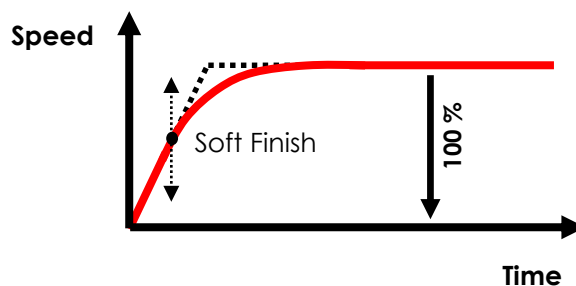

4.4.3.11 Emergency Deceleration

Parameter	Possible Values	Default	HHP	Lite	Std	Adv
Emergency Deceleration	0 - 100 %	80 %				✓

Emergency Deceleration sets how quickly the scooter comes to a halt when

- a Stop input is active
- a fault that requires an emergency stop occurs
- the key switch is removed while driving

If the normal deceleration rate is higher than **Emergency Deceleration**, the normal deceleration value is used.

Emergency deceleration rate is only used when travelling forward. When travelling reverse, normal deceleration is used. This is to avoid tipping backwards when backing on a slope.



Warning:

If this parameter is set too high, the user can fall out of the scooter during an emergency stop.

4.4.3.12 Slam Braking

Parameter	Possible Values	Default	HHP	Lite	Std	Adv
Slam Braking	0 - 100 %	100 %				✓

Slam Braking sets how quickly the scooter comes to a halt when the throttle is moved significantly in the opposite direction to the direction that the scooter is currently moving in.

If the normal deceleration rate is higher than Slam Braking, the normal deceleration value is used.



Warning:

If this parameter is set too high, the user can fall out of the scooter during a slam braking operation.

4.4.3.13 Push Speed

Parameter	Possible Values	Default	HHP	Lite	Std	Adv
Push Speed	15 - 100 %	40 %				✓

This feature will stop the scooter from rolling away on a slope when the *controller is on* and the park brakes have been released electrically (this would normally be the case if the scooter is being pushed).

If the scooter is being pushed (by an external force) at a higher speed than **Push Speed**, the controller will limit the speed to **Push Speed**.



Note:

To release the park brakes electrically, set one of the multi-function input pin parameters (see 4.4.9) to 'Release Brake'.

4.4.3.14 Roll-away Speed

Parameter	Possible Values	Default	HHP	Lite	Std	Adv
Roll-away Speed	30 - 100 %	40 %				✓

This feature will stop the scooter from rolling away on a slope when the *controller is off* and the park brakes have been released manually.

If the scooter moves at a higher speed than **Roll-away Speed**, the controller will turn on by itself and reduce the speed of the scooter to a safe level.



Warning:

If this parameter is set too high, especially with heavier scooters, there is a risk of injury, through collision or crushing, when the scooter rolls down a slope.



Note:

If the batteries are not connected, the controller uses the power that is generated by the motors during a rollaway to power itself on. In this case the controller will also limit the speed to a safe level.



Warnings:

- 1) After the scooter has stopped successfully, apply the park brake before turning on the scooter. During the 2-second boot process the scooter is not controlled. In these 2 seconds, the scooter will start to roll again before it will come to an abrupt halt when the R-series has completed the boot process.
- 2) If the batteries are not connected and the scooter is rolling away at some speed, the anti-rollaway feature may cause sudden braking so that it can reduce the speed of the scooter quickly; this may be upsetting and / or dangerous for the occupant.

4.4.3.15 Speed Reduction Wiper (SRW) parameters

Parameter	Possible Values	Default	HHP	Lite	Std	Adv
SRW Forward Speed Limit	0 - 100 %	50 %			✓	✓
SRW Reverse Speed Limit	0 - 100 %	50 %			✓	✓
SRW Forward Speed Scale	0 - 100 %	50 %			✓	✓
SRW Reverse Speed Scale	0 - 100 %	50 %			✓	✓

These parameters are only used when **Pin 4 Function** (0) is set to 'SRW'

If **Pin 4 Function** is set to 'SRW', the R-series reduces the speed proportionally to the resistance between pin 4 of the tiller head connector and battery negative (B-). If the resistance is 10k Ω or more, the speed is not reduced. If the resistance is zero, the speed is reduced to the value of any of the four **SRW Speed** parameters.

For more information on Speed Reduction Wiper connections, see section 3.7.7.

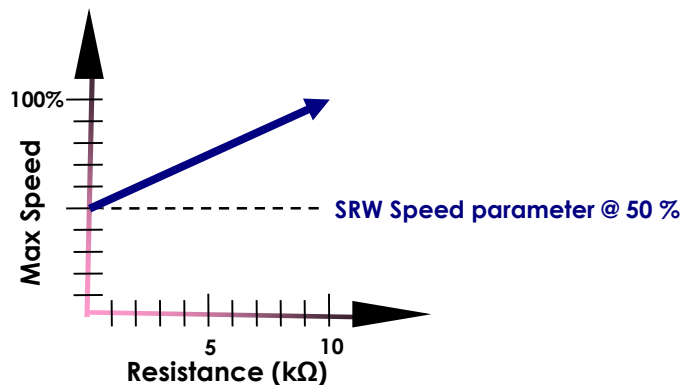

The speed can be reduced in 2 different ways:

- Limit** - Limits the speed of the scooter itself. This means that the throttle can still ask for 100% speed, but when the scooter reaches the **SRW Speed Limit** value, the actual speed will not increase any further. This creates a dead band in throttle operation. However, below the speed limit the behaviour of the throttle does not change.
- Scale** - Scales the throttle output. This means that if **SRW Speed Scale** is set to 50%, the throttle will only ask for 50% speed at full deflection. This does not create a throttle dead band. However, it changes the behaviour of the throttle over the full range of deflection.

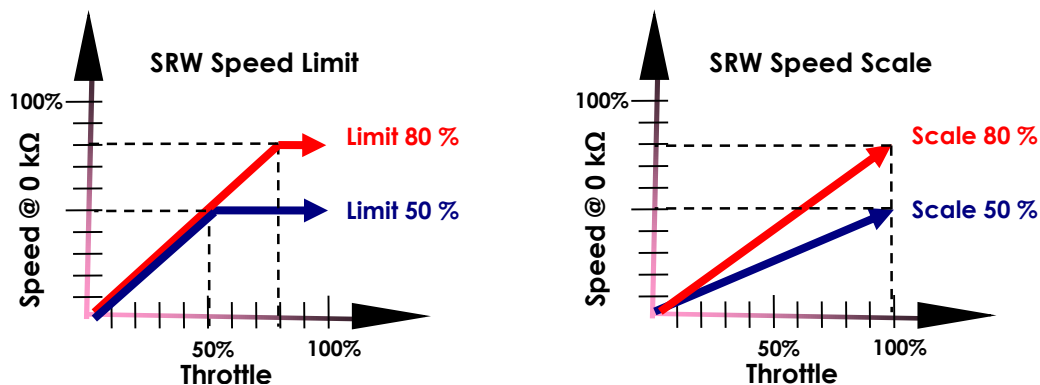

All 4 parameters reduce the speed simultaneously and independently of each other. If any of the parameters is set to 100%, it disables the reduction effect of that specific parameter.

4.4.4 OEM Drive Limits

The OEM Drive Limits allow the OEM to set the maximum value that dealers can set several drive performance parameters to. This allows OEMs to limit certain parameters for specific scooter models. Dealers will not be able to set the value of these parameters higher or lower than the limits given below.

4.4.4.1 Maximum Forward Speed Limit

Parameter	Possible Values	Default	HHP	Lite	Std	Adv
Maximum Forward Speed Limit	0 - 100 %	100 %			✓	✓

Sets the maximum value that can be set by a dealer for the **Maximum Forward Speed** parameter (4.4.3.1). Set to 100 % for no effect.

4.4.4.2 Maximum Reverse Speed Limit

Parameter	Possible Values	Default	HHP	Lite	Std	Adv
Maximum Reverse Speed Limit	0 - 100 %	100 %			✓	✓

Sets the maximum value that can be set by a dealer for the **Maximum Reverse Speed** parameter (4.4.3.4). Set to 100 % for no effect.

4.4.4.3 Lowest Forward Speed Limit

Parameter	Possible Values	Default	HHP	Lite	Std	Adv
Lowest Forward Speed Limit	0 - 10 %	0 %			✓	✓

Sets the minimum value that can be set by a dealer for the **Lowest Forward Speed** parameter (4.4.3.7). Set to 0 % for no effect.

4.4.4.4 Lowest Reverse Speed Limit

Parameter	Possible Values	Default	HHP	Lite	Std	Adv
Lowest Reverse Speed Limit	0 - 100 %	0 %			✓	✓

Sets the minimum value that can be set by a dealer for the **Lowest Reverse Speed** parameter (4.4.3.8). Set to 0 % for no effect.

4.4.4.5 Acceleration Limit

Parameter	Possible Values	Default	HHP	Lite	Std	Adv
Acceleration Limit	0 - 100 %	100 %			✓	✓

Sets the maximum value that can be set by a dealer for the **Forward Acceleration** (4.4.3.2) and **Reverse Acceleration** (4.4.3.5) parameters. Set to 100 for no effect.

4.4.4.6 Deceleration Limit

Parameter	Possible Values	Default	HHP	Lite	Std	Adv
Deceleration Limit	0 - 100 %	100 %			✓	✓

Sets the maximum value that can be set by a dealer for the **Forward Deceleration** (4.4.3.3) and **Reverse Deceleration** (4.4.3.6) parameters. Set to 100 for no effect.

4.4.5 Motor Management

4.4.5.1 Motor Protection

Parameter	Possible Values	Default	HHP	Lite	Std	Adv
Motor Protection	No / Yes	No				✓

Motor Protection is a function that calculates the approximate temperature of the motor by measuring the motor current over time. If the calculated motor temperature becomes too high, the current output of the R-series is reduced to protect the motor from burning out.

In R-series software revision C, a new algorithm was introduced that is easier to set up than the old algorithm. The new algorithm uses different parameters with a different name. The parameters of the two versions are described in two different sections on this and the following page.



Note:

This function assists in motor protection. However, it cannot completely prevent the motor from burning out. The motor may last longer, but specific conditions can still burn out a motor, even with Motor Protection activated.

The motor protection function operates in parallel with other current control functions and so the actual current limit will be determined by whichever process requests the lowest operating current.

4.4.5.2 Motor Protection Parameters (Rev. C,D and E)

Parameter	Possible Values	Default	HHP	Lite	Std	Adv
Motor Continuous Current	0 - 255 A	12 A (DR50) 15 A (DR90)				✓
Motor Heating Time	0 - 255 s	20 s				✓
Motor Cooling Time	0 - 1020 s	32 s				✓

These parameters are only used if **Motor Protection** is set to 'Yes'.

Adapt these parameters to match the motor that is fitted on the scooter. See the motor specifications given by the motor manufacturer for the correct values.

Motor Continuous Current is the current at which the motor can run continuously without becoming too hot.

Motor Heating Time is the time that the motor can run at the programmed **Current Limit** (4.4.5.9) before it becomes too hot. If the motor current has been close to **Current Limit** for **Motor Heating Time** seconds, the current is limited to **Motor Continuous Current** so the motor can cool down.

Before the current can reach the **Current Limit** value again, the motor current must stay below the value of **Motor Continuous Current** for **Motor Cooling Time** seconds.



Note:

*The time before the motor protection current limit is activated depends on the actual motor current. **Motor Heating Time** is the time that the motor can take the full **Current Limit** current before it becomes too hot. If the actual motor current is above **Motor Continuous Current** but much lower than **Current Limit**, the time before the motor protection limit is activated is longer.*

4.4.5.3 Motor Protection Parameters (Rev. A and B)

Parameter	Possible Values	Default	HHP	Lite	Std	Adv
Motor Continuous Current	0 - 255 A	12 A (DR50) 15 A (DR90)				✓
Motor Case Time	0 - 87 min	20 min				✓
Motor Brush Time	0 - 326 s	20 s				✓
Motor Brush/Case Ratio	0 - 100 %	30 %				✓

These parameters are only used if **Motor Protection** is set to 'Yes'.

Adapt these parameters to match the motor that is fitted on the scooter. See the motor specifications given by the motor manufacturer for the correct values.

Motor Continuous Current is the current at which the motor can run continuously without becoming too hot.

Motor Brush Time / Motor Case Time. The algorithm estimates the temperature of both the motor brush assembly and the motor case. A heating term and a cooling term are calculated for the motor brush assembly. This calculation updates at intervals proportional to **Motor Brush Time**. A heating term and a cooling term are also calculated for the motor case. This calculation updates more slowly, at intervals proportional to **Motor Case Time**.

Motor Brush/Case Ratio specifies what fraction the motor case temperature rises compared to the brush temperature. This Ratio term will be used to multiply the case heating term, and the complement of the Ratio will be used to multiply the case cooling term. Thus a Ratio of 66% will cause the estimated case temperature to stabilise at two-thirds of the estimated brush temperature, while a Ratio of 25% will cause the estimated case temperature to stabilise at 1/4 of the estimated brush temperature. The Ratio term will also be used to scale the brush cooling term, but the actual multiplier will be $(1/(1-\text{Ratio}))$. Therefore the higher the Ratio value, the smaller the difference between brush and case temperatures for a given amount of brush cooling.

4.4.5.4 Motor Reverse

Parameter	Possible Values	Default	HHP	Lite	Std	Adv
Motor Reverse	No / Yes	No			✓	✓

Yes - The polarity of the motor pins on the R-series is reversed and the motor turns in the opposite direction.

No - The polarity of the motor pins is as described in section 3.3.



Note:

Do not use **Motor Reverse** to setup the scooter for left-handed use, set the **Swap Throttle Direction** parameter (see 4.4.1.3) to 'Yes' instead. **Motor Reverse** only swaps the motor polarity, not other forward/reverse features such as the Forward/Reverse speed setting and the reversing beeper. Using **Motor Reverse** to setup the scooter for left-handed use will result in the reversing beeper beeping while the scooter drives slowly forward.

4.4.5.5 **Load Compensation**

Parameter	Possible Values	Default	HHP	Lite	Std	Adv
Load Compensation	0 - 1020 mΩ	100 mΩ	✓*		✓	✓

Load Compensation automatically compensates for changes in motor speed when the scooter drives over loads such as sidewalks, curbs or slopes.



Note:

The **Load Compensation** parameter affects the performance of all other speed and acceleration parameters, and it is important to set **Load Compensation** correctly **before you program these parameters**. If the **Load Compensation** parameter is changed after the scooter has been set up, the complete speed/acceleration programming and testing procedure must be repeated.

Set **Load Compensation** to the resistance of the motor that is installed on the scooter.

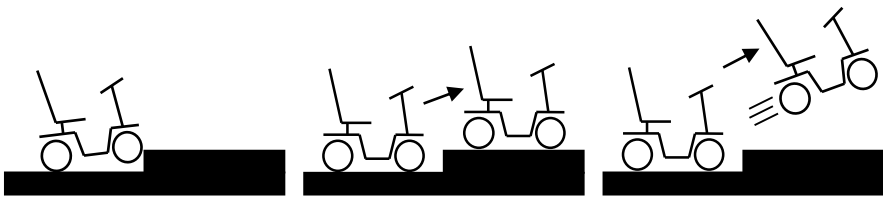
Motor Resistance	Too low	Correct	Too high
Scooter behaviour	<ul style="list-style-type: none"> • Drives like it is going through thick mud • Slows down when it goes up a sidewalk edge or up a ramp • Slows down with heavier users • Rolls back significantly after stopping on a slope 	<ul style="list-style-type: none"> • Drives smoothly • Keeps the speed reasonably constant. Only slightly slows down on a slope • Does not roll back after stopping on a slope 	<ul style="list-style-type: none"> • Drives very rough • Hard to control, vibrates or surges • May creep forward after stopping on a slope • Motor becomes hotter than normal very easily, decreased motor life
			

If the scooter gives poor performance on carpet or at low speeds, the most probable cause is a **Load Compensation** value that is set too low.

Determining the correct motor resistance by looking at the scooter behaviour

Tools needed

1. A scooter with an R-series controller fitted
2. A Hand Held Programmer (HHP) or a laptop with the Wizard Programmer
3. A slope that you can drive up to

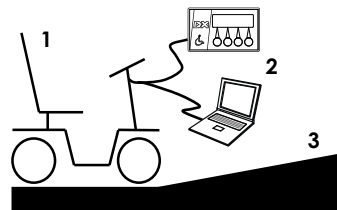

Procedure

- Set **Load Compensation** to 20.
- Drive the scooter onto a slope and increase the **Load Compensation** value until the scooter does not roll back after it has stopped on the slope.

To test if **Load Compensation** has the correct value, perform a series of scooter tests (drive on a slope, up a sidewalk edge, and over thick carpet) and check if the scooter behaviour is similar to the correct behaviour described above.

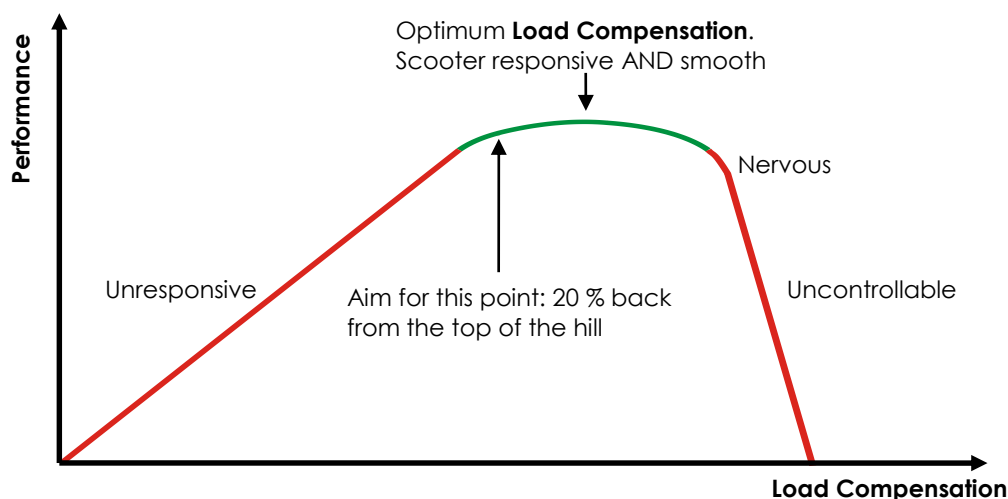

Notes:

1. This test procedure causes the motor to become hot. For this reason, the resulting value for **Load Compensation** is too high. Reduce **Load Compensation** by 20% to make sure that the scooter is still comfortable to drive when the motor is cold.
2. A new motor usually has a higher motor resistance than a motor that has been used for some time, because the motor brushes that are inside the motor do not make optimal contact until they are "worn in". If possible, perform this procedure when the motor has been used for several hours.

4.4.5.6 Maximum Load Compensation

Parameter	Possible Values	Default	HHP	Lite	Std	Adv
Maximum Load Compensation	0 - 1020 mΩ	1000 mΩ				✓

This parameter sets the maximum value that the **Load Compensation** parameter can be set to. This value must be set by the OEM to match the motors of the powerchair.

Maximum Load Compensation prevents the dealer from setting **Load Compensation** to a value that is too high, which can be dangerous.

4.4.5.7 Load Compensation Damping

Parameter	Possible Values	Default	HHP	Lite	Std	Adv
Load Compensation Damping	0 - 60%	50%				✓

Load Compensation Damping is used to dampen the effects of the load compensation to avoid bucking and instability at high **Load Compensation** settings. Bucking is characterised as a rocking or lurching motion when coming to a halt or jerky and unsteady acceleration when starting from a stop (usually occurring under low throttle application).

The recommended value for this parameter is between 25 – 50%. It's important to avoid higher values of **Load Compensation Damping** as this can lead to the load compensation continuing to be applied when the motor current has fallen, causing problems such as the scooter continuing to surge forward after, for example, climbing an obstacle.

The **Load Compensation Damping** parameter interacts with the following parameters:

- **Remembered Load Compensation**
- **Load Compensation**
- **Park Brake Neutral Delay**

When setting these parameters, follow the method below:

1. Adjust the **Load Compensation** parameter first to give correct driving performance.
2. Adjust **Load Compensation Damping** to minimise bucking, while keeping the system responsive.
3. Adjust the **Park Brake Neutral Delay** parameter to provide acceptable rollback on slopes and prevent jerking – higher values decrease jerking but give more rollback and vice versa.
4. Adjust the **Remembered Load Compensation** to give acceptable starting performance when the park brakes are released, both when driving on the flat and on slopes. (Note: this parameter has no effect if the scooter stops and restarts driving quickly such that the park brakes are never applied.)

4.4.5.8 Remembered Load Compensation

Parameter	Possible Values	Default	HHP	Lite	Std	Adv
Remembered Load Compensation	0 - 60%	50%				✓

The controller records the amount of motor current that is required to hold the scooter stationary just before the park brakes are applied. When the scooter starts off again, this recorded value is used to calculate the starting load compensation value to reduce the amount that the scooter rolls back. The **Remembered Load Compensation** parameter adjusts the amount of this starting load compensation.

The **Remembered Load Compensation** parameter interacts with the following parameters:

- **Load Compensation Damping**
- **Load Compensation**
- **Park Brake Neutral Delay**

When setting these parameters, follow the method below:

1. Adjust the **Load Compensation** parameter first to give correct driving performance.



2. Adjust **Load Compensation Damping** to minimise bucking, while keeping the system responsive.
3. Adjust the **Park Brake Neutral Delay** parameter to provide acceptable rollback on slopes and prevent jerking - higher values decrease jerking but give more rollback and vice versa.
4. Adjust the **Remembered Load Compensation** to give acceptable starting performance when the park brakes are released, both when driving on the flat and on slopes. (Note: this parameter has no effect if the scooter stops and restarts driving quickly such that the park brakes are never applied.)

4.4.5.9 Current Limit

Parameter	Possible Values	Default	HHP	Lite	Std	Adv
Current Limit	0 - 40 A (DR50) 0 - 70 A (DR90)	40 A			✓	✓

Current Limit sets the maximum output current in Ampere that the R-series will deliver to a motor. A low value can affect the performance of the scooter, for example when the scooter tries to climb up a curb.

The maximum useable setting depends on the current rating for the controller type, for example 40A for the DR50. Higher settings have no effect on the controller.

	<p>Warning:</p> <p><i>Do not set this parameter too high for the type of motor used.</i></p>
	<p>Notes:</p> <p><i>The time that the R-series will deliver the maximum sustained current to the motors is limited by the Stall Timeout parameter (4.4.5.11).</i></p> <p><i>To protect the electronics of the R-series, the maximum current will be reduced further if the controller becomes too hot.</i></p>

4.4.5.10 Boost Current / Boost Time

Parameter	Possible Values	Default	HHP	Lite	Std	Adv
Boost Current	0 - 10 A (DR50) 0 - 20 A (DR90)	8 A			✓	✓
Boost Time	0 - 51 s	4 s			✓	✓

The R-series can deliver an additional current of **Boost Current** Ampere for **Boost Time** seconds, to overcome transient loads such as starting on a hill, overcoming castor lock, climbing obstacles, etc.

If the **Boost Time** is reached, the current is limited to **Current Limit**.

Before the current can reach the **Boost Current** value again, the motor current must stay below the value of Current Limit for at least twice as long as that it has been above Current Limit.

4.4.5.11 Stall Timeout

Parameter	Possible Values	Default	HHP	Lite	Std	Adv
Stall Timeout	0 - 51 s	25 s				✓

If the throttle is deflected but the scooter cannot drive because

- It is on a slope that is too steep,
- It tries to climb up a curb that is too high, or
- It is trapped,

the maximum current (as set by the **Current Limit** parameter) will flow through the motor continuously, because the motor is still trying to drive. This situation is called motor stalling.

Motor stalling can cause motor damage when the motor becomes too hot. To prevent motor damage, the R-series disables drive after **Stall Timeout** seconds of maximum continuous current.

If a stall timeout has occurred, the scooter will perform an emergency stop and the Status LED shows Flash Code 4 (see section 5.2 for flash code descriptions). The scooter does not drive. To reset the fault, turn the scooter off and turn it back on again.



Notes:

*Some safety standards specify a particular stall timeout. See the regulations of the country in which the scooter is to be used to determine what the correct **Stall Timeout** value is.*

If Stall Timeout is set to zero, the R-series will deliver as much power as it can, for as long as it can, while still protecting itself. This is not recommended because it can be against local regulations and can cause motor damage.

4.4.5.12 Motor Testing

Parameter	Possible Values	Default	HHP	Lite	Std	Adv
Motor Testing	None Open Short All	Short				✓

Before and during driving, the motors are tested to make sure that they are OK. This parameter controls the tests that are done before driving.

- All** - Test the motor for both open and short circuits.
Always use this setting unless one of the conditions below applies.
- Open** - Test the motor for open circuits.
Use this setting if low-impedance motors are being detected as a short circuit.
- Short** - Test the motor for short circuits.
Use this setting if the open circuit test is noisy, or if the system wiring is not compatible.
- None** - Disable all motor testing.



Warning:

For safety reasons, do not set this parameter to 'None' unless for testing in a controlled environment.

Only set this parameter to 'Open' or 'Short' if the motors used are failing the test and they have been fully tested to make sure that they are healthy.

4.4.5.13 Maximum Motor Voltage

Parameter	Possible Values	Default	HHP	Lite	Std	Adv
Maximum Motor Voltage	2 – 40.2 V	28.8 V				✓

Maximum Motor Voltage sets the maximum voltage that the R-series will apply to the motor.



Note:

If local regulations require that the scooter speed is limited to a specific value, use this parameter to set a speed limit for a particular scooter type (for specific motors and a specific wheel diameter).

If the momentary battery voltage is less than the programmed **Maximum Motor Voltage** value (for example when the battery is almost empty), then the battery voltage itself is the maximum applied voltage at 100 % speed demand.

The actual voltage output from the R-series may at times be up to 10 V higher than this setting due to **Load Compensation** (4.4.5.5).

4.4.5.14 Dead-time Adjust

Parameter	Possible Values	Default	HHP	Lite	Std	Adv
Deadtime Adjust	0-4	0				✓

The **Dead-time Adjust** value affects the way the H-Bridge is controlled. When the controller is calibrated during manufacture, the dead-time of the H-Bridge FETs is set to its most efficient value. On some scooters this can lead to slightly elevated EMC emission levels.

If the **Dead-time Adjust** value is set to zero, then the controller uses the factory calibration value.

If the **Dead-time Adjust** value is incremented beyond zero, then the H-bridge will be driven in a slightly less efficient way, resulting in a minor loss of performance (power delivered to the motor) with a maximum loss of around 1%.

Most scooters will show a slight drop in EMC emission levels if the Dead-Time Adjust value is incremented. Set this parameter as low as possible.

4.4.6 Park brake Management

4.4.6.1 Park brake Testing

Parameter	Possible Values	Default	HHP	Lite	Std	Adv
Park brake Testing	None Pre-drive Driving	Pre-drive				✓

- Driving** - The R-series checks the park brake for open-circuit faults before and during driving.
- Pre-drive** - The R-series checks the park brake for open circuit faults before driving, but not during driving. Use this option when the open circuit test during driving is very noisy and/or incorrect faults are generated.
- None** - The R-series never checks the park brake for open circuit faults. This option allows the R-series to be used without an electric park brake.

Regardless of the option selected, the R-series checks the park brake for short circuit faults immediately before and periodically during driving.



Warning:

For safety reasons, do not use 'None' if the scooter has an electric park brake.

4.4.6.2 Park brake Neutral Delay

Parameter	Possible Values	Default	HHP	Lite	Std	Adv
Park brake Neutral Delay	0 - 25500 ms	2000 ms			✓	✓

The **Park brake Neutral Delay** parameter sets the delay between zero speed demand (after the scooter has decelerated and stopped) and the moment that the park brakes are engaged.

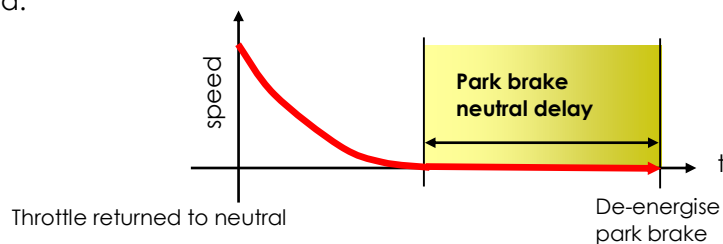

The correct value of this parameter is dependent on the mechanics of the park brake that is used on the scooter. The delay must be longer for fast acting park brakes.

If the value of **Park brake Delay** is set too high, there may be too much rollback when stopping on a slope. If the value is set too low, the scooter may stop too abruptly.

4.4.6.3 Park Brake Release Delay

Parameter	Possible Values	Default	HHP	Lite	Std	Adv
Park Brake Release Delay	0 - 25500 ms	0 ms			✓	✓

The **Park Brake Release Delay** is the interval between when the park brake is released and when the scooter starts driving.

When the scooter is stopped, and the throttle is deflected, the park brake is released immediately but the scooter will not start driving until the **Park Brake Release Delay** has expired. This is useful for park brakes that have a slow mechanical release.

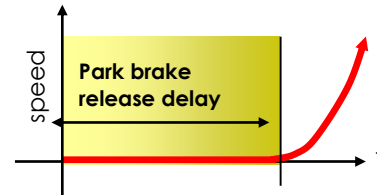

Throttle deflected &
Park brake energised

Set the **Park Brake Release Delay** to suit the mechanical release speed of the park brake: set the value high for slow releases, and low or zero for fast releases.



Warning:

If the **Park Brake Release Delay** value is set too high the scooter may begin rolling before the motors start driving.

4.4.7 Battery Management

4.4.7.1 Overvoltage Rollback

Parameter	Possible Values	Default	HHP	Lite	Std	Adv
Overvoltage Warning	24 - 30.2V	30.2V				✓
Overvoltage Rollback	30.2 – 34.8V	34.2V				✓

Set **Overvoltage Warning** to the voltage at which the controller will **begin slowing** the scooter to protect the batteries from an over-voltage condition.

Set **Overvoltage Rollback** to the voltage at which the controller will **stop** driving the scooter to protect the batteries from an over-voltage condition.

4.4.7.2 Undervoltage Rollback

Parameter	Possible Values	Default	HHP	Lite	Std	Adv
Undervoltage Rollback Start	18 - 32.2 V	21 V				✓
Undervoltage Rollback End	17 - 21 V	18 V				✓

If the battery Voltage falls below **Undervoltage Rollback Start**, the R-series reduces the

maximum throttle input value, so the user cannot ask for full speed anymore. This

- protects the battery
- gives the scooter a longer range before the battery is completely empty
- gives the user a physical warning that the battery is almost empty before the battery is damaged.

The scooter will drive slower but should still be able to climb small obstacles such as curbs. If the battery voltage falls below **Undervoltage Rollback End**, the scooter stops driving because the throttle is reduced to zero.

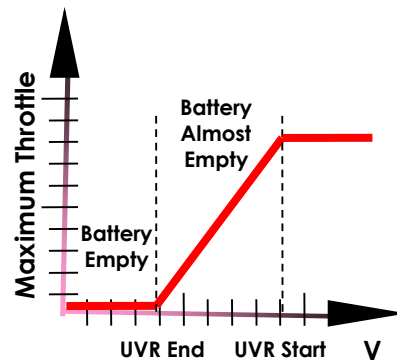

4.4.7.3 Battery Gauge Minimum/Maximum

Parameter	Possible Values	Default	HHP	Lite	Std	Adv
Battery Gauge Minimum	16 - 24 V	22 V				✓
Battery Gauge Maximum	19 - 27 V	24.4 V				✓

Battery Gauge Minimum - sets the voltage at which the Battery gauge indicates an empty battery.

Battery Gauge Maximum - sets the voltage at which the Battery gauge indicates a full battery.

4.4.7.4 Battery Gauge Warning

Parameter	Possible Values	Default	HHP	Lite	Std	Adv
Battery Gauge High Warning	24 - 32 V	29 V			✓	✓
Battery Gauge Low Warning	18 - 26 V	23.4 V			✓	✓

Battery Gauge High Warning - sets the voltage at which a high-voltage condition is indicated.

Battery Gauge Low Warning - sets the voltage at which a low-voltage condition is indicated.

4.4.7.5 Battery Cut-Off Voltage

Parameter	Possible Values	Default	HHP	Lite	Std	Adv
Battery Cut-Off Voltage	16 - 24 V	19.1 V		✓	✓	✓

This parameter is only used when **Deep Discharge Beeper** (4.4.1.10) has the value 'Yes'.

The Battery Cut-Off Voltage specifies the voltage at which the battery is empty and battery damage will occur if the battery is discharged any further. If the battery voltage falls below this value, the R-series gives the user an audible warning.

Contact your battery supplier for the cut-off level of your batteries. Typically, the cut-off level for lead-acid batteries is 21V.



Note:

An audible deep discharge warning is required to comply with ISO7176-14.

4.4.7.6 Battery Gauge Dead-band

Parameter	Possible Values	Default	HHP	Lite	Std	Adv
Battery Gauge Dead-band	0 - 6 V	3.5 V				✓

Prevents the battery gauge from increasing when the battery voltage recovers after driving.

If the scooter is driving, the battery voltage will be lower than when the scooter stands still. However, the actual charge of the battery does not increase during standstill, even though the voltage has increased. This can cause the battery gauge to increase as well, showing a charge that is too high during standstill.

Battery Gauge Dead-band makes sure that the battery gauge only shows a higher charge when the battery is actually being charged. Any increase in battery voltage that is lower than the value of **Battery Gauge Dead-band** is ignored.

4.4.7.7 Battery Gauge Sensitivity

Parameter	Possible Values	Default	HHP	Lite	Std	Adv
Battery Gauge Sensitivity Battery Capacity (HHP - A,B,C)	0 - 170	40	✓			✓

Adjusts the speed with which the battery gauge reacts to voltage fluctuations of the battery.

Batteries with a higher capacity take more time to discharge. For this reason, the battery gauge should react slower with high-capacity batteries to ignore fast voltage fluctuations that happen when the scooter encounters temporary loads such as a ramp.

If the battery voltage is less than the battery gauge currently indicates, the battery gauge decreases by 5% after **Battery Gauge Sensitivity** x 1.5 seconds. The 100% range of the battery gauge falls between **Battery Gauge Minimum** and **Battery Gauge Maximum**.

For better battery gauge accuracy, increase the value of **Battery Gauge Sensitivity** with high-capacity batteries and decrease the value with low-capacity batteries.

In older versions of the R-series, this parameter was called **Battery Capacity** by the HHP.

4.4.8 System Options

4.4.8.1 Service Scheduler

Parameter	Possible Values	Default	HHP	Lite	Std	Adv
Service Scheduler	No / Yes	Yes			✓	✓
Service Period	0 - 5100 h	5000 h	✓	✓	✓	✓

The Service Scheduler is a preventative maintenance feature that allows the OEM to set up scheduled servicing plans for their scooter customers.

To enable the Service Scheduler function, set **Service Scheduler** to 'Yes'.

Service Period sets the drive time between service schedules. When this number of hours has been exceeded, the status indicator will flash slowly 3 times every time the scooter is turned on or wakes up from sleep, to indicate that a service is due. This is repeated every 15 minutes.

To clear the service indication, either set the value of **Service Period** to zero, or erase the controller history with the Wizard:

Tools -> Erase Controller History.



Note:

Erasing the controller history erases the fault log as well.

Consequently, erasing the controller history to erase the fault log will reset the service scheduler as well.

4.4.9 Multi-function Inputs Configuration

4.4.9.1 Pin [X] Function

Parameter	Possible Values	Default	HHP	Lite	Std	Adv
Pin 4 Function	None	None			✓	✓
Pin 6 Function	Reverse Drive Release Brake Charger Inhibit Profile2				✓	✓
Pin 12 Function	Slow Slow/Stop				✓	✓
Pin 14 Function	Slow/Stop FWD Slow/Stop REV				✓	✓
Prog/Inh Pin Function	SRW Neutral Detect**				✓	✓

The Program/Inhibit (P/I) pin (pin 4) of the charger connector and pins 4, 6, 12 and 14 of the tiller head connector can be configured as input pins.

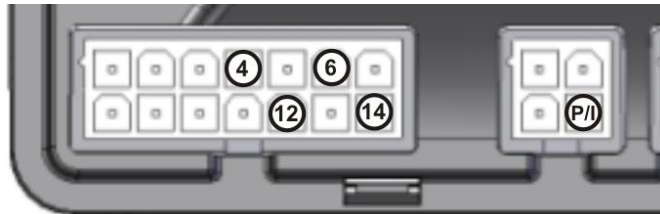

Connect external switches or potentiometers to the input pins to activate one of the following functions:

- None** - No function, normal drive in all states.
- Reverse Drive** - When this function is active, it swaps the throttle direction. This function can be used for a 'Reverse' switch when **Throttle Type** (4.4.2.1) is set to 'Single-ended' or 'Uni-polar'. If this function is activated while driving, the scooter will immediately decelerate to zero at the normal rate and then accelerate in the opposite direction. If multiple pins are programmed to perform **Reverse Drive**, they work in parallel: reverse drive applies as long as any combination of one or more pins is activated.
- Release Brake** - When this function is active, the Park brake is released electrically, so that it is possible to push the scooter. It is not possible to drive the scooter while the park brake is released.

To prevent a rollaway situation while the park brake is released, the scooter will stop if the speed during pushing is higher than the value of the **Push Speed** parameter (4.4.3.13).

If the switch is active at power-up or is activated while driving, a park brake fault flash code will show on the Status light, but the scooter will still drive

normally. In this case, the **Release Brake** function will be disabled and the state of the associated input pin ignored until the power is cycled.



Warning:

The Release Brake function will not release the park brake while the scooter is inhibited from driving due to charger inhibit, a stop function or during programming with the Wizard.

- Charger Inhibit** - Stops the scooter at the programmed **Emergency Deceleration** and inhibits drive. If **Latches** is set to 'Yes', the scooter must be turned off and on before it is possible to drive again. If **Flashes*** is set to 'Yes', the Status Light will show a "Drive Inhibit" flash code while the drive inhibit is active. See section 5.2 for more information on flash codes.
Note: to make the charger inhibit pin compatible with the industry standard where the inhibit signal must be connected to B- to activate inhibit, set **Active** to 'Low'.
- Profile 2** - When this function is active, the scooter switches to Profile 2 (see 4.4.3). A typical application for Profile 2 is a user-selectable 'slow speed' mode that can be used indoors, while Profile 1 is selected for outdoor use. Apart from only a limited speed, the indoor profile can have its acceleration and deceleration set lower as well.
- Slow** - Limits the maximum speed of the scooter to the value that is set with **Slows To**. Has no effect on scooter acceleration or deceleration. **Slows To** is a percentage of **Maximum Forward Speed** (4.4.3.1) or **Maximum Reverse Speed** (4.4.3.4). For example, if **Maximum Forward Speed** is set to 80% and **Slows To** is set to 50%, the resulting maximum speed will be the value of **Slows To** i.e. 50%.
 If **Slows To** is set to 0%, the function behaves the same as the 'Stop' state of the **Slow/Stop** function (including latching and flashing), which is described below. If **Slows To** is set higher than 0%, The **Slow** function does not latch or flash.
- Slow/Stop** - This function has three states:
 - **Normal drive** (pin not connected).
 - **Slow** (2.2 kΩ connected to B+ if **Active** High or B- if **Active** Low). Operates the same as the **Slow** function.
 - **Stop** (pin connected to B+ if **Active** High or B- if **Active** Low). Stops the scooter at the programmed **Emergency Deceleration** and inhibits drive. If **Latches** is set to 'Yes', the scooter must be turned off and on before it is possible to drive again. If **Flashes*** is set to 'Yes', the Status Light will show a "Drive Inhibit" flash code while the drive inhibit is active. See section 5.2 for more information on flash codes.
 Only valid **Active** settings are 'High' and 'Low', all other settings disable the input (the input will never become active).
- Slow/Stop FWD** - The same as **Slow/Stop**, but only applies to the forward direction, reverse drive is not affected. If **Latches** is set to 'No' and forward Stop has been activated and released, forward drive will still not be possible until the scooter has stopped and the throttle has been returned to neutral. Flash codes are not used during this function (**Flashes*** is ignored).

- Slow/Stop REV** - The same as **Slow/Stop**, but only applies to the reverse direction, forward drive is not affected. If **Latches** is set to 'No' and reverse Stop has been activated and released, reverse drive will still not be possible until the scooter has stopped and the throttle has been returned to neutral. Flash codes are not used during this function (**Flashes*** is ignored).
- SRW** - The **Speed Reduction Wiper** function provides an analogue input that can be used for a user-operated speed limit pot, or an anti-tip feature that automatically limits the speed of the scooter while turning. For more information, see the description of the **Speed Reduction Wiper (SRW) parameters** (4.4.3.15).
- Neutral Detect**** - To prevent a runaway caused by a faulty electrical throttle circuit, this function compares the throttle signal with the signal from a 'neutral' switch. The 'neutral' switch must be mechanically connected to the throttle so that it activates when the throttle is in the true neutral position. If the throttle now gives an out-of-neutral output signal when the 'neutral' switch is still active, the R-series does not drive and the Status light shows a "Throttle Fault" flash code (FC 7). The scooter must be turned off and on to clear the fault.

For this function to work correctly, the 'neutral window' of the throttle (as set with the **Throttle Dead-band** parameter, see 4.4.2.6) must be larger than the active range of the 'neutral' switch.

Only valid **Active** settings are 'High', 'Low' and 'Open', all other settings will result in throttle faults. See also Neutral Detect Active States (6.1).

* The **Flashes** setting is available in controller software Rev. D and higher.

** The **Neutral Detect** setting can only be used with Dual Decode variants (see chapter 1).



Note:

If 'Latches' is selected, please select 'Flashes' as well to indicate to the user why the scooter will not drive.

4.4.9.2 Active States

The input pins can be set to the following active states:

- Low** - Input is active when pulled down, inactive when open or pulled up
- High** - Input is active when pulled up, inactive when open or pulled down
- Open** - Input is active when open, inactive when pulled up or pulled down
- Low or High** - Input is inactive when open, active when pulled up or pulled down
- Low or Open** - Input is inactive when pulled up, active when open or pulled down
- High or Open** - Input is inactive when pulled down, active when open or pulled up

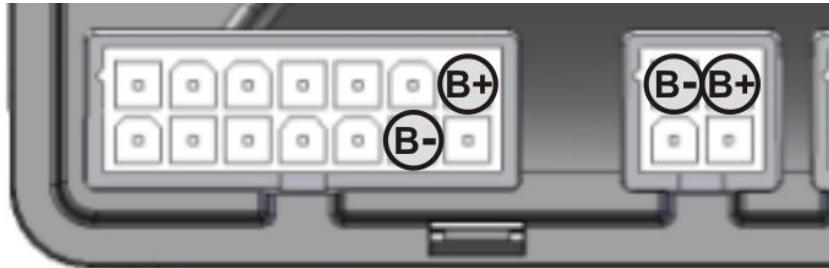

To pull up an input, connect it to B+. To pull down an input, connect it to B-.

4.4.10 Multi-function Outputs Configuration

4.4.10.1 Flash Code Type

Parameter	Possible Values	Default	HHP	Lite	Std	Adv
Flash Code Type	Scooter Shark Type 3 Type 4	Scooter			✓	✓

To make the most of your existing industry knowledge of products, the R-series has the ability to display a variety of different flash code types.

Scooter		Shark	
#	Meaning	#	Meaning
1	Battery Low	1	Stop function / Charger Inhibit
2	Low Battery Fault	2	Battery Fault
3	High Battery Fault	3	Motor Fault
4	Stall Time-out / Controller too hot	4	Stall Time-out / Controller too hot
5	Park brake Fault	5	Park brake Fault
6	Drive Inhibit	6	- (unused)
7	Speed Pot / Throttle Fault	7	Speed Pot / Throttle Fault
8	Motor Voltage Fault	8	System / Internal Fault
9	Other / Internal		
Type 3		Type 4	
#	Meaning	#	Meaning
1	Battery Low	1-1	Thermal Cut-back / Stall
2	Bad Motor Connection	1-2	Throttle Trip
3	Motor Short Circuit	1-3	Speed Limit Pot Fault
4	Stall Time-out / Controller too hot	1-4	Under Voltage Fault
5	- (unused)	1-5	Over Voltage Fault
6	Drive Inhibit	2-1	Main Contactor Driver Off Fault
7	Speed Pot / Throttle Fault	2-2	- (Unused)
8	Controller Fault	2-3	Main Contactor Fault
9	Park brake Fault	2-4	Main Contactor Driver On Fault
10	High Battery Voltage	3-1	Dr. inhibit / OONAPU / Proc or Wiring
		3-2	Brake On Fault
		3-3	Precharge Fault
		3-4	Brake Off Fault
		3-5	High Pedal Disable Fault
		4-1	Current Sense Fault
		4-2	Motor Voltage Fault
		4-3	EEPROM Fault
		4-4	Power Section Fault

See Section 5.2 for a full description of the flash codes.

The Wizard Diagnostics Report lists the currently selected Flash Code type.

4.4.10.2 Pin 3/11 Function

Parameter	Possible Values	Default	HHP	Lite	Std	Adv
Pin 3 Function	None Brake Light Reverse Light Beeper	Beeper			✓	✓
Pin 11 Function	Status Power Status	Status			✓	✓

These parameters set the function of Pin 3 and pin 11 on the tiller connector.

Pin 3 and pin 11 are both capable to sink 500 mA. To use the outputs, connect a 24V beeper, lamp, or Status LED (with resistor) between B+ and pin 3 or pin 11.

- None** - The output is not used.
- Brake Light** - The output pin drives a 24V Brake Light. The brake light is on when the scooter decelerates in either the forward or reverse direction. Connect the light between B+ and the pin that has 'Brake Light' selected.
- Reverse Light** - The output pin drives a 24V Reverse Light. Connect the light between B+ and the pin that has 'Reverse Light' selected.
- Beeper** - The output pin drives a 24V beeper. Connect the beeper between B+ and the pin that has 'Beeper' selected. To activate any beeper sounds, set **Enable Beeper** (4.4.1.4) to 'Yes'. Other beeper options can be selected with **Flash Code Beeper** (4.4.1.5), **Sleep Beeper** (4.4.1.6), **Motion Beeper** (4.4.1.8), **Deep Discharge Beeper** (4.4.1.10) and **Beeper Timing** (4.4.1.9).
- Status** - The output pin drives a Status light. The Status light is on when the power is on. When a fault condition exists, the Status light shows the related flash code.
- Power Status** - The output pin drives a Power-on light. The Power-on light is on when the power is on. The Power-on light does not show flash codes, it remains on continuously.

If an output is set to 'Brake Light', 'Reverse Light', 'Status' or 'Power Status', the light to use can be a 24V LED array (max. 500mA) or a relay-driven incandescent or halogen bulb. If a relay is used, a fly-back diode and a series diode must be installed. If an LED array is used, it must have its own internal current limiting system. An LED array must also have reverse polarity protection such as a series diode. An LED array may show a faint glow if the output is not active. If this is the case, resistors mounted in parallel to the LED array may reduce the glow.

For more information and schematics, see [Status Indicator Output](#) (section 3.7.10), [Beeper Output](#) (section 3.7.11) and [Brake and Reversing Lights](#) (section 3.7.13).

4.4.10.3 Pin 10 Function

Parameter	Possible Values	Default	HHP	Lite	Std	Adv
Pin 10 Function	None Status High Status Low 5V Gauge 12V Gauge Other	None			✓	✓

Sets the function of Pin 10 on the tiller connector.

Pin 10 is capable to sink 50 mA at 24V and to source 10 mA at 12V.

- None** - The output is not used.
- Status High** - The output pin drives a 12 V Status LED (10 mA max). The Status LED is on when the power is on. When a fault condition exists, the Status LED shows the related flash code. Connect the LED between pin 10 and B-. Install a resistor that limits the current to 10 mA at 12 V. See also [Status Indicator Output](#) (section 3.7.10).
- Status Low** - The output pin drives a 24 V Status LED or lamp (50 mA max). The Status LED is on when the power is on. When a fault condition exists, the Status LED shows the related flash code. Connect the LED between B+ and pin 10. Install a resistor that limits the current to 50 mA at 24 V. See also [Status Indicator Output](#) (section 3.7.10).
- 5V Gauge** - The pin will show the state of the battery on an analogue 5V voltmeter battery gauge. Connect the battery gauge between pin 10 and B-. See also [Battery Gauge Output](#) (section 3.7.12).
- 12V Gauge** - The pin will show the state of the battery on an analogue 12V voltmeter battery gauge. Connect the battery gauge between pin 10 and B-. See also [Battery Gauge Output](#) (section 3.7.12).
- Other** - Drives a digital multi-LED battery gauge display. Connect the LED battery gauge between B+ and B-. Connect pin 10 to the "Data In" input of the LED battery gauge. If a Battery Charger inhibit is activated, the gauge shows a charging sequence. If a flash code condition exists, the flash code number is indicated by the number of flashes (same as for a single status indicator), regardless of the number of bars lit. The number of bars lit continues to indicate the battery gauge level during flash code indication.

4.4.10.4 Key Switch Status LED

Parameter	Possible Values	Default	HHP	Lite	Std	Adv
Key Switch Status LED	No / Yes	Yes				✓

To reduce current drain, set this parameter to 'No' if a status LED is not wired in series with the key switch.

5 Diagnostics



Note:

The R-series is not user serviceable. Specialised tools are necessary for the repair of any R-series component.

5.1 Introduction

An abnormal condition may be indicated by a flash code on the Status output. A Flash Code is a sequence of flashes, separated by a pause, followed by a repetition of the sequence. Additionally, Flash Codes may be sounded by connecting a beeper to a suitably programmed output and setting the **Flash Code Beeper** parameter (4.4.1.5) to 'Yes'. Depending on the condition, the scooter may or may not allow driving. In some cases driving may be allowed but in a reduced speed ('limp') mode.

5.2 Flash Code Display

To make the most of your existing industry knowledge of products, the R-series has the ability to display a variety of different flash code types. These may be one of Scooter, Shark, Type 3, or Type 4. The Diagnostics Report lists the Flash Code type that the controller is currently set to display. See the following sections for each set of flash code details.



Note:

*In addition to the Flash Codes detailed next, a special low battery warning can be enabled by setting parameter **Deep Discharge Beeper** to **Yes**. This warning is a requirement of various safety standards. The scooter will output a visible and audible low battery warning if the battery voltage drops below its cut-off voltage. The warning will be two short flashes, and will take priority over all other flash codes in the system.*

5.2.1 Scooter Flash Codes

Flash	Description	Meaning
1	Battery Low	The batteries are running low. <ul style="list-style-type: none"> Recharge the batteries.
2	Low Battery Fault	The batteries have run out of charge. <ul style="list-style-type: none"> Recharge the batteries. Check the battery and associated connections and wiring.
3	High Battery Fault	Battery voltage is too high. This may occur if overcharged &/or travelling down a long slope. If travelling down a slope, reduce your speed to minimise the amount of regenerative charging.
4	Current Limit Time-out or Controller too hot	The motor has been exceeding its maximum current rating for too long. <ul style="list-style-type: none"> The scooter may have stalled. Turn the controller off, leave for a few minutes and turn back on again. The motor may be faulty. Check the motor and associated connections and wiring.
5	Park Brake Fault	Either a park brake release switch is active or the park brake is faulty. <ul style="list-style-type: none"> Check the park brake and associated connections and wiring. Ensure any associated switches are in their correct positions.
6	Drive Inhibit	Either a Stop function is active or a Charger Inhibit or OONAPU condition has occurred. <ul style="list-style-type: none"> Release the Stop condition (seat raised etc.) Disconnect the Battery Charger Ensure the throttle is in neutral when turning the controller on. The Throttle may require re-calibration.
7	Speed Pot Fault	The throttle, speed limit pot, SRW or their associated wiring may be faulty. <ul style="list-style-type: none"> Check the throttle and speed pot and associated connections and wiring.
8	Motor Voltage Fault	The motor or its associated wiring is faulty. <ul style="list-style-type: none"> Check the motor and associated connections and wiring.
9	Other error	The controller may have an internal fault. <ul style="list-style-type: none"> Check all connections & wiring.

5.2.2 SHARK Flash Codes

Flash	Description	Meaning
1	User Fault / Drive Inhibit	<p>Either a Stop function is active or a Charger Inhibit condition has occurred.</p> <ul style="list-style-type: none"> • Release the Stop condition (seat raised etc.) • Disconnect the Battery Charger • Turn the controller off and then on again.
2	Battery Fault	<p>Battery voltage is either too low or too high.</p> <ul style="list-style-type: none"> • If you have been driving normally the batteries may be depleted. Recharge the batteries. • If you are travelling down a slope, the batteries may be overcharged. Reduce your speed to minimise the amount of regenerative charging • Check the battery and associated connections and wiring.
3	Motor Fault	<p>The motor has been exceeding its maximum current rating for too long, or may be faulty.</p> <ul style="list-style-type: none"> • Turn the controller off, leave for a few minutes and turn back on again. • Check the motor and associated connections and wiring.
4	Current Limit Time-out or Controller too hot	<p>The motor has been exceeding its maximum current rating for too long.</p> <ul style="list-style-type: none"> • The scooter may have stalled. Turn the controller off, leave for a few minutes and turn back on again. • The motor may be faulty. Check the motor and associated connections and wiring.
5	Park Brake Fault	<p>Either a park brake release switch is active or the park brake is faulty.</p> <ul style="list-style-type: none"> • Check the park brake and associated connections and wiring. • Ensure any associated switches are in their correct positions.
6	<i>unused</i>	
7	Throttle Fault	<p>The Throttle is out of neutral when turning the controller on. The throttle or speed limit pot, or their associated wiring may be faulty.</p> <ul style="list-style-type: none"> • Ensure the throttle is in neutral when turning the controller on. • The Throttle may require re-calibration. • Check the throttle and speed pot and associated connections and wiring.
8	System Fault	<p>The controller may have an internal fault.</p> <ul style="list-style-type: none"> • Check all connections & wiring.

5.2.3 Type 3 Flash Codes

Flash	Description
1	Low Battery
2	Bad Motor Connection
3	Motor Short Circuit
4	Current Limit Time-out / Controller too hot
5	<i>unused</i>
6	Drive Inhibit
7	Throttle Fault
8	Controller Fault
9	Park Brake Fault
10	High Battery Voltage

5.2.4 Type 4 Flash Codes

A Type-4 flash code involves the use of twin-flashes to identify the type of fault.

Flash	Description
1-1	Thermal Cut-back / Stall
1-2	Throttle Trip
1-3	Speed Limit Pot Fault
1-4	Under Voltage Fault
1-5	Over Voltage Fault
2-1	Main Contactor Driver Off Fault
2-2	<i>Unused</i>
2-3	Main Contactor Fault
2-4	Main Contactor Driver On Fault
3-1	Drive inhibit / OONAPU / Proc or Wiring Fault
3-2	Brake On Fault
3-3	Precharge Fault
3-4	Brake Off Fault
3-5	High Pedal Disable Fault
4-1	Current Sense Fault
4-2	Motor Voltage Fault
4-3	EEPROM Fault
4-4	Power Section Fault

5.3 Diagnostics Tools

While the R-series may indicate the abnormal condition, a hand held programmer or the PC-based Wizard 5 will provide more detailed information on the fault.

Hand Held Programmer

Plugging a hand held programmer into the R-series when an abnormal condition exists will cause the fault to be displayed on the screen. A short text will be displayed which indicates the condition. A latching fault will be logged in the fault log as a 4-digit code. The first two digits provide the flash code number; the second two digits provide more specific diagnostics information that is suitable for repair technicians. See section 4.1.2 for details.

While there are alternative flash code sequences that may be flashed on the status LED, the hand held programmer will only display the appropriate Scooter Flash Code information. For instance if the Shark Flash Codes are used, the Status LED will display an 8-Flash code for an internal error. When the hand held programmer is plugged in, it will display a flash code 9 on the screen.

DYNAMIC Wizard

Wizard is the preferred diagnostics tool in the workshop environment, providing a full fault history (last 16) and verbal descriptions of each flash and associated servicing code.

If after analysing the data, the condition cannot be diagnosed, it is possible to print or save a Status Report for further analysis or distribution through fax or email to a service centre.

Fault log

The R-series contains a fault log that stores the last occurred faults in sequence. The fault log can be accessed with the HHP and with the Wizard (by making a diagnostics report).

It is possible to clear the fault log with the Wizard:

Tools -> Erase Controller History.



Note:

Erasing the controller history will reset the Service Scheduler (5.6) as well.

5.4 HHP Fault Codes with Sub Codes

Code	Fault source	Sub code	Meaning
01	User	01	Out Of Neutral At Power Up (OONAPU) testing going on <ul style="list-style-type: none"> Release the throttle and wait for the test to be finished
		02	A warning is being displayed on the Battery Gauge
		03	Chair needs to be serviced <ul style="list-style-type: none"> Contact your service agent
02	Battery	00	Voltage too high <ul style="list-style-type: none"> Batteries may be overcharged: if driving downhill, slow down
		01	Voltage too high – emergency stop occurred <ul style="list-style-type: none"> Batteries may be overcharged: if driving downhill, slow down
03	Motor	00	Short circuit <ul style="list-style-type: none"> Check the motor cables for damage Motor brushes may be too stiff, bouncing against the case <ul style="list-style-type: none"> Replace motor brushes or motor
		01	Open circuit <ul style="list-style-type: none"> Check if the motor cables are loose Motor brushes may be worn <ul style="list-style-type: none"> Turn wheels to reconnect Replace motor brushes or motor
		02	Motor terminal connected to battery negative (-) <ul style="list-style-type: none"> Check if the motor has been connected correctly Check the motor cables for damage
		03	Motor terminal connected to battery positive (+) <ul style="list-style-type: none"> Check if the motor has been connected correctly Check the motor cables for damage
		04	Motor voltage is not what it should be during drive <ul style="list-style-type: none"> Possible motor short circuit <ul style="list-style-type: none"> check the motor cables for damage Motor brushes may be too stiff and bouncing Otherwise internal controller fault, contact Dynamic
		07	Intermittent short circuit <ul style="list-style-type: none"> Check for damaged cables Motor brushes may be too stiff, bouncing against the case <ul style="list-style-type: none"> Replace motor brushes or motor
		04	Park brake
04	Park brake	01	Park brake not connected, short circuit or broken <ul style="list-style-type: none"> Check if the cables of the park brake are loose or damaged
		04	Park brake short circuit or broken <ul style="list-style-type: none"> Check the park brake cables for damage

Code	Fault source	Sub code	Meaning
05	Throttle	00	Throttle wiper (pin 1 on Tiller Connector) voltage out of spec <ul style="list-style-type: none"> • Check the throttle cables for damage • Recalibrate throttle • Replace the throttle pot
		01	Throttle Positive (pin 2 on Tiller Connector) or Throttle Negative (pin 8 on Tiller Connector) out of spec <ul style="list-style-type: none"> • Check the throttle cables for damage • Replace the throttle pot
		02	Speed pot fault, treating speed pot as set to minimum <ul style="list-style-type: none"> • Check speed pot cable for damage • Replace speed pot
		03	Speed Reduction Wiper (SRW) fault, treating as set to minimum <ul style="list-style-type: none"> • Check SRW cable for damage • Replace SRW
		04	Out Of Neutral At Power Up (OONAPU) <ul style="list-style-type: none"> • Release the throttle and try again
		05	Calibration fault <ul style="list-style-type: none"> • Recalibrate throttle • Check the throttle cables for damage • Replace the throttle pot
		06	Throttle calibration in progress <ul style="list-style-type: none"> • Finish the calibration instructions
06	I/O	01	Battery gauge fault, battery gauge deactivated <ul style="list-style-type: none"> • Check if the battery gauge cables are damaged or loose
07	Rollaway	02	The scooter moved too fast when the park brakes were released <ul style="list-style-type: none"> • Turn the scooter off and back on again
08	Internal fault	All	Contact Dynamic
09	Thermal fault	04	Thermal fault <ul style="list-style-type: none"> • Case or FET or motor temperature too high • Stall time-out exceeded
09	Internal fault	Other	Contact Dynamic

5.5 Advanced Diagnostics Logs

In addition to the standard diagnostics reports, additional diagnostic information is available from the controller using the Wizard or HHP. This additional information is extremely useful for identifying the root cause of any faults, and allows for a faster, more efficient service process. It will also allow for feedback to be given to the user if their use of the scooter is causing any issues.

There are two sources of the advanced diagnostics logs; the **Usage Counters** provide detailed information on the use of the scooter; the **Run-time Readings** provide real-time analysis of the system in operation.

Usage Counters (available in both Wizard and HHP)

Counter	Description
Powered Up Time	The total amount of time (hours) the controller has been turned on.
Powered Up Count	The number of times the controller has been turned on.
Drive Time	The total amount of time (hours) the controller has been driving (park brakes disengaged).
Drive Count	The number of times the controller has been driving (number of times the park brakes have disengaged).

Run-time Readings (available in HHP – Technician mode only)

Reading	Description
Battery (V)	The voltage of the batteries.
Motor (V)	The voltage being applied to the motor.
Motor (A)	The current being applied to the motor.
Temperature (C)	The internal temperature of the controller.
Throttle (V)	The voltage of the throttle.

5.6 Service Scheduler

The Service Scheduler is a preventative maintenance feature that allows the OEM to set up scheduled servicing plans for their scooter customers.

If enabled, a Service Period can be programmed into the controller. Once the Drive Time exceeds this value, the status LED will flash slowly 3 times every time the scooter is turned on or wakes up from sleep, to indicate the service is due.

To enable the Service Scheduler function, set **Service Scheduler** (4.4.8.1) to 'Yes' and set **Service Period** to the desired number of drive time hours before a service is due.

To clear the service indication, either set the value of Service Period to zero, or erase the controller history with the Wizard:

Tools -> Erase Controller History.



Note:

Erasing the controller history erases the fault log as well.

Consequently, erasing the controller history to erase the fault log will reset the service scheduler as well.

6 Appendices

6.1 Neutral Detect Active States

The following options are available to setup a Neutral Detect circuit.

Active State	Switch in Neutral	Switch connected to	Neutral	Driving	Short circuit in Neutral	Short circuit while driving	Open wire in neutral	Open wire while driving
Low	Closed	B- (Pin 13)	no Fault	no Fault	no Fault	no Driving, FC7	FC7	Cannot start driving with an open wire, but a wire break during driving is not detected*
High	Closed	B+ (Pin 7)	no Fault	no Fault	no Fault	no Driving, FC7	FC7	Cannot start driving with an open wire, but a wire break during driving is not detected*
Open	Open	B- (Pin 13) or B+ (Pin 7)	no Fault	no Fault	FC7	Cannot start driving with a short circuit, but a short circuit during driving is not detected*	no Fault	FC7

*As soon as the throttle is returned to neutral, the wire fault will result in FC7 and Drive Inhibit.

6.2 Parts List

Dynamic R-Series Installation Manuals

Part Description	DCL Part #	Qty/Unit
Dynamic R-series Installation Manual	GBK52040	1



Dynamic R-Series Connectors

Part Description	DCL Part #	Qty/Unit
R50 Connector Set	DR-CONSETA	1

Dynamic R-Series Programming Accessories

Part Description	DCL Part #	Qty/Unit
Dynamic Wizard Programming Adapter	DWIZ-ADAPT	1
DR PROGRAMMER ADAPTOR LOOM 0.2m	DR-PRGLM02	1
Wizard Kit – Programming Kit Contains software, cables and adapter (no dongle)	DWIZ-KIT*	1
Wizard – Software Only (CD)	DWIZ-SW	1
<u>Wizard Dongles – USB port</u>		
OEM/Advanced version	DWD-OEM-U	1
Enhanced dealer/Standard version	DWD-EDL-U	1
Dealer/Lite version	DWD-DLR-U	1
Factory version	DWD-FAC-U	1
<u>DX Hand Held Programmer</u> (includes DWIZ-ADAPT and DR-PRGLM02)	DX-HHP	1



*Note: The DWIZ-KIT does NOT include DR-PRGLM02 but it does include DWIZ-ADAPT.

6.3 **Intended Use and Regulatory Statement**

Intended Use

The R-Series scooter controller is intended to provide speed control for small or medium sized scooters that utilise a single 24V DC brushed motor and integrated park brake. The controller will respond to user input demand via an analogue input in terms of direction (forward and reverse) and speed.

The scooter manufacturers are provided with all the integration, set-up, operating environment, test and maintenance information needed in order to ensure reliable and safe use of the controller.

Device Classification

Europe

The R-Series Controller is a component of a Class I medical device as detailed in the Council Directive 93/42/EEC concerning Medical Devices.

USA

The R-Series Controller is a component of a Class II medical device (Motorised Scooter) as detailed in 21 CFR § 890.3800.

A wheelchair component is classified under 21 CFR 890.3920 as Product Code KNN, Class 1, 510(k) exempt.

Compliance and Conformance with Standards

In accordance with the device classification, the R-Series scooter controller is designed to enable the scooter manufacturer to comply with the relevant requirements of the European Medical Device Directive 93/42/EEC as amended and 21 CFR § 820.30.

The R-Series scooter controller has been designed such that the combination of the scooter and controller, along with accessories as applicable, complies with the Essential Requirements of the MDD by adopting relevant clauses of harmonised standards EN12184 and EN12182 and the FDA Consensus standard ANSI/RESNA WC-2 for performance.

However, final compliance of the complete scooter system with international and national standards is the responsibility of the scooter manufacturer or installer.

Programming Adapter

The programming adapter is intended to allow the R-Series scooter controllers the ability to communicate with the Wizard and the DX Hand Held Programmer. The adapter is not intended to alter the controller in any way, but simply passes information to and from the controller. The information passed may alter the controller performance.

The intended power source is a 24V battery supply from the controller. The intended environment is indoors, or outdoors in dry conditions.

6.4 **Service life**

If the product has been installed, used and maintained as recommended, all instructions contained in this manual have been properly followed, and the unit has not been abused, the expected service life period (i.e. serviceable life expectancy) of the product is five (5) years. After this period, DYNAMIC CONTROLS recommends the product be replaced for safety reasons. DYNAMIC CONTROLS accepts no responsibility or liability for product failure if the product is retained in use beyond the stated service life period.

6.5 Maintenance

The following instructions must be passed on to the operator before use of the product.

- Keep all DYNAMIC CONTROLS products free of dust, dirt and liquids. To clean the product, use a cloth dampened with warm soapy water. Do not use chemicals, solvents or abrasive cleaners, as this may damage the product.
- Monthly check all vehicle components for loose, damaged or corroded components, such as connectors, terminals, or cables. Restrain all cables to protect them from damage. Replace damaged components.
- Once every 6 months, test all switchable functions on the DYNAMIC CONTROLS electronics system to ensure they function correctly.
- There are no user-serviceable parts in any DYNAMIC CONTROLS electronic product. Do not attempt to open any case or undertake any repairs, else warranty will be voided and the safety of the system may be compromised.
- Where any doubt exists, consult your nearest service centre or agent.



Warning:

It is the responsibility of the end user to maintain the product in a state of good repair at all times. If any component is damaged in any way, or if internal damage may have occurred (for example by being dropped), have it checked by qualified personnel before operating.

6.6 Warranty

All equipment supplied by DYNAMIC CONTROLS is warranted by the company to be free from faulty workmanship or materials. If any defect is found within the warranty period, the company will repair, or at its discretion replace, the equipment without charge for materials or labour.

This warranty is subject to the provisions that the equipment:

- has been correctly installed
- has been thoroughly checked upon completion of installation, and all programmable options correctly adjusted for safe operation prior to use
- has been used solely in accordance with this manual and all other manuals of the DYNAMIC CONTROLS products that are used on the mobility vehicle
- has been properly connected to a suitable power supply in accordance with this manual
- has not been subjected to misuse or accident, or been modified or repaired by any unauthorised personnel
- has not been connected to third party devices without the specific approval of DYNAMIC CONTROLS
- has been used solely for the driving of electrically powered mobility vehicles in accordance with the intended use and the recommendations of the vehicle manufacturer

6.7 Safety and Misuse Warnings

Warnings to be included in the User Manual

The following warnings are applicable to the end user as well as the installer of the product, and must be passed on to the end user before use.

1. Do not install, maintain, or operate this equipment before you have read and understood all the instructions and all the manuals for this product and all the other products that you use or install together with this product. Follow the instructions of the manuals. If you do not follow all instructions, injury or damage can be the result.
2. Do not try to open or disassemble any case - there are no user-serviceable parts inside.
3. The operator has the responsibility to keep the vehicle in a good safe operating condition. To protect all the components (for example the cables) from damage, the operator must fasten them in optimum positions.
4. If operators of the vehicle are left with limited or no mobility for any reason (for example, because the vehicle loses electric power or breaks down), it is important that they can still call for assistance from wherever they may be.
5. Make sure that the product does not become colder or hotter than the minimum and maximum temperatures specified in this manual.
6. Do not touch the connector pins. If you touch the pins, they can become dirty or they can be damaged by electrostatic discharge.
7. During normal operation the controller may become hot. Before handling the controller check its temperature is not too excessive to handle safely.
8. Most electronic equipment is influenced by Radio Frequency Interference (RFI). Be careful when portable communications equipment is used in the area around such equipment. DYNAMIC CONTROLS has made every effort to make sure that RFI does not change the behaviour of the controller, but very strong signals can still cause a problem. The vehicle manufacturer has the responsibility to make sure that the vehicle is tested according to local EMC regulations.
9. Immediately turn the controller off and consult your service agent if the vehicle
 - o is damaged
 - o does not behave the same every time
 - o does not respond normally, the way you expect it to
 - o becomes hotter than normal
 - o smokes
 - o arcs
 - o does not change its speed when you adjust the speed reduction pot or the speed reduction switch (if one is available on your vehicle)
 - o shows a fault on its fault indicator and the controller does not perform normally.
10. Turn the controller off
 - o when you do not use it
 - o before you get in or get out of the vehicle
 - o before you answer or make a call from a mobile phone or a portable communications device near the vehicle
 - o if your vehicle drives by itself or against your will. When you turn the controller off the vehicle will halt.
11. In the case of an emergency while the vehicle is driving, press the On/Off button or turn the key switch to perform an emergency stop and turn the controller off.
12. If the controller indicates that the battery is low, recharge the battery as soon as possible. The life of the battery decreases faster if the battery has a low charge; the longer a battery remains at a low charge, the shorter its life will be. Do not drive the vehicle if the battery is almost empty, this may cause the vehicle to drive slower or stop. If the battery becomes completely empty, the vehicle may stop suddenly.
13. Make sure that the battery charger that is used with the vehicle has a drive inhibit function that is correctly connected for use with the controller. If you are not sure, ask your dealer or vehicle manufacturer.

14. Operation of a vehicle on steep slopes can be dangerous. Before you drive up or down a slope, make sure that the slope does not exceed the capability of the vehicle.
15. Do not use the park brake release on a slope.
16. Go downhill slowly. When the vehicle drives downhill, the motors act as a dynamo and generate energy. The controller sends the generated energy from the motor to the battery. This charges the battery. However, if the battery is fully charged, it cannot accept the generated energy anymore. When this happens, there is a risk of damage to the battery or an explosion. To prevent this risk, the controller forces the vehicle to slow down until the battery can accept more energy. After this, it allows the vehicle to speed up again. The result of this will be sudden speed changes of the vehicle. To prevent these speed changes with fully charged batteries, turn on the lights (if fitted) and decrease the speed of the vehicle when going downhill.
17. The controller can cause the vehicle to come to a sudden stop. If this can be dangerous to the operator, the installer must install a seat belt, and the operator must wear this seat belt.
18. Performance adjustments must only be made by healthcare professionals, or by persons who completely understand the programming parameters, the adjustment process, the configuration of the vehicle, and the capabilities of the driver. Wrong settings can make the vehicle uncontrollable or unstable. An uncontrollable or unstable vehicle can cause an unsafe situation such as a crash, with the risk of serious injury to the driver or bystanders, or damage to the vehicle or surrounding property.
19. Performance adjustments must only be made indoors, or outdoors in dry conditions.

Service and Configuration Warnings

The following warnings are applicable to the installation technician and the dealer or the therapist who supplies the vehicle to the end user.

20. It is the responsibility of the installer to make sure that accessories that are connected to the wires of the vehicle do not interfere with the operation of the controller.
21. Do not use the vehicle frame as the earth return. Any electrical low-resistance connection to the frame is a safety risk and is not allowed by international safety standards.
22. It is the responsibility of the installer to specify a battery charger that is suitably adapted to handle the charging voltage drop created by the combined resistance of the controller, cabling and connectors used in a particular vehicle configuration.
23. If the vehicle loses electric power, it is important that an attendant is able to move the vehicle easily.
24. After you have completed the installation, check it thoroughly. Correctly adjust all programmable options before the vehicle is used.
25. After you have configured the vehicle, test the vehicle to make sure that the vehicle performs to the specifications entered in the programming procedure. Check that the vehicle drives safely and that the performance of the vehicle is appropriate to the capabilities and needs of the user. If the vehicle does not perform as intended, reprogram the vehicle and test again. Repeat this procedure until the vehicle performs as intended. If the intended performance and/or operation cannot be reached, contact your service agent.
26. After maintenance or service of the vehicle, check the functional operation of all components that are externally connected to the controller, such as
 - lights
 - external switches
 - actuators
 - DCI/ACI/OBC resistor switch circuits (including programmed slowdown behaviour)
27. The dealer, therapist or other agent who supplies the vehicle to the end user has the responsibility to make sure that the vehicle is correctly configured for the needs and ability of that user.
28. For each individual user, the vehicle set up and configuration should take into consideration his or her

- technical knowledge, experience and education, and
 - medical and physical condition, including the level of disability and capability (where applicable).
29. It is the responsibility of the OEM and installer to make sure that the maximum driving speed of the vehicle is limited as appropriate when the vehicle is in a mechanically unstable position, for example when the seat is raised.
 30. The display (if present) must be visible to the user in all seating positions.
 31. It may be possible to set up the vehicle seating in such a way that users cannot operate the controls in every position. For example, if the seat is tilted backward, it may not be possible for some users to reach the controls. Make sure that the user has alternative means of operating the seating until the seat is back in a seating position that is suitable for the use of the standard controls.
 32. It is the responsibility of the therapist/ installer to minimise any risk of use error, including those arising from ergonomic features and/or the environment in which the device is intended to be used.
 33. Prior to handing over the vehicle, make sure that users are fully able to operate the product by giving them appropriate training on functionality and safety features, and having them test-drive the vehicle in a safe area in the presence of their agent.

6.8 Electromagnetic Compatibility (EMC)

DYNAMIC CONTROLS Electronic controllers and accessories have been tested on typical vehicles to confirm compliance with the following appropriate EMC standards:

USA: ANSI/RESNA WC-2: 2009 Sec 21

Europe: EN12184: 2014, ISO7176 - 21: 2009

National and international directives require confirmation of compliance on particular vehicles. Since EMC is dependent on a particular installation, each variation must be tested.

Minimising emissions

To minimise emissions and to maximise the immunity to radiated fields and ESD, follow the General Wiring Recommendations in section 3.2.2 of this manual.

6.9 Environmental statement



This product has been supplied from an environmentally aware manufacturer.

Please be environmentally responsible and recycle this product at the end of its life through your local recycling facility.

This product may contain substances that could be harmful to the environment if disposed of into a landfill.

Do not dispose of this product in fire.

See also: <http://www.dynamiccontrols.com/designers-and-manufacturers/compliance>

EUROPE

Ph: +44-1562-826-600

Fax: +44-1562-824-694

eusales@dynamiccontrols.com

ASIA

Ph: +886-955-335-243

Fax: +886 225-981-562

asiasales@dynamiccontrols.com

AUSTRALASIA (CORPORATE OFFICE)

Ph: +64-3-962-2519

Fax: +64-3-962-2966

sales@dynamiccontrols.com

USA

Ph: +1-440-979-0657

Fax: +1-440-979-1028

usasales@dynamiccontrols.com



Dynamic Controls is the world's leading manufacturer of electronic controls for power wheelchairs and scooters.

DYNAMIC was established in 1972 and is headquartered in New Zealand.
Regional centres are located in Europe, United States, Asia, and Australasia.

ISO 13485 certified –

DYNAMIC goes above and beyond industry standard expectations to ensure customers receive the best products possible.