



C.T.M. MOBILITY SCOOTER

HS-328 Instruction Booklet



TABLE OF CONTENTS

INTRODUCTION	1
IMPORTANT PRECAUTIONS	2
SAFETY INFORMATION ON ELECTROMAGNETIC INTERFERENCE (EMI)	3
IDENTIFICATION OF PARTS	5
CHARGING THE BATTERIES	9
DISASSEMBLING YOUR SCOOTER	10
TROUBLESHOOTING	11
CARE AND MAINTENANCE	12
CAUTION	13
SPECIFICATION	14

INTRODUCTION

Thank you and congratulations on purchasing your new C.T.M. Mobility Scooter. It is designed to provide you with transportation ability indoors and outdoors.

We pride ourselves on providing safe and comfortable products. Our goal is to ensure your complete satisfaction. We sincerely hope you enjoy your C.T.M. Mobility Scooter.

Please read and observe all warnings and instructions provided in owner's manual before you operate the various functions of this scooter. Also, please retain this booklet for future reference.

If you have any question, you can contact :

CHIEN TI ENTERPRISE CO., LTD.

No. 13, Lane 227, Fu Ying Rd., Hsin Chuang District,
New Taipei City, Taiwan, R.O.C.

Tel : +886-2-2903-2987 Fax : +886-2-2903-8807

E-Mail : sales@chienti.com.tw [http : //www.chienti.com.tw](http://www.chienti.com.tw)

Information of European Representative :

EMERGO EUROPE

Molenstraat 15

2513 BH, The Hague

The Netherlands

IMPORTANT PRECAUTIONS

- Only one person at a time could ride a C.T.M. Mobility Scooter.
- Maximum load is 136 kg / 300 lbs pounds.
- Turn key off before getting on or off.
- Always drive carefully and be aware of others using the same area.
- Always use pedestrian crossings wherever possible. Take extreme care when crossing roads.
- Do not drive on slope exceeding 8 degree, and take extreme care when turning on slope.
- Do not use full power when turning to sharp corner.
- Take great care and drive in low speed when backing up, riding downhill or on uneven surface, and climbing curb.
- Please use the lowest speed when driving through the descending road or uneven terrain. If speed is too fast, leave your hand off the handle bar, let the scooter stop. Make sure safety and start again.
- The weight capacity limit at different ramp degree (please refer to following picture).

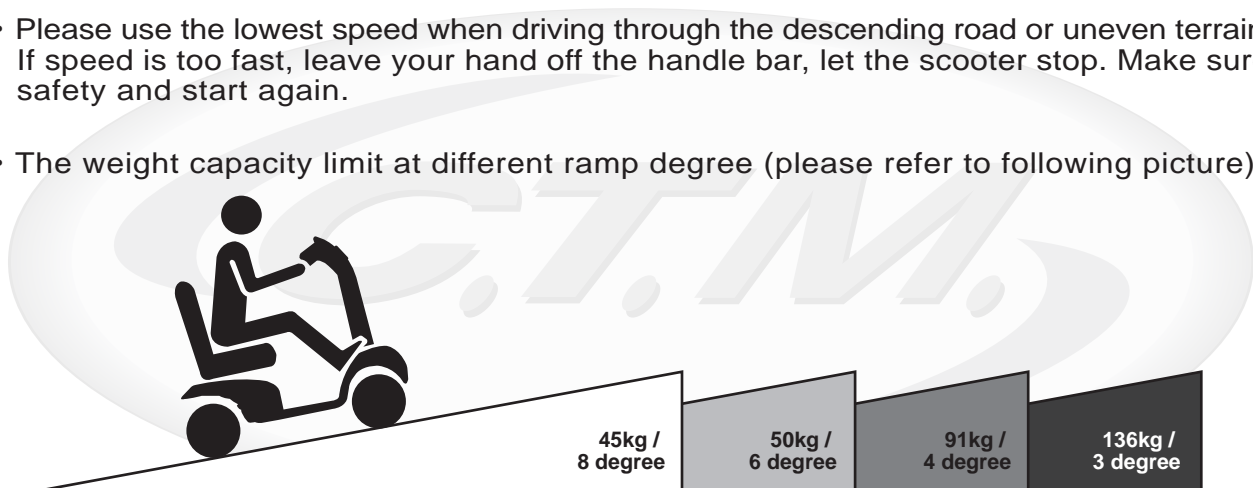

- The grade climbing degree will be affected by weight capacity, driving speed, and ramp degree, and scooter parameter.
- To prevent any danger from motor defected; please avoid to drive on long ramp or any uneven terrain.

- A slow speed must always be used when ascending, descending or traversing aslope or incline and also on uneven terrain, ramps and soft or loose surfaces, such as gravel or grass.
- To prevent any danger, do not turn around at high speed on ascending, descending ramp.
- Scooter may not operate well in high humidity.
- Do not leave the powered scooter in a rain storm of any kind.
- Do not use the powered scooter in a shower.
- Direct exposure to rain or dampness will cause the scooter to malfunction electrically and mechanically; may cause the powered scooter to prematurely rust.
- Never put scooter in neutral when staying on slopes.
- Follow traffic laws when riding outside.
- When scooter on moving transport vehicles, do not sit or stay on scooter.

SAFETY INFORMATION ON ELECTROMAGNETIC INTERFERENCE (EMI)

CAUTION : It is very important that you read this information regarding the possible effects of Electromagnetic Interference on your motorized scooter.

Powered wheelchairs and motorized scooters may be susceptible to electromagnetic interference (EMI), which is interfering electromagnetic energy (EM) emitted from sources such as radio stations, TV stations, amateur radio (HAM) transmitters, two-way radios, and cellular phones. The interference (from radio wave sources) can cause the motorized scooter to release its brakes, move by itself, or move in unintended directions. It can also permanently damage the motorized scooter control system. The intensity of the interfering EM energy can be measured in volts per meter (V/m). Each motorized scooter can resist EMI up to certain intensity. This is called its "immunity level." The higher the immunity level, the greater the protection. At this time, current technology is capable of achieving at least a 20 V/m immunity level, which would provide useful protection from the more common sources of radiated EMI. This immunity level of this motorized scooter model is 20 V/m.

There are a number of sources of relatively intense electromagnetic fields in the everyday environment. Some of these sources are obvious and easy to avoid. Others are not apparent and exposure is unavoidable. However, we believe that by following the warnings listed below, your risk to EMI will be minimized.

The sources of radiated EMI can be broadly classified into three types :

1. Hand-held portable transceivers (transmitters-receivers) with the antenna mounted directly on the transmitting unit. Examples include: citizens band (CB) radios, "walkie talkie," security, fire, and police transceivers, cellular telephones, and other personal communication devices;



Some cellular telephones and similar devices transmit signals while they are ON, even when not being used.

2. Medium-range mobile transceivers, such as those used in police cars, fire trucks, ambulances, and taxis. These usually have the antenna mounted on the outside of the vehicle; and
3. Long-range transmitters and transceivers such as commercial broadcast transmitters (radio and TV broadcast antenna towers) and amateur (HAM) radios.



Other types of hand-held devices, such as cordless phones, laptop computers, AM/FM radios, TV sets, CD players, and cassette players, and small appliances, such as electric shavers and hair dryers, so far as we know, are not likely to cause EMI problems to your motorized scooter.

Motorized Scooter Electromagnetic Interference :

Because EM energy rapidly becomes more intense as one move closer to the transmitting antenna (source), the EM fields from hand-held radio wave sources (transceivers) are of special concern. It is possible to unintentionally bring high levels of EM energy very close to the motorized scooter control system while using these devices. This can affect motorized scooter movement and braking. Therefore, the warnings listed below are recommended to prevent possible interference with the control system of the motorized scooter.

Warnings :

Electromagnetic interference (EMI) from sources such as radio and TV stations, amateur radio (HAM) transmitters, two-way radios, and cellular phones can affect motorized scooters. Following the warnings listed below should reduce the chance of unintended brake release or motorized scooter movement which could result in serious injury.

1. Do not operate hand-held transceivers (transmitters-receivers), such as citizens band (CB) radios, or turn ON personal communication devices, such as cellular phones, while the motorized scooter is turned ON;
2. Be aware of nearby transmitters, such as radio or TV stations, and try to avoid coming close to them;
3. If unintended movement or brake release occurs, turn the motorized scooter OFF as soon as it is safe;
4. Be aware that adding accessories or components, or modifying the motorized scooter, may make it more susceptible to EMI; and



There is no easy way to evaluate their effect on the overall immunity of the motorized scooter.

5. Report all incidents of unintended movement or brake release to the distributor listed on the inside front cover of this manual. Note whether there is a source of EMI nearby.

Important Information :

1. 20 volts per meter (V/m) is a generally achievable and useful immunity level against EMI (as of May 1994). The higher the level, the greater the protection.
2. The immunity level of this product is 20 V/m.

IDENTIFICATION OF PARTS

Before attempting to drive this scooter on your own, it is important that you familiarize yourself with the controls, and how to operate them.



Figure 1 - HS-328 Front View

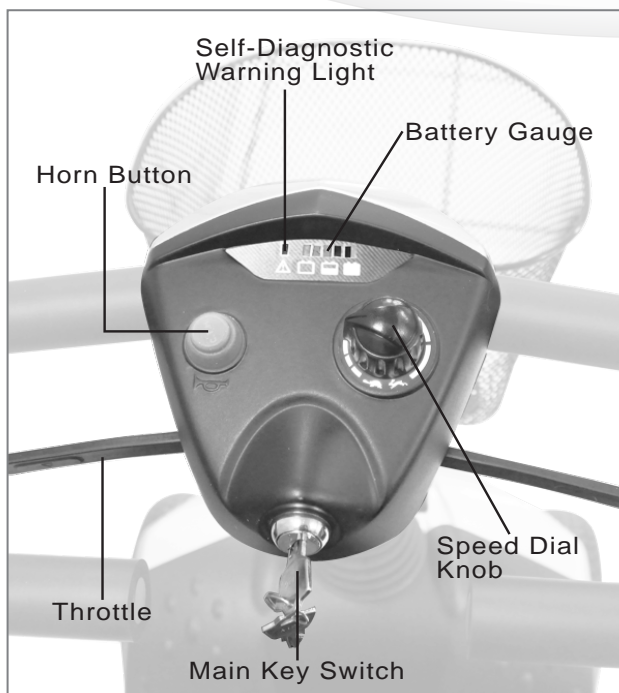

Figure 2 - HS-328 Top Control Panel

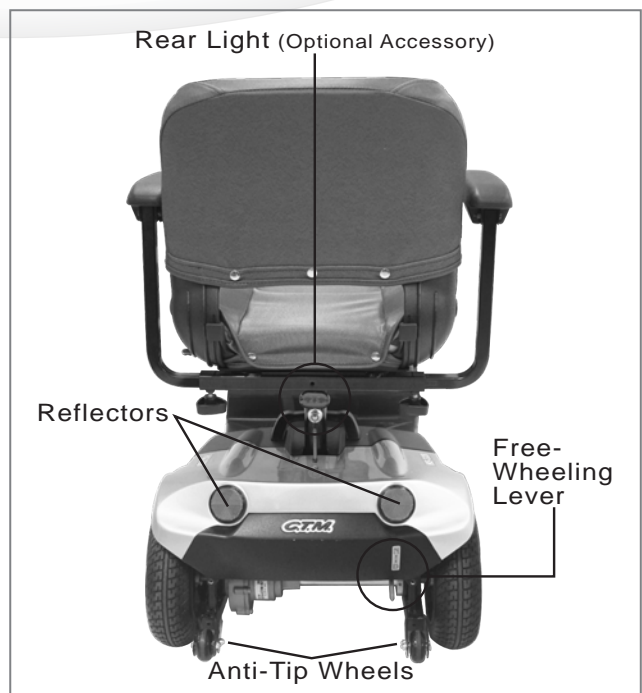

Figure 3 - HS-328 Back View

Before operation, please remove the Lock Nut (A) and press button of Circuit Breaker (B) to activate the system.

FUNCTION OF PARTS :

Main Key Switch (C)

1. Turn the key to the right
Turn the scooter on.
2. Turn the key to the left
Turn the scooter and LED headlight on.
3. Turn the key to the center position
Turn the scooter off.

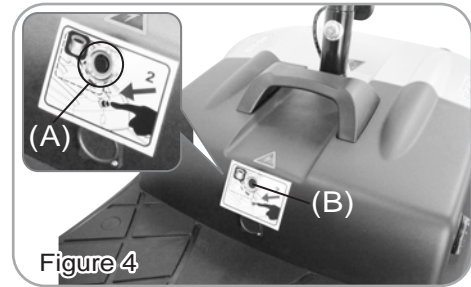
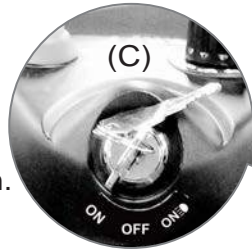

Figure 4

Always ensure that the scooter is switched off before getting on or off the scooter and before removing any items of the scooter.

Turning the scooter OFF whilst driving will bring the scooter to an abrupt stop

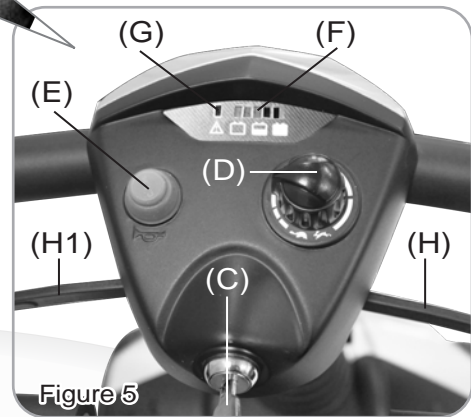

Figure 5

Speed Dial Knob (D)

The rabbit icon indicates fast or high speed. The turtle icon indicates slow or low speed. By turning this Knob (D) towards chosen icon you can control overall speed of the scooter.

Before driving the scooter, set the speed to low speed by turning the knob towards turtle icon.

Drive in high speed when encounter an up slope, and drive in low speed when encounter a down slope.

Horn Button (E)

Press Horn Button (E) once to sound warning tone when necessary.

Battery Gauge (F)

The LEDs represents an approximation of battery capacity. If the charge is full, all LEDs are lit. When only red and orange LEDs are lit, the batteries are consuming and should be charged soon. When only red LEDs are lit, charge the batteries immediately.

Self Diagnostic Warning Light (G)

Flashing light indicates there is a problem within scooter. See page 11 for more information.

Throttle (H) (H1)

To move forward by pulling the right side of Throttle (H). To move backward by pulling the left side of Throttle (H1). (The movement directions can be reversed by local dealers if required.) Releasing the throttle to engage automatic brake. These are also your accelerator, the further you pull it, the faster you go. (Subject to the position of the Rabbit/Turtle control).

Releasing the throttle engages the automatic brake, but will taxi for a short buffering distance, please keep safe distance when stopping to prevent any danger.

Tiller Angle Adjustment :

1. Turn the Cap (I) outward upward to disengage the pin.
2. Simultaneously, adjust the tiller fore-and-aft to the most comfortable angle. Release Cap (I) and ensure the pin is fully engaged to lock the tiller in position.

Seat Rotation Adjustment :

1. Lift the Lever (J) upward to disengage the pin.
2. Simultaneously, rotate Seat (K) to the most comfortable angle.
To lock the seat in position by Releasing Lever (J) and ensure the pin is fully engaged.

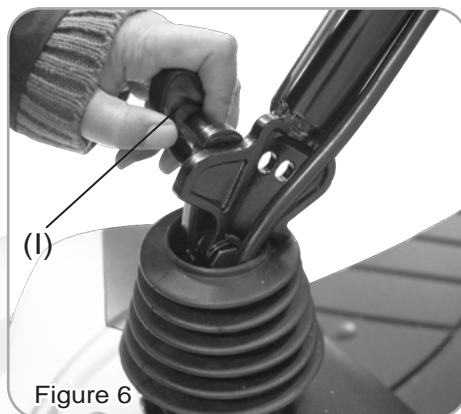
**Circuit Breaker :**

If scooter's circuit system malfunctions or over loaded, the circuit breaker will trip and automatically shut down the power to ensure driver's safety. After shut down the power, press button of Circuit Breaker (B) to reactive the circuit system.

Free-Wheeling Lever :

The scooter can be pushed, when the Free-Wheeling Lever (L) is disengaged.
To engage the Free-Wheeling Lever (L) - Pull up the free-wheeling lever.
To disengage the Free-Wheeling Lever (L) - Push down the free-wheeling lever.

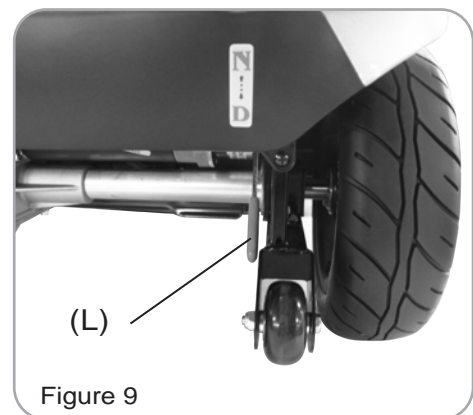
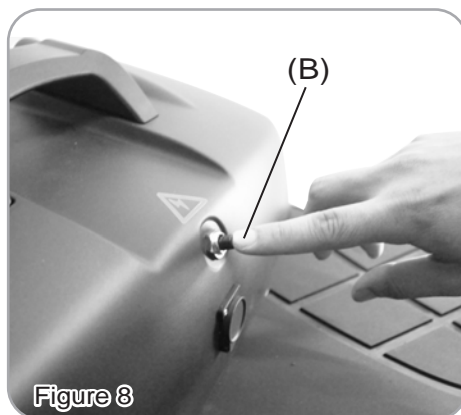

Basket assembling and disassembling :

- 1.Place the Front Basket (M) to the bracket on the tiller.
- 2.Remove the Front Basket (M) and place it aside.

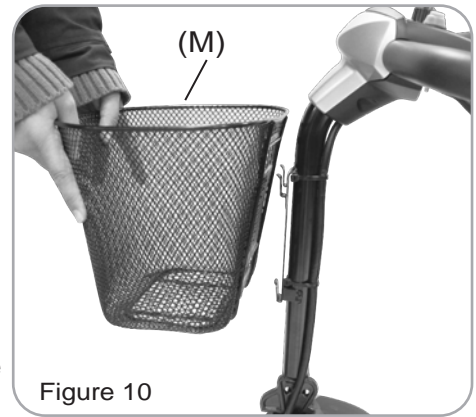

Figure 10

Armrest assembling and angle adjustment :

- 1.Adjust armrest to most comfortable length, then lock the Knob (N).
- 2.Adjust Screw (O) height to preferable armrest's angle



Figure 11

Seat Height adjustment :

- 1.Remove the seat, then screw, nut and washer from seat post.
- 2.Adjust seat post to desired height, then attached tightly with screw, nut and washers.
- 3.Assemble the seat back to its original position.
- 4.Seat height adjustability 520mm / 545mm / 570mm.



Figure 12

CHARGING THE BATTERIES

Your C.T.M. scooter is equipped with two sealed, maintenance free 12V. 22Ah. rechargeable batteries and one HS-328 24V/3A charger. Batteries must be charged before using scooter for first time and should be recharged after each day's use. Be sure power switch is in OFF position and free-wheeling lever is not in freewheel mode.

For safety reasons, only sealed non-spillable batteries that meet DOT CFR 173.159(d), IATA Packing Instructions, and IATA Provision A67 shall be installed in the scooters. If you need new batteries, contact your dealer. Only 12V. 22Ah Valve-regulated Lead Acid batteries should be used.

1. Insert battery charger cord into Charging Socket (P) on battery pack.

2. Plug other end of Power Cable (Q) into a standard electrical wall outlet.

3. LED Indication

LED (Power) - RED Light on : Power on

LED (Charge) - ORANGE Light on : Charging

GREEN Light on : Fully charged

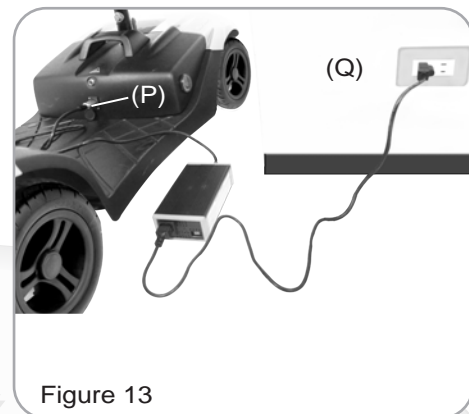

Figure 13

4. Allow batteries to charge until charging indicator turns green.

5. After indicator turns green, unplug battery charger from scooter and wall outlet.

6. If at any time battery charger light flashes green over 40 minutes, this indicates abnormal charging occurred.

You should check the following :

- Charger plug is correctly positioned
- Scooter is turned off
- If none of these are the problems, contact your local authorized dealer.



The time needed to recharge will vary depending on the depletion of the batteries. Charging for longer than necessary will not harm the batteries. They can not be overcharged.

Keep in mind these rules :

- Fully charge batteries at least once a month, or more if you use scooter regularly. Charge after each trip exceeding 3 kilometers.
- If storing your scooter for some time (1 month or more), make sure that batteries are fully charged, and on returning, charge them again before using scooter.
- Batteries will only give maximum performance after scooter has been used, and batteries have been recharged up to 10 times. A bit like breaking in a new car.

Please be aware that the travelling range of your mobility scooter is impacted by how fast the batteries are discharged. This will depend on many circumstances, such as ambient temperature, condition of the surface of the road, tyre pressure, weight of the driver, driving environment (inclines etc.) and utilisation of your lighting system if fitted. We recommend that you test your local ride with a family member to ensure a safe journey.

DISASSEMBLING YOUR SCOOTER

I. Seat Disassembling :

Remove seat by lifting Seat Rotation Lever (J). Then rotate Seat (K) and lift up away from scooter.

II. Battery Pack Disassembling :

As indication, pull Battery Pack Handle (R) to remove Battery Box (S) from scooter.
 Caution : Battery Box is heavy. When lifting, please use correct lifting posture to avoid injury. Ask for assistance if necessary.



When assembling battery pack (S), make sure to aim for the battery terminal connection for proper electricity conductivity.

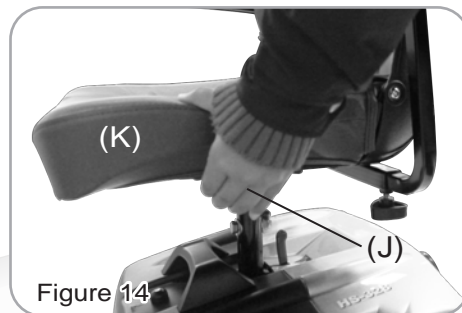

Figure 14



Figure 15

III. Front & Rear Frame Disassembling :

Hold front & rear frame with Release Lever (T) to disassemble front and rear frame.



Figure 16



Figure 17

Tiller Fold Method :

Turn the Cap (I) to fold down the Tiller (U) to the lowest position as shown in Figure 18. When the Tiller (U) is in the lowest position it can be locked by the pin of tiller angle adjustment.

Completion of Disassembling:

The Scooter can be disassembled into 7 main parts as shown in Figure 19.

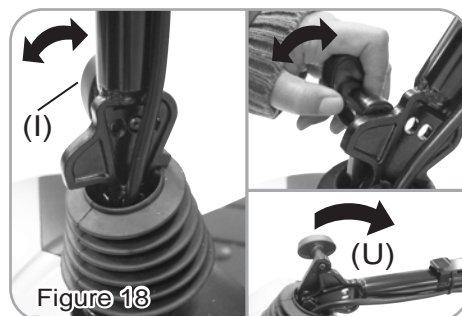

Figure 18

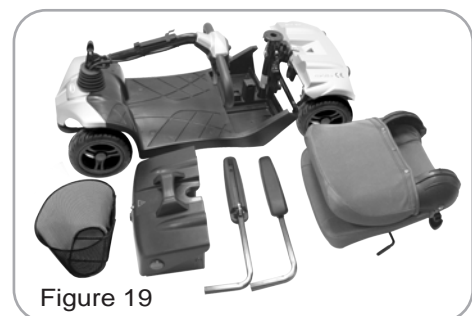

Figure 19



Re-assembling your scooter by vise versa above disassembling procedures.

TROUBLESHOOTING

Flash	Description	Meaning
1	Battery Low	The batteries are running low. <ul style="list-style-type: none"> • Recharge the batteries
2	Low Battery Fault	The batteries have run out of charge. <ul style="list-style-type: none"> • Recharge the batteries.
3	High Battery Fault	Battery voltage is too high. This may occur if overcharged &/or traveling down a long slope. <ul style="list-style-type: none"> • If traveling down a slope, reduce your speed to minimize the amount of regenerative charging. • Check the battery and associated connections and wiring.
4	Current Limit Time-out	The motor has been exceeding its maximum current rating for too long. This may be due to a faulty motor. <ul style="list-style-type: none"> • Check the motor and associated connections and wiring. • Turn the controller off, leave for a few minutes and turn back on again.
5	Park Brake Fault	Either a park brake release switch is active or the park brake is faulty. <ul style="list-style-type: none"> • Check the park brake and associated connections and wiring. • Ensure any associated switches are in their correct positions.
6	Throttle OONAPU	The Throttle is out of neutral when turning the controller on. <ul style="list-style-type: none"> • Ensure the throttle is in neutral when turning the controller on. • The Throttle may require re-calibration.
7	Speed Pot Fault	The throttle, speed limit pot or their associated wiring may be faulty. <ul style="list-style-type: none"> • Check the throttle and speed pot and associated connections and wiring.
8	Motor Voltage Fault	The motor or its associated wiring is faulty. <ul style="list-style-type: none"> • Check the motor and associated connections and wiring.
9	Other error	The controller may have an internal fault. <ul style="list-style-type: none"> • Check all connections & wiring.

CARE AND MAINTENANCE

Recommended maintenance procedures :

1. Before using the mobility scooter, make sure all nuts and bolts are tighten. Check any parts for damage or wear and replace it if needed. Check all parts for correct placements and adequate adjustments.
2. Ensure that batteries are well maintained and charged as instructed in page nine in this manual.
3. The wheels and tires should be checked periodically for cracks and wear, and should be replaced by a qualified technician.
4. Regularly check for loose nuts and/or bolts in the front and drive wheels. If loose, have them adjusted by a qualified technician.
5. Clean dirt, dust and grease from exposed components.
6. Periodically have the bearings of the front wheel checked to make sure they are clean and free from rust or moisture hazards.

Cleaning your mobility scooter :

Before cleaning the mobility scooter, be reminded the following tips:

- Only use a damp cloth and gentle detergent.
- Do not apply any abrasive or acidic substances during cleaning of scooter, to avoid damages to scooter.
- Do not use high-pressure hose and pipe to clean your scooter.
- Do not allow any direct contact with water for all of the electrical parts of this scooter.

CAUTION**1. Obstacle Climbing :**

Your scooter can climb obstacles and curbs of up to 40mm / 1.6" in height. Never attempt to overcome an obstacle when on an uphill or downhill gradient!

Always approach obstacles straight on! Ensure that the front wheels and rear wheels move over the obstacle in one stroke, do not stop halfway!

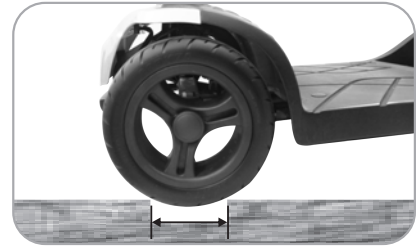
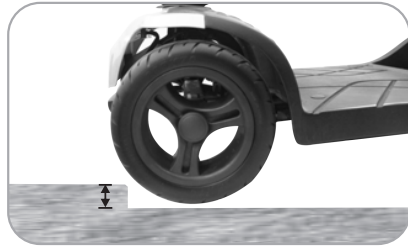
2. The maximum gap the scooter can drive over is 100mm / 4",

- When driving scooter on ramp, adjust body center of gravity to keep scooter more safety.



General driving posture



On ramp, forward your body will let scooter more safety.

Others :

1. Charge the batteries after each trip. If the scooter is not used for some time, batteries may lose their charge. Batteries should be charged at least once a month.
2. Check the battery gauge before driving to prevent power depletion.
3. Batteries will have an aging phenomenon, where the storage capacity will gradually decrease. If batteries are damaged, please wrap them in a plastic bag and contact your local dealer for proper disposal.
4. Do not disassemble battery and open sealed parts by yourself to prevent electric shock and burns from acid leakage,
5. Adjust speed to a slow speed when starting off to prevent sudden acceleration.
6. Never attempt to drive downhill backwards.
7. Try not to drive scooter at night or in rain or bad weather.
8. If storing your scooter for a long time (1 month or more), make sure that battery are fully charged, then disconnect the two batteries plugs (W), and store the scooter in a dry location.
9. Front basket, weight capacity 3kgs (6.5lbs).

SPECIFICATION

Overall Length	1120 mm / 44"
Overall Width	590 mm / 23"
Overall Height	935 mm / 37"
Front Wheels	225 mm / 9"
Rear Wheels	225 mm / 9"
Weight W/ Batteries	55 kg / 121 lbs
Weight Of Heaviest Piece	17.4 kg / 38 lbs
Max. Speed	8 kmph / 5 mph
Weight Capacity	136 kg / 300 lbs
Ground Clearance	52 mm / 2"
Grade Climbable	8 degree
Curb Climbable	40 mm / 2"
Turning Radius	1450 mm / 57"
Suspension	Rear (Option)
Brake	Electro-Mechanical
Seat Type	Swivel Light Weight Foldable
Seat Width	460 mm / 18"
Motor Size	250W, 4000 r.p.m
Battery Size	(2) 12V. 22Ah
Battery Weight	15.5 kg / 34 lbs
Travel Range	17.5 km / 11 Miles
Battery Charger	3A Off Board
Electronics	On / Off Key Switch, Battery Level Indicator, Speed Control Knob

*Subject to change without notice. (Issue B 24/05/2016)