

karma

A Better Wheelchair, A Better Fit

Powered Wheelchair Owner's Manual

KP-25.2 Series



CE

GENERAL WARNING

IMPORTANT

Do not attempt to use the wheelchair before a qualified person has explained to your satisfaction how to operate it without risk to yourself or others.



WARNING

- Do not operate this powered wheelchair before first reading and understanding this owner's manual. If you are unable to understand the warnings, cautions, suggestions and technical instructions, please contact a dealer, healthcare professional or applicable personnel before attempting to use this power wheelchair -- otherwise, injury or damage may occur. If any procedures other than those described in this owner's manual, it MUST be performed by a qualified technician.

THE INFORMATION CONTAINED IN THIS DOCUMENT IS SUBJECT TO CHANGE WITHOUT NOTICE BY KARMA.



WARNING

- As a manufacturer of powered wheelchairs, KARMA endeavors to supply a wide variety of powered wheelchairs to meet the many needs of the user. However, the responsibility of final selection of the type of powered wheelchair to be used by an individual rests solely with the user and his/her healthcare professional capable of making such a selection. KARMA strongly recommends consulting a certified rehab technology supplier or assistive technology professional.

It is the responsibility of the Durable Medical Equipment (DME) Dealer, therapists and other healthcare professionals to determine if a seat positioning strap is required to ensure the safe operation of this equipment by the user. Serious injury can occur in the event of a fall from a powered wheelchair.

Operating Information

- Performance adjustments should ONLY be made by professionals of the

healthcare field or persons fully conversant with this process and the driver's capabilities. Incorrect settings could cause injury to the driver or bystanders and damage to the powered wheelchair and surrounding property.

- To determine and establish your particular safety limits, practice bending, reaching, mounting and dismounting activities in several combinations in the presence of a qualified healthcare professional BEFORE attempting active use of the powered wheelchair.
- For individuals with balance problems, practice mounting and dismounting activities WITH AN ASSISTANT in the presence of a qualified healthcare professional.
- If so equipped, DO NOT operate the wheelchair without anti-tippers being installed. Anti-tippers MUST BE attached at all times
- DO NOT attempt to reach objects if you have to move forward in the seat or pick them up from the floor by reaching down between your knees as this may cause loss of balance.
- DO NOT lean over the back of the chair to reach objects behind you as this may cause the powered wheelchair to tip over.
- DO NOT shift your weight or sitting position toward the direction you are reaching as the powered wheelchair may tip over.
- DO NOT use an escalator to move a powered wheelchair between floors. Serious bodily injury may occur.
- DO NOT operate in car lanes on roads, streets, highways, etc.
- DO NOT attempt to move up or down an incline with a water, ice or oil film.
- DO NOT attempt to ride over curbs or obstacles. Doing so may cause your powered wheelchair to turn over and cause bodily harm and/or damage to the powered wheelchair.
- DO NOT make sharp turns, in forward or reverse, at excessive speeds.
- DO NOT attempt to lift the powered wheelchair by its casings and seat.
- DO NOT attempt to lift the powered wheelchair by any detachable parts. Lifting by means of any detachable parts of a powered wheelchair may result in injury to the user or damage to the powered wheelchair. Please hold onto the frame when lifting your wheelchair.
- DO NOT operate the powered wheelchair until you have checked that the surroundings are clear and that the area is safe for travel.
- Please pay attention to the environment, and to keep away from the hazard of external flame. When the user is smoking, pay attention to safety and make sure to extinguish the fire when finished. Be alert to the environment when someone nearby is smoking or using a cigarette lighter, keep away from the hazard and use fire-proof cloth.
- DO NOT use parts, accessories or adapters other than those authorized by Karma. Before attempting to sit in or exit the power wheelchair, turn the power OFF. This will ensure that the power wheelchair will not drive. Turn the power OFF while the wheelchair is not in use. Otherwise, injury and/or damage to the wheelchair and surrounding property may occur
- DO NOT connect any medical device (i.e., a ventilator, life support machine, et

cetera) to the battery. This could cause unexpected failure of the device and the powered wheelchair. KARMA specifically disclaims responsibility to all personal injury and property damage that may occur during use which does not comply with applicable federal, state and local laws and ordinances.

- DO NOT stand on the footplates of the powered wheelchair.
- DO NOT use the wheelchair when the back is folded. This alters the centre of gravity and may cause the wheelchair to tip backwards. The back should only be folded for storage or transport of the wheelchair.
- DO NOT hang anything on the backjoints that could cause the backrest folding suddenly and may cause injury.
- DO NOT be towed by other vehicles(cars, motorcycles or bicycles, etc.). Only use freewheel mode on flat surfaces since your electromagnetic brakes are not engaged in this mode, without these brakes it will roll down a hill causing injury or damage. Never drive under the influence of alcohol or medication.
- **DO NOT** sit in the powered wheelchair within a moving vehicle unless it has been affixed the labels of hook mark. The labels of hook mark means that the powered wheelchair fulfils the performance requirements for a “Crash Test” of ISO 7176-19 and is suitable to use as a seat in vehicles that have been adapted for this purpose.



WARNING

- **Please transfer to a seat in the car if at all possible.**

Ramps

- DO NOT climb, go up or down ramps or traverse slopes greater than the Max Safe Slope for your model specified in Section 10.
- When negotiating ramps, if the joystick is released while moving forward, the powered wheelchair will roll backwards approximately one foot before the brake engages. If the joystick is released while in reverse, the powered wheelchair will roll backwards approximately two and a half feet before the brake engages.
- Be sure to reduce your speed when driving on curved roads or making a turn; do not drive at full speed. Please drive at a slower speed so you have complete control of the wheelchair.

Electrical

- Check to ensure that all electrical connections are secure at all times.
- Grounding Instructions: DO NOT, under any circumstances, cut or remove the round grounding prong from any plug. Some devices are equipped with three-prong (grounding) plugs for protection against possible shock hazards.
- Where a two-prong wall receptacle is encountered, it is the personal responsibility and obligation of the customer to contact a qualified electrician and have the two-prong receptacle replaced with a properly grounded three-prong wall receptacle/outlet in accordance with the National Electrical Code and local laws.
- Do not use a n extension cord when charging your batteries. A risk of fire and /or

electric shock could be encountered.

Batteries

- The warranty and performance specifications contained in this manual are based on the use of deep cycle sealed lead acid batteries.
- KARMA strongly recommends their use as the power source for this unit. (Refer to Section 6)
- Carefully read the battery and charger information prior to installing, servicing or operating your wheelchair.

Rain Test

- DO NOT leave your powered wheelchair in a rain storm of any kind.
- DO NOT use your powered wheelchair in a shower or leave it in a damp bathroom while taking a shower.
- DO NOT leave your powered wheelchair in a damp area for any length of time. Direct exposure to rain or dampness could cause the powered wheelchair to malfunction electrically and mechanically and may cause the powered wheelchair to prematurely rust.

Stairways

- DO NOT attempt to move an occupied powered wheelchair between floors using a stairway. (See Figure 1)
- Use an elevator to move an occupied powered wheelchair between floors. If moving a powered wheelchair between floors by means of a stairway, the occupant **MUST** be removed and transported independently of the powered wheelchair. Extreme caution is advised when it is necessary to move an UNOCCUPIED powered wheelchair up or down stairs.
- Karma recommends disassembling the wheelchair and transporting the components independently up or down stairs. Make sure to use **ONLY** secure, non-detachable parts on each component for hand-hold supports.
- DO NOT attempt to lift a powered wheelchair by any removable (detachable) parts. Lifting by means of removable (detachable) parts may result in injury to the user or assistants or damage to the wheelchair.



(Figure 1)

Escalators

- DO NOT use an escalator to move a powered wheelchair between floors. Serious bodily injury and damage to the wheelchair may occur.

You and Your Karma Service Provider

- No tools are required for assembly. Your wheelchair should be assembled by your authorized Karma dealer. Your authorized Karma dealer is also your service

-
- provider. Unauthorized repairs, upgrades and add-ons will negate your warranty.
- Anything wheelchair related that requires tools should be done by your authorized Karma service provider. Your Karma service provider has the necessary service manual for your wheelchair.
 - If you have any defective parts or lose any parts, please contact your dealer for repair and/or replacement. Please only use parts authorized by Karma. Use of parts that are not authorized by Karma will negate your warranty.
 - Part numbers are listed on our bill of materials (explosion drawings), which we give to our authorized dealers and service providers. Customers should order parts through their dealer as well as all repairs and scheduled maintenance.
 - Customers should go to their dealership for all service needs to guarantee their warranty is not void. Always go to an authorized service provider. Unauthorized repairs will void your warranty. Procedures other than those described in this manual must be performed by a qualified technician. They also have the service manual with a complete list of maintenance required to keep your Karma wheelchair in top performance.
 - Check the warranty section of this manual to find out what Karma guarantees and what maintenance service and parts that are not covered by the warranty.
 - Karma does not have an official list of service providers at this time. Please contact your dealer for service. If you cannot contact your dealer, please contact another authorized Karma dealer for service. If all else fails, contact Karma directly via our website or give us a call and we can refer you to your new service provider.

CLASSIFICATION & INTENDED USE

- Karma's KP-25.2 are classified as a class B mobility product for indoor and outdoor use. This wheelchair is suitable for users up to 135kg/115kg(w/solid wheel) in weight. The KP-25.2 in Australia was tested for 125kgs conforms to AU/NZS. It also has an extremely durable aluminum alloy frame with tough accessory and does not suffer in dramatic extremes of temperature (neither user nor attendant need touch metal parts in normal use).
- Check with your local government as to legislation pertaining to mobility vehicles to assure your legal requirements to drive on public roads have been met, i.e. a pelvic belt, lighting, registration or licensing.

CE MARKING

- This powered wheelchair complies with the requirements of the Medical Devices Directive 93/42/EEC.



CAUTION

-
- Before purchasing and using Karma wheelchairs, please consult qualified professionals so as to ensure that you choose suitable products and use them correctly as well. For safety reasons, if there is any risk due to the user's movement in the wheelchair or other environmental factors that might cause the wheelchair to tip or the person on the wheelchair to fall off, Karma recommends that you install anti-tippers, pelvic belt, or other additional safety accessories.



WARNING

- When prescribing wheelchairs for use by full or partial amputees (above or below knee, single or double) or other conditions that affects the user's natural centre of gravity and might cause the wheelchair to tip or the person on the wheelchair to fall off, we suggest contacting your therapist or dealer as well as attaching anti-tippers, pelvic belt, safety belt, or other additional safety accessories.
- When using the wheelchair, ALWAYS follow the Highway Code or your local traffic regulations when outdoors and the guidelines written in this manual.

TABLE OF CONTENTS

1. PREFACE.....	1
2. SAFETY.....	2
2.1 Before Driving.....	2
2.2 Traffic Rules	2
2.3 Practice Driving.....	2
2.4 No Passengers.....	3
2.5 No Hauling Heavy Goods	3
2.6 Rain.....	3
2.7 While Driving	3
2.8 General Warning	3
2.9 Surface temperatures.....	3
2.10 Ignitability standards.....	3
2.11 Railroad Crossing.....	4
2.12 Circumstances to Avoid.....	4
2.13 Mobile Phones and Other Electric Equipment.....	4
2.14 Ramps, Inclines and Drops.....	4
2.15 Maximum User Weight Limit	5
2.16 KP-25.2 Labeling	7
3. EMI/RFI.....	8
3.1 Electromagnetic Interference From Radio Wave Sources	8
3.2 The sources of radiated EMI can be broadly classified into three types	9
3.3 Powered Vehicle Electromagnetic Interference (EMI)	10
3.4 Warnings	10
4. PARTS.....	12
5. OPERATION	14
5.1 VRII Joystick Controller	14
5.2 How to Operate Your wheelchair	14
5.3 Shark Controller (Optional)	16
5.4. Power ON/OFF	16
5.5 Speed Adjustment Button	17
5.6 Forward, Reverse and Braking.....	17
5.7 Driving Speed	17
5.8 To Stop.....	18
5.9 Horn Button.....	18
5.10 Battery Indicator	18

5.11	Unfolding the Chair	19
5.12	Folding the Wheelchair	19
5.13	Footrest Removal and Refitting	20
5.14	Armrest Flip-Back & Height Adjustment.....	20
5.15	Freewheel Levers	20
5.16	To Select Neutral from the Engaged Position.....	20
5.17	To Engage the Motors from the Neutral Position	21
5.18	Armrest Flip Up and Height adjustment.....	21
5.19	Getting In And Out.....	22
5.20	Getting In.....	22
5.21	Getting Out.....	22
5.22	Motor Brakes.....	23
5.23	Parking Brakes - Hand Operated.....	23
5.24	Install the Anti-Tippers	24
5.25	Transportation	24
5.26	Before use.....	25
5.27	Adjusting the length of the pelvic belt.....	27
5.28	How to Operate It.....	28
5.29	Maintenance.....	28
6.	BATTERIES AND CHARGER	28
6.1	Charging the Batteries	28
6.2	Charge Your Batteries If Any of the Following Conditions Occur	28
6.3	Be Sure To Follow the Procedures Listed Below Precisely	29
6.4	Charger	31
6.5	Batteries.....	32
6.6	Cleaning the Batteries	33
7.	INSPECTION AND MAINTENANCE	34
7.1	Daily Check.....	34
7.2	Regular Maintenance Record	35
7.3	Tires	36
7.4	General Maintenance	36
7.5	Suggested Maintenance Procedures.....	37
7.6	Transporting and Storing	38
8.	OPTIONAL ACCESSORIES.....	38
8.1	Cushion	38
8.2	Curb Climber	38
9.	TROUBLESHOOTING.....	40
9.1	VRII Controller, Battery & Diagnostics Indicator.....	40



10. SPECIFICATIONS.....	44
10.1 KP-25.2 Series Static Stability Test Result	45
11. CLEANING & RECYCLING	45
11.1 Cleaning	45
11.2 Post-Consumer Recycling.....	46
12. WARRANTY	47
12.1 Serial Number	47
12.2 Contents of Warranty.....	47
12.3 Warranty Duration and Parts Covered by the Warranty	47
12.4 Items Not Covered	47
12.5 Problems Not Covered	48
12.6 The Responsibilities of the User.....	49
12.7 Warranty Effectiveness	49
12.8 Transfer of Warranty Rights	49

1. PREFACE

Please carefully read this owner's manual before using the wheelchair. Improper use of the wheelchair could result in harm, injury or traffic accidents. Therefore, for safe and enjoyable use of the wheelchair, please read this owner's manual.

1.1 This owner's manual includes operation instructions for the aspects of the wheelchair, assembly instructions, and instructions on how to deal with possible accidents. This owner's manual is written for Karma powered wheelchair(s): KP-25.2.

1.2 The symbols used in this manual are explained below. Pay special attention to the parts marked with these symbols.

 WARNING	Improper use could lead the user to severe injury or death.
 CAUTION	Improper use could lead the user to severe injury and/or damage to your wheelchair.
 SUGGESTION	Follow these instructions to keep the wheelchair in good condition.

1.3 This manual includes the repair and maintenance chart as well as the Warranty. Please keep it in a safe place or with the wheelchair.

1.4 If someone else uses the wheelchair, make sure that you give him or her this owner's manual for his or her reference.

1.5 As designs change, some illustrations and pictures in this manual may not correspond to the vehicle that you purchased. We reserve the right to make design modifications without further notice.

2. SAFETY

2.1 Before Driving

2.1.1 The user must be familiar with the use and operation of this wheelchair before driving.

2.1.2 Therefore, please always keep these safety guidelines in mind.

2.2 Traffic Rules

2.2.1 Pedestrian traffic rules apply to this wheelchair. Please be safe.

2.2.2 Drive only on pedestrian areas such as the sidewalk. Never drive the wheelchair on the highway.

2.2.3 Be aware of other vehicles when crossing all roads.

2.2.4 Be extremely cautious when driving your wheelchair in heavy traffic or the shopping mall.

2.2.5 DO NOT drive your wheelchair when you feel tired or consume alcohol.

2.2.6 Please do not drive your wheelchair at night.

2.2.7 Please follow pedestrian traffic lights.

2.3 Practice Driving

2.3.1 Before you are familiar with the operation of your wheelchair please practice in a wide and open area, like a park.

2.3.2 To avoid falling off your wheelchair please practice all kinds of driving motions, such as accelerating, stopping, turning, reversing and going up and down ramps.

2.3.3 Please set the speed to medium when you first start practicing.

2.3.4 Be safe. Make sure someone accompanies you in case you need assistance.

2.3.5 Be sure you are able to control and operate your wheelchair easily and confidently before you move the speed higher.

2.4 No Passengers

KARMA wheelchair is limited to one driver. Do not carry passengers (including children) on your wheelchair.

2.5 No Hauling Heavy Goods

Do not use this wheelchair to carry or haul heavy goods. The maximum weight that can be carried, including goods, is stated beside "Max. User Weight" in section 10. SPECIFICATIONS.

2.6 Rain

This product is not guaranteed to be water resistant. Please do not drive in the rain, through puddles or spray water to clean this product. (See Figure 2.1)

2.7 While Driving

Please carry out daily inspections. Refer to section 7.1 DAILY CHECK.

2.8 General Warning

Do not lean over the side of the wheelchair as such an action may cause you to lose balance and fall.

Use caution to assure your clothing doesn't get tangled with the wheels.

2.9 Surface temperatures

Surface temperatures can increase if the product is exposed to direct sunlight.

2.10 Ignitability standards

In compliance with ignitability standards. A separate report for resistance to ignition of upholstered components may be available from the manufacturer or supplier if requested.

2.11 Railroad Crossing

Before crossing the tracks, please stop completely and look both ways.

Cross the tracks perpendicular to avoid your wheels getting stuck.

Do not drive at full speed over railroad tracks.

2.12 Circumstances to Avoid

2.12.1 Avoid roads with heavy traffic, mud, excessive gravel or bumps, snow and ice. These conditions may damage your wheelchair.

2.12.2 Avoid roads that are too narrow or by a canal/waterway without any fence/hedge.

2.12.3 Also avoid places where your wheels might get stuck, slip or not have traction.

2.12.4 Do not drive in a gale, at night or in rainy/snowy/foggy/misty weather.

These conditions may cause your wheelchair to rust. (See Figure 2.2)

2.12.5 Do not drive in a S curve, do doughnuts or make sudden turns.

2.12.6 Do not take an escalator.

2.13 Mobile Phones and Other Electric Equipment

2.13.1 Do not use a mobile phone or other wireless communication devices while driving. (See Section 3. EMI/RFI)

2.13.2 Do not charge the mobile phone or other electric devices from your wheelchair's batteries.

2.14 Ramps, Inclines and Drops

2.14.1 Do not drive onto a steep ramp. Refer to "Max. Climbing Ability" in Section 10. SPECIFICATIONS for your wheelchair's maximum climbing angle.

2.14.2 When climbing up to an inclined road, please set the speed higher than the medium speed and drive carefully. (See Figure 2.3)

2.14.3 When going down an inclined road, set the speed to "1" and never use reverse.

-
- 2.14.4 Do not drive on a road with many bumps and holes close to each other, such as potholes or washboard roads. (See Figure 2.4)
- 2.14.5 Do not make sudden turns when driving on gravel roads or ramps.
- 2.14.6 The maximum surmountable obstacle height is 5.5 cm for your wheelchair(with optional curb climber is up to 8 cm). Exceeding this obstacle height will damage your wheelchair and void your warranty. (See Figure 2.5)
- 2.14.7 When negotiating an obstacle slow down, put your seat into the full upright position and approach it head on (perpendicular).
- 2.14.8 Just before the obstacle, speed up until the entire wheelchair has conquered the obstacle. Negotiating an obstacle at an angle may cause your wheelchair to tip over. Don't do it!
- 2.14.9 When climbing down a curb, slow down just before you get to it and only speed up after the entire wheelchair has lowered to the road.
- 2.14.10 Again, descending obstacles should be done perpendicularly. (See Figure 2.6)
- 2.14.11 Karma does not design wheelchairs to take jumps over or off obstacles. Doing so will void your warranty.



WARNING

- Do not set the wheelchair in freewheel mode when on an incline or decline.
- If you breakdown on railroad tracks, first, check for an oncoming train. If a train is coming, get out of its way immediately! If no train is coming, set to freewheel mode and push the wheelchair off the tracks.

2.15 Maximum User Weight Limit

- 2.15.1 Refer to "Max. User Weight" in Section 10. SPECIFICATIONS.
- 2.15.2 Loading exceeding maximum capacity can damage your wheelchair and cause malfunctions yielding a safety hazard. The warranty does not cover damage caused by improper operation of the wheelchair.



(Figure 2.1)



(Figure 2.2)



(Figure 2.3)



(Figure 2.4)



(Figure 2.5)



(Figure 2.6)

2.16 KP-25.2 Labeling

Please carefully read all the labeling on the wheelchair before driving it. Do not remove them. Protect them for future reference.

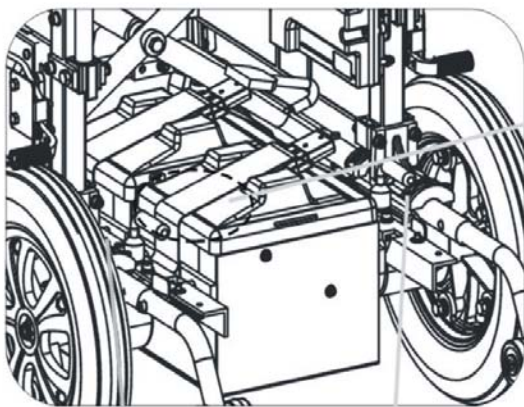

Back side

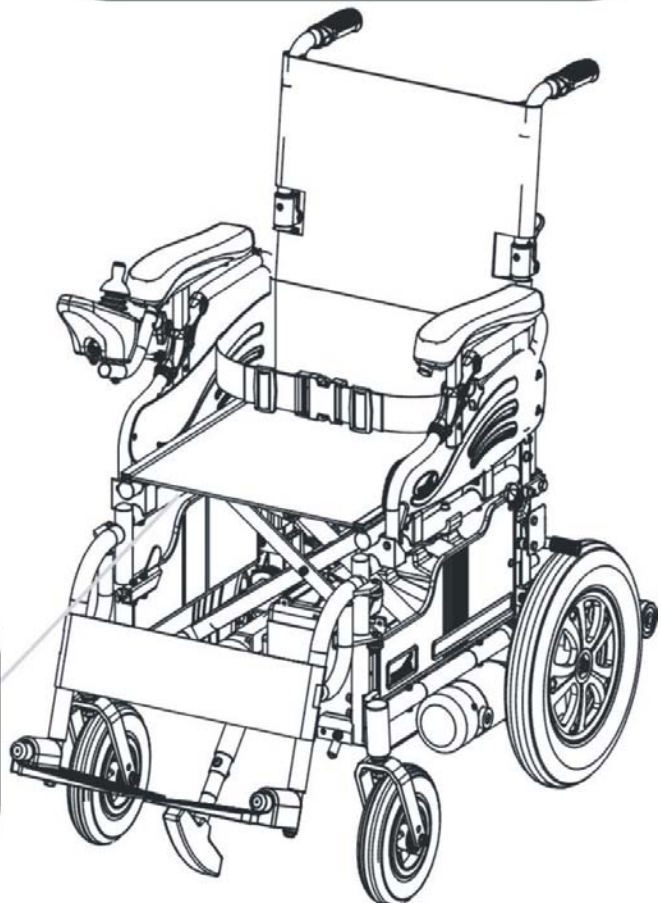
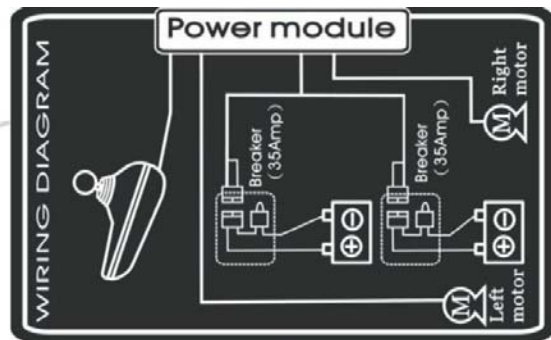

3. EMI/RFI

This section provides the user with basic information about the problems with EMI, known sources of EMI and protective measures either to reduce the possibility of exposure or to minimize the degree of exposure. This section also shows some conditions in which unexpected or erratic wheelchair movements may occur.



CAUTION

- It is very important that you read this information regarding the possible effects of electromagnetic interference on your electric KARMA wheelchair

3.1 Electromagnetic Interference From Radio Wave Sources

3.1.1 Powered vehicles may be susceptible to electromagnetic interference (EMI), which is interfering electromagnetic energy (EM) emitted from sources such as radio stations (Radio Frequency Interference), TV stations, amateur radio (HAM) transmitters, two-way radios, and cellular phones. The interference (from radio wave sources) can cause the powered vehicle to release its brakes, move by itself, or move in unintended directions. It can also permanently damage the powered vehicle's control system. The intensity of the interfering EM energy can be measured in volts per meter (V/m). Each powered vehicle can resist EMI up to a certain intensity. This amount of resistance is called its immunity level. The higher the immunity level, the greater the protection. At this time, current technology is capable of achieving at least a 20 V/m immunity level, which would provide useful protection from the more common sources of radiated EMI. This powered vehicle model, with no further modification, has an immunity level of 20 V/m without any

accessories.

3.1.2 There are a number of sources of relatively intense electromagnetic fields in our everyday environment. Some of these sources are obvious and easy to avoid. Others are not apparent and exposure could be unavoidable. However, we believe that by following the warnings listed below, your risk to EMI can be greatly minimized.

3.2 The sources of radiated EMI can be broadly classified into three types

3.2.1 Hand-held portable transceivers (transmitter-receivers) with the antenna mounted directly on the transmitting unit, such as citizens band (CB) radios, walkie-talkies, security and fire or police transceivers, cellular telephones and other personal communication devices;

NOTE:

Some cellular telephones or similar devices transmit signals while they are ON, even though they are not in use.

3.2.2 Medium-range mobile transceivers used in police cars, fire trucks, ambulances and taxis usually having the antenna mounted on the outside of the vehicle; and

3.2.3 Long-range transmitters and transceivers, such as commercial broadcast transmitters (radio and TV broadcast antenna towers) and amateur (HAM) radios.

NOTE:

Other types of hand-held devices (cordless phones, laptop computers, AM/FM radios, TV sets, CD players, cassette players, and small appliances such as electric shavers and hair dryers, et cetera) so far as we know, are not likely to cause EMI problems.

3.3 Powered Vehicle Electromagnetic Interference (EMI)

Because EM energy rapidly becomes more intense as one moves closer to the transmitting antenna (source), the EM fields from hand-held radio wave sources (transceivers) are of special concern. It is possible to unintentionally bring high levels of EM energy too close to the powered vehicle's control system while using these devices. This can affect your powered vehicle's movement and braking. Therefore, the warnings listed below are recommended to prevent possible interference with the control system of the powered vehicle.

3.4 Warnings

Electromagnetic interference (EMI) from sources such as radio and TV stations, amateur radio (HAM) transmitters, two-way radios and cellular phones can affect powered vehicles and motorized wheelchairs.

Following the warnings listed below should reduce the chance of unintended brake release or powered vehicle movement which could result in serious injury.

3.4.1 Do not operate hand-held transceivers-receivers such as citizens band (CB) radios or turn ON personal communication devices such as cellular phones, while the powered vehicle is turned ON.

3.4.2 Be aware of nearby transmitters, such as radio or TV stations, and try to stay away from them.

3.4.3 If unintended movement or brake release occurs, turn the powered vehicle OFF as soon as it is safe.



CAUTION

- **Some stores may have automatic (sensor) doors and alarm systems set at certain frequencies that might affect your powered wheelchair**

3.4.4 Be aware that adding accessories/components or modifying the powered vehicle may make it more susceptible to EMI. There is no easy way to evaluate their effect on the overall immunity of the powered vehicle.

3.4.5 Report all incidents of unintended movement or brake release to your powered vehicle dealer or KARMA, and note whether there was a source of EMI nearby.

4. PARTS

KP-25.2

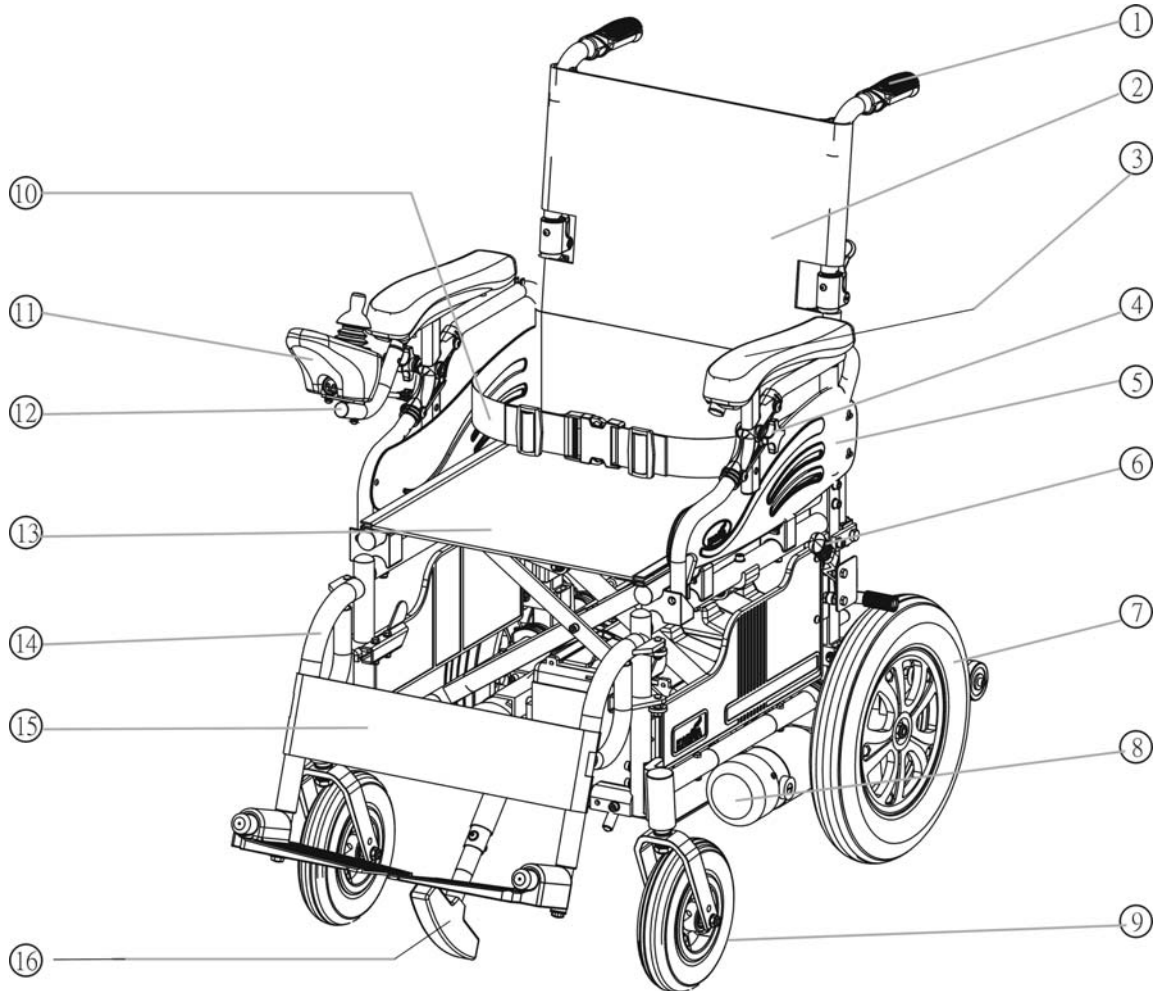

- | | |
|-----------------------------------|--------------------------------|
| 1. Push Hand | 9. Front Wheel |
| 2. Backrest | 10. Pelvic Belt |
| 3. Armrest | 11. Controller |
| 4. Armrest Height Adjustment Knob | 12. Controller Connection Tube |
| 5. Side Panel | 13. Seat |
| 6. Brake | 14. Footrest |
| 7. Rear Wheel | 15. Calf Strap |
| 8. Motor | 16. Curb Climber (Optional) |

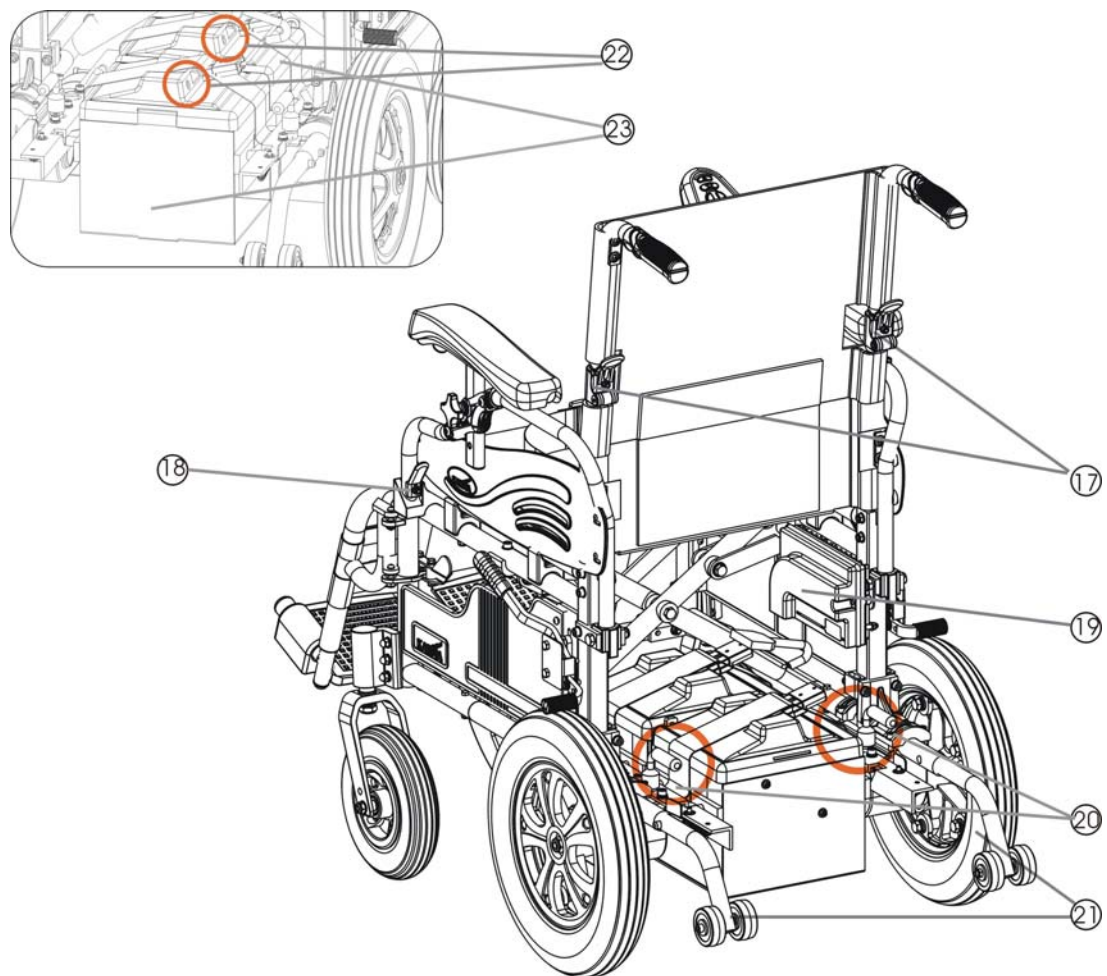

17. Back Joint

18. Armrest Release Base

19. Power Module

20. Freewheel Lever

21. Anti-tippers

22. Fuse

23. Battery

5. OPERATION

5.1 VRII Joystick Controller

- 5.1.1. Power ON/OFF
- 5.1.2. Joystick
- 5.1.3. Speed Adjustment Buttons
- 5.1.4. Battery & Diagnostics Indicator
- 5.1.5. Speed Indicator
- 5.1.6. Horn Button
- 5.1.7. Charging Socket

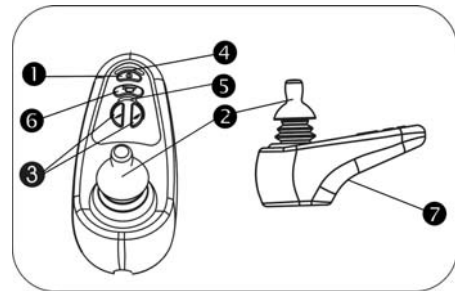

(Figure 5.1)

5.2 How to Operate Your wheelchair

5.2.1 Power ON/OFF

Press the power button. Be sure not to touch the joystick while turning on the controller. Your battery & diagnostics indicator should light up. **(See Figure 5.1)**

5.2.2 Speed Adjustment Buttons

The speed adjustment buttons allows you to set various forward and reverse speeds. The settings are a percentage of maximum power.

(See Figure 5.1) Notice the orange dots on the speed indicator. The more orange dots, the faster your speed.



CAUTION

- Please slow down before you get used to control your powered wheelchair.
- Please slow down your speed when driving indoors.

5.2.3 Driving Speed

You can choose between 1 to 5 orange dots in the speed indicator, with 5 being the maximum speed. Please refer to "Max. Speed" in Section 10. SPECIFICATIONS.

Speed Scale	Speed Equivalencies and Recommended Circumstances
1-2	Speed equivalent to walking slowly on foot On an decline Driving indoors or in a narrow space
3-4	Equivalent to walking at a normal speed Driving outdoors on flat ground
5	Speed equivalent to a brisk walk Driving in an open space On an incline

5.2.4 Forward, Reverse and Braking

Push forward on the joystick to make the wheelchair move forward.

Pull back on the joystick for the wheelchair to move backward. Release the joystick and the wheelchair will quickly slow down, the electromagnetic brake will be activated to stop the wheelchair.

Come to a complete stop before turning the power OFF. **(Figure 5.2)**

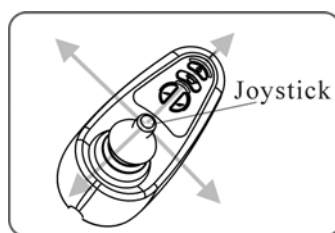

(Figure 5.2)



CAUTION

- The stopping distance will vary with your forward/reverse speed. Therefore, please gradually slow down and come to a complete stop well before any obstacles or danger.
- To park the wheelchair, be sure to park on flat ground and then turn the power to OFF.
- NEVER use the freewheel mode when going down an incline.
- The electromagnetic brake won't function in freewheel mode.

5.2.5 Horn Button

The horn will sound for the duration of time the button is pressed.

5.2.6 Battery Placement

Assure the lever of side mounting plate is released before you place the battery. Take the battery strap and put the battery into side mounting plate, then slide the battery to the end. Following the step as above to place the second battery, then connect the cable to controller module plug. Lock the lever of side mounting plate to finish the battery placement.

Note: The battery weight is 18 kg. Please carefully hold the battery during disassembly.

Controller position Adjustment

You can adjust your controller for convenience on control. Release the screw underneath the armrest with controller, adjust the proper position you demand and tighten the screw.

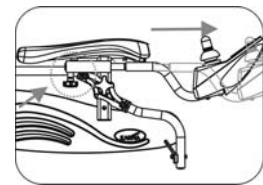

5.3 Shark Controller (Optional)

5.3.1. Power ON/OFF

5.3.2. Speed Adjustment Buttons

5.3.3. Horn Button

5.3.4. Joystick

5.3.5. Battery & Diagnostics Indicator

5.3.6. Speed Indicator

5.3.7. Charging Socket

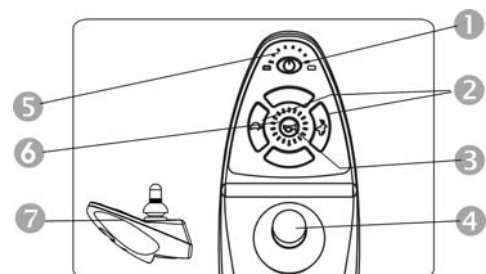

(Figure 5.3)

5.4. Power ON/OFF

Press the power button. Be sure not to touch the joystick while turning on the controller. Your battery & diagnostics indicator should light up. (See Figure 5.3)

5.5 Speed Adjustment Button

5.5.1 The speed adjustment button allows you to set various forward and reverse speeds.

5.5.2 The settings are a percentage of maximum power. (See Figure 5.3)

5.5.3 Notice the speed indicator. The more lights it shows, the faster you speed.



CAUTION

- Please slow down before you get used to control your powered wheelchair.
- Please slow down your speed when driving indoors.

5.6 Forward, Reverse and Braking

5.6.1 Push forward on the joystick to make the wheelchair move forward.

5.6.2 Pull back on the joystick for the wheelchair to move backward.

5.6.3 Release the joystick and the wheelchair will quickly slow down, the electromagnetic brake will be activated to stop the wheelchair.
(See Figure 5.4)

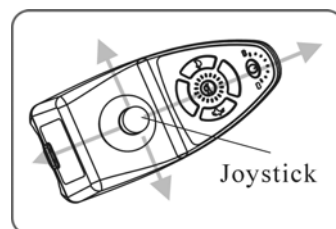

(Figure 5.4)

5.7 Driving Speed

The speed scale is printed on the speed dial label, ranging from 1 to 5, with 5 being the maximum speed. Please refer to "Max. Speed" in Section 10.SPECIFICATIONS.

Speed Scale	Speed Equivalencies and Recommended Circumstances
1-2	<ul style="list-style-type: none"> ⊙ Speed equivalent to walking slowly on foot ⊙ On an decline ⊙ Driving indoors or in a narrow space
3-4	<ul style="list-style-type: none"> ⊙ Equivalent to walking at a normal speed ⊙ Driving outdoors on flat ground
5	<ul style="list-style-type: none"> ⊙ Speed equivalent to a brisk walk ⊙ Driving in an open space ⊙ On an incline

5.8 To Stop

5.8.1 Release the joystick and the electromagnetic brake will stop the vehicle.

5.8.2 Come to a complete stop before turning the power OFF.

 CAUTION
<ul style="list-style-type: none"> ● The stopping distance will vary with your forward/reverse speed. Therefore, please gradually slow down and come to a complete stop well before any obstacles or danger. ● To park the wheelchair, be sure to park on flat ground and then turn the power to OFF. ● NEVER use the freewheel mode when going down an incline. ● The electromagnetic brake won't function in freewheel mode.

5.9 Horn Button

The horn will sound for the duration of time the button is pressed.

5.10 Battery Indicator

When the power is turned on, the battery indicator will light up with a possible total of three red, four orange and three green lines indicating the remaining power of the batteries. Both of the green light being lit indicates that the batteries are fully charged. If only the red lines are lit, this indicates that the batteries are (nearly out of

or) out of power.



SUGGESTION

- It is recommended that you charge the batteries immediately when the battery indicator shows only three or less red lines.
- After charging or replacing new batteries, drive the wheelchair for 2-3 minutes to make sure the batteries are fully charged before going on a long journey.
- In wintertime, the batteries may respond slowly and the drive range may also be reduced. You must store your wheelchair indoors above freezing temperatures.
- When driving on an incline, the battery indicator light might move up and down. This is normal.
- Even if the batteries are used properly their capacity will decay over time, thereby reducing the drive range (maximum distance traveled per full charge). Thus, when the drive range becomes about 50% of what brand new batteries would offer, it's time to replace them with new batteries. Otherwise, the batteries may die unexpectedly leaving you in a possibly precarious situation.
- The drive range will be shortened when driving frequently on slopes or uneven ground, as this consumes more battery power.

5.11 Unfolding the Chair

5.11.1 Step 1. With the chair in front of you and facing away, take hold of both handles and pull up into position, making sure that the spring lever becomes locked.

5.11.2 Step 2. Take hold of both armrest and pull them apart until the backrest is almost completely open (about 30 cm).

5.11.3 Step 3. Place hands on the top of the seat support rails with fingers pointing inwards and push down until the seat is completely open and the seat rails are fully located in the retaining cups.

5.12 Folding the Wheelchair

5.12.1 Step 1. Put fingers under the middle of the seat at both front

and rear, grasp and give a sharp pull upwards until the chair is nearly closed. Never grasp from the sides.

5.12.2 Step 2. Push the armrests together.

5.12.3 Step 3. Folding is completed by releasing the spring lever and folding back the backrest handles

5.13 Footrest Removal and Refitting

5.13.1 To remove footrest push / pull the release lever and rotate the footrest until it faces outwards.

5.13.2 To refit locate the footrest unit onto the frame lugs (at about 90 degrees to the side of the frame) and rotate it inward until the unit locks into place.

5.14 Armrest Flip-Back & Height Adjustment

5.14.1 You can flip your armrests back for convenience on movement.

Push the levers on the armrest release bases and flip the armrests back. When you put back the armrests, please make sure that the armrests are inserted into the armrest release bases correctly.

5.14.2 You also can adjust the height of the armrests for your comfort.

Release the armrest height adjustment knobs and adjust proper position you demand, and tighten the knob. Please align the knobs at the adjustment holes of the armrests. **(See Figure 5.5)**

5.15 Freewheel Levers

The KP-25.2 is equipped with freewheel levers to allow for manual pushing of the powered wheelchair if required.

5.16 To Select Neutral from the Engaged Position

Rotate the two levers located on the top of both motors, 90 degrees outward. The wheelchair will now roll freely. **(See Figure 5.6)**

5.17 To Engage the Motors from the Neutral Position

Simply rotate the levers 90 degrees inward toward the attendant.
(See Figure 5.7)



Figure 5.5

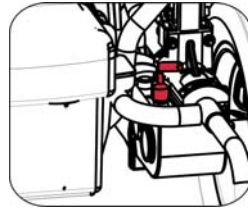

Figure 5.6

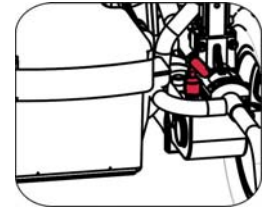

Figure 5.7

5.18 Armrest Flip Up and Height adjustment

KP-25.2 armrest is able to flip up for user to transfer. You may flip up the armrest by pressing the release lever located at the front base of the armrest. Assure the armrest is firmly locked into the position without movement after flip up. KP-25.2 is also able to adjust the armrest height by following steps. (See Figure 5-8) Pull the knob into horizontal position to release the armrest. (See Figure 5-9) Adjust the armrest to your desired position and retighten the knob by pushing down the knob into vertical position to fix the armrest. (See Figure 5-10) ◦



Figure 5-8



Figure 5-9



Figure 5-10



CAUTION

- Always ensure that the freewheel levers are engaged before turning on the controller.

5.19 Getting In And Out

Check control box is switched OFF when getting in and out.

5.20 Getting In

- 5.20.1 Step 1. Engage both parking brakes.
- 5.20.2 Step 2. Turn up the foot plates and swing footrest to the side.
- 5.20.3 Step 3. The user should now lower themselves into the seat using the armrests as supports.
- 5.20.4 Step 4. Turn the foot plates back down and re-locate the footrests so that the user can place their feet upon them.
- 5.20.5 Step 5. Release parking brake.

5.21 Getting Out

- 5.21.1 Step 1. Make sure that the chair is as close as possible to your transfer point.
- 5.21.2 Step 2. Back the chair sufficiently to ensure that the casters are pointing forward i.e. in line with the rear wheels and usually with the caster forks pointing forward. Ensure that where possible the rear of the chair is against a wall or, if not, it must be firmly held by an attendant.
- 5.21.3 Step 3. Engage both parking brakes.
- 5.21.4 Step 4. Turn up the foot plates and swing the footrests to the side.
- 5.21.5 Step 5. Slide forwards on the seat.
- 5.21.6 Step 6. Place one foot firmly on the ground with the knee at a right angle and the other foot slightly apart and further back.
- 5.21.7 Step 7. Place your hands on the front of the armrests and moving your weight forward, bring your head and shoulders up over your knees as you push yourself up.



CAUTION

- Never stand on the footplates when getting in to or out of the chair.
- Always ensure that the front casters are in line with the rear wheels and pointing forwards and that the back of the chair is secure either against a wall or firmly held by an attendant.

5.22 Motor Brakes

5.22.1 Electro-magnetic brakes operate automatically when the controller joystick is central with a delay of approximately 1/2 second. The controller automatically provides progressive deceleration before the electro-magnetic brakes come into operation.

5.22.2 To check the brakes are operating correctly: switch the wheelchair on and move the joystick in any direction. The brakes should disengage. Repeat this check in all four directions ensuring the brakes engage each time the joystick is released to its central position. An audible click from each motor indicates the brakes are working.

5.23 Parking Brakes - Hand Operated

5.23.1 The parking brakes operate directly on to the tyre providing positive locking of the drive wheels. They should only be used when the motors are disengaged. The brake levers are situated on the rear frame strut and can easily be operated by both user and attendant. Pull up for on & down for off. (ensure that the tyres are always inflated to the recommended pressure).

5.23.2 Care Points Avoid finger traps. Do not touch the rear wheels or casters.

5.23.3 Prevent children and others from putting their hands near the rear wheels or casters.

5.23.4 Never use the wheelchair with the wheels disengaged unless there is someone in attendance as the motor brake will not operate.

5.24 Install the Anti-Tippers

5.24.1 To Fit

Depress the rear button and insert it into the rear of frame.

The forward locating button must engage into the retaining hole in the frame.

5.24.2 To Detach

Depress the rear button and pull it out.



CAUTION

- Karma recommends that you should install anti-tippers in any occasion to prevent you tip over.

5.25 Transportation

5.25.1 The KP-25.2 Series fulfils the performance requirements for a "Crash Test" of ISO 7176-19 (Millbrook Report No. 01/0788) and is suitable to use as a seat in vehicles that have been adapted for this purpose. The wheelchair must be securely restrained as described in this manual. The The KP-25.2 Series was tested with a four point webbing system. For further information on the use of wheelchair restraints please refer to the manufacturer's user guide.

5.25.2 KARMA always recommend that the user transfers to the vehicle seating, because using a wheelchair as a seat in a vehicle does not provide the equivalent level of safety of a vehicle seating system.



WARNING

- Please transfer to a seat in the car if at all possible.



SUGGESTION

- Remember that the best solution is always to move the user from the wheelchair into a normal car seat, because using a wheelchair as a seat in a vehicle does not provide the equivalent level of safety of a vehicle seating system.

5.26 Before use



CAUTION

- If the back angle of the wheelchair is adjustable, do make sure that the wheelchair backrest should be positioned as close as possible to 90 degrees.

5.26.1 Please detach all easily removable accessories from the wheelchair and stow them in a safe place where they cannot move around and become a safety hazard.

5.26.2 A four point tie-down system should tightly fasten the lower wheelchair frame (hook mark) to the transport vehicle. The Tie Down Label (see the hook mark at the right) indicates the position of the fixing points for the tie down restraints on the

wheelchair .

5.26.3 An occupant restraint system using both a pelvis and harness must also be fastened to the transport vehicle to insure user safety. Again, please refer to the restraint system's instructions.

5.26.4 The attendant / transporter must double-check all fastening points for proper connection and tightness to assure the wheelchair users safety. The attendant / transporter must be fully cognisant of the fastening system's usage and its weight limitations.

5.26.5 See <http://www.unwin-safety.com/> for more information.

5.26.6 Method of Restraint

The KP-25.2 Series was tested with four point webbing systems. Please refer to the restraint manufacturer's user guide for further details of its operation

5.26.6.1 Fitting the Front Restraint

5.26.6.1.1 Connect the straps around the wheelchair frame and caster bracket . The anchor point is marked with a yellow sticker (Tie Down Label).

5.26.6.1.2 Release the brakes and reverse the wheelchair to tension the front straps. Apply the wheelchair brakes (the brakes should be left on during transport).

5.26.6.2 Fitting the Rear Restraint

5.26.6.2.1 Attach the rear straps into rail approximately 300 mm behind the wheelchair backrest.

5.26.6.2.2 Attach the hooks to the rear frame of the wheelchair. Tension the restraint until the wheelchair is secure.

5.26.6.3 Fitting Seat Belt

5.26.6.3.1 Fasten the three point safety belt around the user.

5.26.6.3.2 The occupied wheelchair should be located in a forward-facing configuration, with the parking brake applied.

5.26.6.3.3 Pelvic restraints should make full contact across the front of the body near the junction of the thigh and pelvis as pictured below (correct seat belt position).

5.26.6.3.4 Restraints should not be held away from body by wheelchair components such as armrest or wheels as pictured below (Incorrect seat belt position).

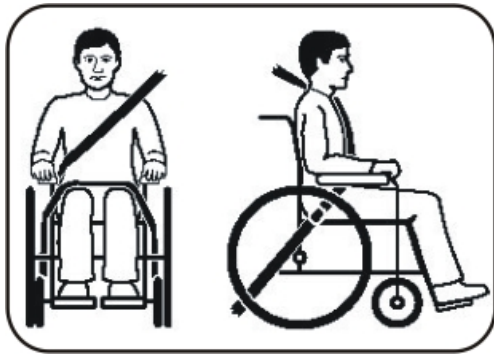

Correct seat belt position



Incorrect seat belt position



CAUTION

- When transporting or lifting, never hold on to attachments or accessories (front/rear wheels, handrims, castors, footrests, armrests, anti-tippers etc.)
- All lifting should be done with a straight back. Straight legs to lift the chair. Carefully carry it up or down steps; be aware of how you place your feet, do not cross them and trip yourself up.

5.27 Adjusting the length of the pelvic belt

5.27.1 Identify the require length of the belt. (Figure 5-11)

5.27.2 Push the two part of belt through buckle to make the belt longer or shorter. (Figure 5-12)

5.27.3 Pull the two parts of belt tight. (Figure 5-13)

5.27.4 Push buckle up to the plastic clip so that the belt can not slip out of position. Please check that there is no gap between the clip and buckle. (Figure 5-14)



SUGGESTION

- We recommend that the belt is fitted quite tightly around the pelvis. Please tighten until you can just get your fingers between user and seat belt. Please check that the belt is fastened correctly as recommended. If this is not possible please consult your supplier.



Figure 5-11



Figure 5-12



Figure 5-13



Figure 5-14

5.28 How to Operate It

5.28.1 When you sit on the wheelchair, fasten the pelvic belt.

5.28.2 Adjust the belt and make it fit your body for comfort and security.

5.28.3 When you don't use it, please fasten the belt to prevent the belt from dropping into rear wheels during motion.

5.29 Maintenance

5.29.1 The pelvic belt is made from 100% polyester fibre and the clasp is made from plastic. It does not require any maintenance but should be inspected every month to ensure that the edges are not frayed and weekly to make sure that it correctly fits the user.

5.29.2 If there are any signs of deterioration, please replace it immediately.

6. BATTERIES AND CHARGER

6.1 Charging the Batteries

Before you attempt charging, ensure you read and understand the instruction manual supplied with the battery charger, and you choose the correct input voltage for battery charger.

6.2 Charge Your Batteries If Any of the Following Conditions Occur

6.2.1 If you have used your wheelchair for more than an hour continuously.

6.2.2 You've used more than one third of the total charge.

6.2.3 When you haven't used the wheelchair for more than two weeks.

6.2.4 If the current charge is not enough to reach your final destination.

6.3 Be Sure To Follow the Procedures Listed Below Precisely

6.3.1 Turn the wheelchair OFF.

6.3.2 Connect the charger's cord to a power outlet.

6.3.3 Locate the charging socket at the front of the joystick housing.

Then connect the charger's round plug to the charging socket.

(See Figures 6.1 and 6.2)

6.3.4 The charger's orange LED will light up as soon as the charging starts. The charging time is at least 6 hours, but it could be as long as 10 hours, depending on the status of the batteries and temperature.

6.3.5 The orange LED will change to green when the charging is completed.

6.3.6 Disconnect the cord and pull out the round plug from the charging socket.

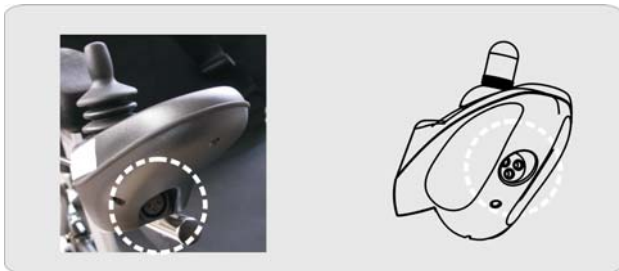

(Figure 6.1)



(Figure 6.2)



SUGGESTION

- Do not disconnect the charger cord if the charging is not completed. The battery life will be seriously shortened or decayed if the batteries are repeatedly used without being fully charged. Therefore, be sure to always charge the batteries fully.
- Always complete the charging by letting the charge LED light turn green. NEVER stop charging before it is complete.
- When finished charging, disconnect the charger plug from the charging socket as soon as possible. Even when the charger is turned OFF, the electric power will slowly discharge if the cord is not disconnected. DO NOT leave the charger ON connected to the wheelchair for more than 24 hours.
- Charging time depends on the surrounding temperature; it takes longer in the winter.



CAUTION

- Please follow the guidelines below to avoid accidents while charging.
- Be sure to only use a KARMA approved battery charger and charge the battery completely every time. The battery can be damaged if a non-genuine charger is used.
- Never disassemble or modify the charger. This will negate the warranty.
- Please charge in a well-ventilated area where the battery is not directly exposed to sunlight. Do not charge the battery under rainfall, in morning dew or in an area where the humidity is high.
- Do not cover the wheelchair with any waterproof cloth or other objects while charging. Don't charge in temperatures less than -10°C (14°F) or higher than 50°C (122°F) as the charger may not work well and the battery may become damaged.
- The charger is not guaranteed to be water resistant.
- Valve Regulated Lead-Acid batteries do not have a memory function like cell phone batteries have. Please get in the habit of recharging your VRLA batteries frequently.



WARNING

- Keep your wheelchair away from flammable objects while charging, as it may lead to fire or explosion of the battery.
- Since the battery may produce hydrogen, do not smoke while charging and charge in a well-ventilated area.
- Never connect or disconnect the plug (cord) with wet hands or if the plug (cord) is wet to avoid possible electric shock.
- Never attempt to recharge the batteries by attaching cables directly to the battery terminals or clamps. **DO NOT** jump start your wheelchair!
- **DO NOT** attempt to recharge the batteries while the powered wheelchair is in operation.



CAUTION

- New batteries **MUST** be fully charged prior to initial use of the powered wheelchair.
- Always charge new batteries before initial use or battery life will be reduced.
- As a general rule, recharge batteries as frequently as possible to assure the longest possible life and to minimize required charging time. Plan to recharge them when use of the powered wheelchair is not anticipated.

6.4 Charger

The battery charger supplied by Karma is for indoor use only, it must be protected from moisture and external heat source.



CAUTION

- Before charging, make sure to set the 115V ↔ 230V switch to match the local AC voltage. If the switch is improperly set to a lower or higher voltage position, it will cause damage to the charger, and, Change the 115V ↔ 230V switch settings only when charger is disconnected from AC line voltage.



WARNING

- The fan inside the charger will start to work when you turn on the charger. (for 8A charger will start to work as temperature is over 50°C and stop running under 50°C) If you find that the fan does not function properly, **DO NOT** use the charger. Otherwise, the charger may overheat and start a fire.

6.5 Batteries

6.5.1 Do not expose the batteries to temperatures below -10°C (14°F) or above 50°C (122°F) when charging or storing the vehicle.

6.5.2 Exceeding the specified temperature range can lead to either freezing or overheating of the batteries. This will damage the batteries and shorten their lives

6.5.3 The batteries used on your wheelchair are maintenance free sealed lead acid batteries. Thus, it is not necessary to change or refill the battery liquid.



WARNING

- Do not open the battery seal cap at any time.
- After ANY adjustments, repair or service and BEFORE use, make sure that all hardware is tightened securely. Otherwise, injury or damage may occur.
- When removing/installing batteries, keep all foreign objects, especially metal, away from battery terminals.



CAUTION

- Place the powered wheelchair in a well-ventilated area where work can be performed without risking damage to carpeting or floor covering.
- Failure to use the correct battery size and/or voltage may cause damage to the powered wheelchair and give unsatisfactory performance. For replacement of batteries, please contact your local KARMA supplier/dealer in order to ensure that the new batteries are correctly be used.



WARNING

- There are many risks involved with improper disposal of batteries, whether damaged or not.
- Batteries may contain heavy metals and be considered hazardous waste.
- Many regions around the world now strictly enforce laws to help protect our environment. By not disposing of batteries properly, you may be liable for fines from your local through national government.
- By not recycling batteries, they end up in landfills that are already low on

space. From these land fills, lead and other chemicals may leach into streams and rivers destroying ecosystems and poisoning local water resources.

- Improper disposal of batteries may also cause injury to unsuspecting others that come in contact with them. If you come in contact with fluids or corroded powder from a battery, rinse with water and contact a physician if necessary. If contact with eyes occurs, rinse for 15 minutes and then visit a physician.
- Incinerating or burning a battery will cause it to explode! Please see the end of Section 11. Cleaning & Recycling for more information.
- Do not use an extension cord when charging your batteries. A risk of fire and /or electric shock could be encountered.

6.6 Cleaning the Batteries

If a battery is contaminated by dirty water, battery acid, dust or other soil, the battery will discharge quickly. Therefore, please follow the following steps to clean the battery:

6.6.1 Turn the power OFF ;

6.6.2 Use a clean cloth to wipe off the soiled part of the wheelchair around the battery.

6.6.3 Clean the terminals and inside of the battery clamps by using a battery cleaning tool, wire brush or medium grade sandpaper. Upon completion, these areas should be shiny, not dull.

6.6.4 Examine the battery clamps/terminals for corrosion, if the terminal is covered by white powder, please stop using the battery due to it indicates that there's possible leakage of the battery. Please replace the batteries.

6.6.5 Carefully dust off all metal particles.

7. INSPECTION AND MAINTENANCE

7.1 Daily Check

Check the following items before driving. If you find anything abnormal, visit your KARMA wheelchair dealer for further inspection before using it.

Item	Inspection Content
Joystick Controller	Is the joystick loose and/or making noise? Can the joystick be turned left and right smoothly? Can the speed buttons be adjusted freely and do they function well? Does the wheelchair stop when the joystick is released completely? Does it light up when the power is ON? Is there enough power for your trip? Does the horn work well?
Motor	Is there any abnormal noise? Does the electromagnetic brake work properly?
Freewheel Mode	Do the freewheel levers work properly?
Driver's Seat	Does the driver's seat recline? Do the seat angle adjustment knobs(or buttons)work properly? Does the surface of the seat remain or break?
Tires	Are there any cracks or other damage to the tires? Check the tire tread depth and air pressure.
Other	Is there any abnormal motor noise?



CAUTION

- Visit a KARMA wheelchair dealer for inspection and maintenance if you find anything abnormal.

7.2 Regular Maintenance Record

To make sure your wheelchair is in good condition, visit your KARMA wheelchair dealer regularly for maintenance (and keep records accordingly) every six months after purchasing. A maintenance/service fee may apply.



SUGGESTION

- Even if you don't use the wheelchair for a long time, the wheelchair should still be maintained regularly.
- You should clean your wheelchair, inside and out, regularly to keep it beautiful and safe.

I - Inspection

A - Adjustment

△ - Repair

3 - Replacement

T - Tightening

L - Add Oil

Item/Period		1 mth	6 mth	12 mth	18 mth	24 mth	30 mth
Joystick Control Unit			I	I	I	I/3	I/3
Power Module			I	I	I	I/3	I/3
Controller Buttons			I	I	I	I/3	I/3
Connection to the Electrical System				I		I	I/A
Motor	Operation and Noise		I	I	I/A	I/A	I/3
	Electromagnetic Brakes		I	I	I	I/3	I/3
	Connection to the Electrical System			I		I	
Batteries	Loose or Corroded Terminals			I		I	
	Connection to the Electrical System			I		I	
	Damage to the Electrical Cord/Cable			I		I	
Charger	Charging Function and LED Light	I	I	I	I/△	I/△	I/△
	Socket, Plug and Cords			I		I	

Item/Period		1 mth	6 mth	12 mth	18 mth	24 mth	30 mth
	Fan Functions Properly (if applicable)			I		I/△	
Driver's Seat	Recline Function			I/L		I/L	
Tires	Cracks/Surface Damage	I/3	I/3	I/3	I/3	I/3	I/3
	Tread Depth		I	I/3	I	I/3	I
	Abnormal Wear Pattern			I/3		I/3	
Wheel	Tightness of Bolts and Nuts			T		T	
Rim	Wear or Deformation Around Tires			I/3		I/3	

7.3 Tires

7.3.1 The condition of the tires is affected by the way you drive and use your wheelchair.

7.3.2 Inspecting Tire Tread: please check the tread depth regularly. Replace the tires when the tread depth is less than 0.5 mm.



CAUTION

● Please ensure that the tire is flat before you disassemble the rim to replace the pneumatic tire.

7.4 General Maintenance

7.4.1 You must maintain the vehicle more frequently if you drive on grass, sand or gravel roads often.

7.4.2 Do not use water, oil or other chemical solutions to clean your wheelchair. Be sure NOT to spray the vehicle with water, as not to damage the electronic components and PCB circuit board.

7.4.3 Please clean the vehicle by wiping it with either a dry or moist cloth.

7.4.4 Please take the vehicle to an authorized KARMA wheelchair dealer

for repairs and adjustments. Improper adjustments could lead to wheelchair malfunction or an accident.

7.4.5 Please use a soft and dry cloth to keep your wheelchair clean.

Use moderate or mild detergent to clean the wheelchair, if necessary.



CAUTION

- Before performing any maintenance, be sure to turn the power OFF and unplug the charger if connected.
- DO NOT over-tighten hardware. This could cause damage to the frame and hardware.



SUGGESTION

- Do not directly spray water on your wheelchair to wash it, as this could lead to a malfunction in the electric system.
- Do not use gasoline, solvents or other abrasive solutions; the casing may become deformed or damaged.



WARNING

- After ANY adjustments, repair or service and BEFORE use, make sure that all hardware is tightened securely, otherwise injury or damage may occur.

7.5 Suggested Maintenance Procedures

7.5.1 Before using the powered wheelchair, make sure all nuts and bolts are tight.

7.5.2 Check all parts for damage or wear and have a qualified technician replace it if necessary.

7.5.3 Check all parts for proper adjustment.

7.5.4 Ensure that the batteries are properly maintained and charged as required.

7.5.5 Inspect brake for proper operation.

7.5.6 The wheels and tires should be checked periodically for cracks and wear, and should be replaced by a qualified technician.

7.5.7 Regularly check for loose nuts and/or bolts in the front and rear wheels. If loose, have them adjusted by a qualified technician.

7.5.8 Clean dirt, dust and grease from exposed components.

7.5.9 A qualified technician can be found with an authorized distributor/dealer.

7.6 Transporting and Storing

7.6.1 The wheelchair may be disassembled for ease of transport.

Please refer to section 5 for more detailed information on the individual steps. Reverse the order for reassembly.

7.6.2 Please store the wheelchair in a location where it is out of direct sunlight, rain and dew.

7.6.3 When stored for a long time, please charge the batteries to full and then disconnect the battery terminals.

7.6.4 For more details, consult your KARMA wheelchair dealer.

8. OPTIONAL ACCESSORIES

8.1 Cushion

Reduces pressure, lowers temperature, fits any shape and prevents bedsores.

Suitable for: all wheelchair users, stroke patients, spinal cord injuries, office use and driving.



8.2 Curb Climber

Assist your chair to overcome 8 cm high obstacles

8.3 How to Install The Curb Climber

8.3.1 Insert the slot A to the screw. (See Figures 8.1, 8.2)

8.3.2 Press the lever B and put the slot C into the screw. (See Figures 8.3)

8.3.3 Finish installation. (See Figures 8.4)

8.4 How to Remove The Curb Climber

8.4.1 Press the lever B and remove the slot C from the screw.

8.4.2 Remove the slot A from the screw.

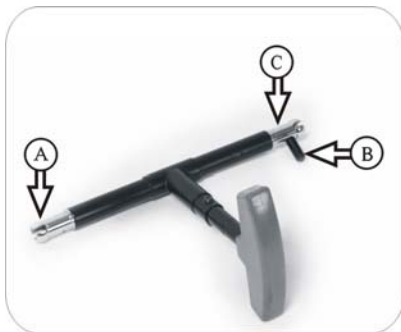

(Figure 8-1)

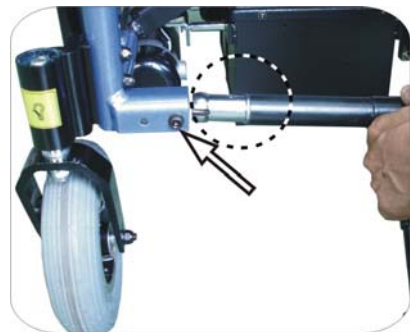

(Figure 8-2)

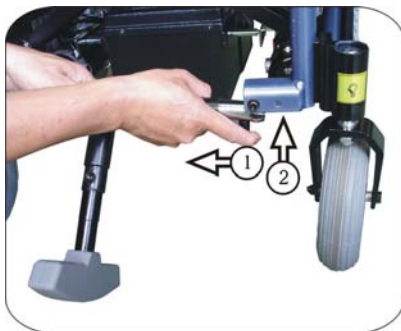

(Figure 8-3)



(Figure 8-4)

9. TROUBLESHOOTING

Trouble or Problems with Your Wheelchair





You can inspect the following before taking your wheelchair to a KARMA wheelchair dealer.







Problem	Checking Points and Corrective Action
My wheelchair does not start	Is the power turned OFF? Turn ON the power.
	Do the batteries still have power? Is the battery indicator light not on? Charge the batteries.
	Is the charger plugged into the wheelchair? Unplug the charger and put it away.

If you cannot solve the problem by yourself, contact your KARMA wheelchair dealer for help.

9.1 VRII Controller, Battery & Diagnostics Indicator

The following table indicates what the gauge will display for any given state.

Indication	Status	Meaning	What to do
	1 signal	The battery needs charging or there is a bad connection to the battery.	Check the connections to the battery. If the connections are good, try charging the battery.
	2 signals	The left hand motor has a bad connection.	Check the connections to the left hand motor.
	3 signals	The left hand motor has a short circuit to a battery connection.	Connect your service agent.
	4 signals	The right hand motor has a bad connection.	Check the connections to the left hand motor.

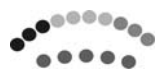
Indication	Status	Meaning	What to do
	5 signals	The left hand motor has a short circuit to a battery connection.	Connect your service agent.
	6 signals	The wheelchair is being prevented from driving by an external signal.	Please remove the charger.
	7 signals	A joystick fault is indicated.	Make sure that the joystick is in the center position.
	8 signals	A joystick fault is indicated.	Make sure that all connections are secure.
	9 signals	The parking brakes have a bad connection.	Check the parking brake and motor connections and make sure all connections are secure.
	10 signals	An excessive voltage has been applied to the control system.	Check the battery connections.
	10 signals + Speed indicator	A communication fault is indicated.	Make sure that the joystick cable is securely connected and not damaged.

Shark Controller (Optional), Battery & Diagnostics Indicator









The Battery Gauge is used to indicate power on and provides an estimate of the remaining battery capacity.

Every green LEDs lit indicate well charged batteries.

If only **amber and red** LEDs are lit, the batteries are moderately charged. Recharge before undertaking a long trip.

If **only red** LEDs are lit, the batteries are running out of charge. Recharge as soon as possible.

The following table indicates what the gauge will display for any given state.

Display	Description	This means...	Notes
	ALL LEDs Off	Power is Off	
	ALL LEDs ON steady	Power is ON	Less LEDs imply a reduced battery charge.
	Left RED LED is flashing	Battery charge is low	The batteries should be charged as soon as possible.
	Right to left 'chase'	SHARK is being brought out of Lock mode	To unlock SHARK, Press the Horn button twice within 10 seconds.
	Left to right 'chase' alternating with steady display	SHARK is in programming, inhibit and/or charging mode	The steady LEDs indicate the current state of battery charge..
	ALL LEDs flashing slowly	SHARK has detected an Out Of Neutral At Power Up (OONAPU) condition	Release the joystick back to neutral.

Flash Codes



Flash codes indicate the nature of an abnormal condition directly from the SHARK Information Gauge. Without the use of any servicing tools, the condition can be simply diagnosed.

Number of Flashes	Description	
1	User Fault	Possible stall timeout or user error. Release the joystick to neutral and try again.
2	Battery Fault	Check the batteries and cabling. Try charging the batteries. Batteries may require replacing.
3	Left Motor Fault	Check the left motor, connections and cabling.
4	Right Motor Fault	Check the right motor, connections and cabling.
5	Left Park Brake Fault	Check the left park brake, connections and cabling.
6	Right Park Brake Fault	Check the right park brake, connections and cabling.
7	SHARK Control Unit Fault	Check the SHARK Communications Bus connections and wiring. Replace the Control Unit.
8	SHARK Power Module Fault	Check SHARK connections and wiring. Replace the Power Module.
9	SHARK Communications Fault	Check Battery voltage is greater than 17V. Check SHARK Bus Cable. Replace the SHARK Power Module. Replace the SHARK Control Unit.
10	Unknown Fault	Check all connections and wiring. Consult a service agent.
11	Incompatible Control Unit	The Control Unit is incompatible with the Power Module. Ensure the brand of the Power Module matches that of the Control Unit.

10. SPECIFICATIONS

(±1 cm±1 kg)

Model	KP-25.2	
Description		
Seat Width	42 cm	47 cm
Front Seat Height	50 cm	
Seat Angle	4°	
Legrest Length	39 cm ~ 51 cm	
Motor(Nominal Output/Max. Output)	200W/420W	
Batteries	50Ah*2	
Controller	VR2	
Caster (Front)Wheel	20 cm*5 cm	
Rear Wheel(inch)	12"	
Max Safe Slope	10°	
Max. Speed	6 km/hr	
Range (km)	38 km	
Maximum Obstacle Climbing Ability	5 cm	
Min. Turning Radius	82 cm	83 cm
Overall Length (with & without legrest)*	110 cm	110 cm
Width* Height	*59 cm *96 cm	*64 cm *96 cm
Max. User Weight	135kg/115kg(w/solid wheel)	
Weight with Accessories	33 kg	
Weight without Batteries	35 kg	
Total Weight (with Batteries)	70 kg	

* Range (the maximum driving distance per complete charge) is estimated based on the following conditions: 20°C (68°F), an 80 kg (176 lb) driver, brand new fully charged batteries and a constant driving speed of 6km/hr.

The KP-25.2in Australia was tested for 125kg conforms to AS/NZS

10.1 KP-25.2 Series Static Stability Test Result

-The degree tolerance is +0, -1 degree.

-The test condition: size of test dummy used: 115 kg

Test Requirement	Min.	Max.
Static Stability Uphill	16°	24°
Static Stability Downhill	31°	35°
Static Stability Sideway	22°	23°

11. CLEANING & RECYCLING

11.1 Cleaning

11.1.1 In order to lengthen the life of your wheelchair, it is suggested that you clean the wheelchair periodically (if not daily), especially after it is used in the rain or snow.

11.1.2 We suggest that you don't use your wheelchair in the rain or snow.

11.1.3 If you are traveling and get caught in the rain, we suggest you try to find shelter and turn OFF your wheelchair while waiting it out.

11.1.4 If you can't find shelter, proceed to your destination.

11.1.5 However we do not recommend you do this often as it may shorten the life of your wheelchair or cause damage.

11.1.6 Driver's seat upholstery: use soapy water. Wring out the sponge/cloth before scrubbing. Do not use the wheelchair until it is dry.

11.1.7 Frame: wipe with a damp cloth, but be sure not to splash/spray the wheelchair with water, as doing so may damage the motor, electrical wiring and battery.

11.1.8 If compressed air is available, you can use the compressed air to clean your wheelchair (do not exceed 7K and keep the nozzle at least 10 cm away from your wheelchair).

11.1.9 Casing: wipe with a damp cloth. After it is dry, coat the casing with a light layer of wax, if desired.

11.2 Post-Consumer Recycling

11.2.1 A post-consumer recycling plan should follow the Environmental Protection Administration's regulations.

11.2.2 The items listed below are for reference only as local law and regulation may vary.

Material	Part Name	Method
Aluminum-alloy	Frame	Recyclable
ABS	Various	Recyclable
Various	Battery	Recyclable
Various	Motor/Reduction Gear	Recyclable
Various	Electric Parts	Recyclable

11.2.3 There are many organizations in many countries you can find on the internet that will accept used goods for charity or disassemble electronic equipment and batteries to recycle them.

11.2.4 Please search the information highway to help less fortunate individuals and protect our planet for future generations.

11.2.5 If you do not have access to the world wide web please use your local phone directory, ask for operator assistance or go to your local government center for more information.

11.2.6 Various parts of this wheelchair should be recycled to the collection and recycling location nearest to you. Earth Day is every day.

Check with your local recycling center on where and how to recycle used batteries as this information varies from region to region.



12. WARRANTY

12.1 Serial Number

To ensure after-sale service and warranty, please record and fill in the vehicle identification number. The serial number can be found on the steering column below the control panel.

Model	KP-25.2
Serial Number	

12.2 Contents of Warranty

12.2.1 Repair will be provided free of charge if the problems are due to manufacturing or defective components within the warranty period (a repair of this kind will hereafter be called warranty repair).

12.2.2 The warranty repair can be performed by authorized KARMA wheelchair dealers only.

12.2.3 KARMA is not responsible for the transportation costs for repair and replacement.

12.2.4 Replaced parts will be the property of KARMA.

12.3 Warranty Duration and Parts Covered by the Warranty

Please contact your local dealer.

12.4 Items Not Covered

The items listed below are not covered:

12.4.1 Consumable parts such as brake shoes or pads, clutch shoe and lining, light bulbs, fuses, upholstery and seating, brake cable, oil seal packing and gasket, screws/bolts and washers, lubricant oil and grease, carbon brush inside the motor, battery liquid, footrest carpet, et cetera;

-
- 12.4.2 Those that do not affect the quality and functioning of the wheelchair such as noise or vibration;
 - 12.4.3 Wear and tear resulting from usage as well as conditions resulting from lapse of time (e.g., normal aging and deterioration of paint, electroplating, plastic parts, etc);
 - 12.4.4 Damage due to a lack of maintenance or improper operation and storage;
 - 12.4.5 Fees for routine inspections, adjustments, adding oil, cleaning and other maintenance;
 - 12.4.6 Fees for regular inspections and maintenance; and
 - 12.4.7 Any fees incurred as a result of warranty repair, loss or compensation because of the unavailability of the wheelchair (telephone use, shipping, car rental, travel costs, et cetera).

12.5 Problems Not Covered

Problems caused by the following reasons are not covered:

- 12.5.1 Failure to carry out the regular inspection and maintenance recommended by this owner's manual;
- 12.5.2 Improper storage;
- 12.5.3 Tampering by changing or adding components to the vehicle, which are not approved by KARMA;
- 12.5.4 Damage caused by using non-KARMA genuine parts or other parts not recommended by KARMA;
- 12.5.5 Abuse or misuse of the vehicle such as driving over curbs and overloading the wheelchair with passengers or goods;
- 12.5.6 Driving in places where the vehicle should not normally be driven or used;
- 12.5.7 Damage or surface corrosion from environmental factors such as airborne fallout (chemicals, tree sap, et cetera), stones, hail, windstorms, lightning, floods and so on;

12.5.8 Change of any material or component parts not authorized by KARMA (Don't carry objects that may lead to the wheelchair being unbalanced) ;

12.5.9 The wheelchair shall not be pulled or pushed by another vehicle when there is a person on the wheelchair or the rear wheels are not set to the freewheel mode; and having its structure inspected.

12.5.10 Do not drive a wheelchair that is older than 10 years without

12.6 The Responsibilities of the User

The following items are the responsibility of the user:

12.6.1 Proper use of the vehicle in accordance with this Owner's Manual;

12.6.2 Performance of the daily inspections;

12.6.3 Performance of the regular maintenance recommended by KARMA; and

12.6.4 Keep a record of vehicle inspection and maintenance in the back of this Owner's Manual.

12.7 Warranty Effectiveness

The warranty form must be completely filled out and stamped by the KARMA dealership where the wheelchair was purchased.

12.8 Transfer of Warranty Rights

If you purchase a second-hand KARMA wheelchair while it is still with in the warranty period, bring the Owner's Manual and the vehicle to the dealership where the wheelchair was purchased for registration.

Warranty Form (You may photocopy this from)

Full Name:	
Gender:	Male <input type="checkbox"/> Female <input type="checkbox"/>
Date of Birth:	Year Month Day
Address:	
Model:	KARMA KP-25.2
Serial Number:	
Date of Purchase:	Year Month Day
Purchaser Signature:	

Dealer's Data

Name of the Store:	
Phone No. and Address:	

If you have any suggestions on how to improve our products, please don't hesitate contacting your local dealer to let us know what you think of your wheelchair. Thank you and enjoy.

karma

National agent:

Sold and serviced by:

KARMA MEDICAL PRODUCTS CO., LTD.

[Http://www.KarmaMedical.com](http://www.KarmaMedical.com)

E-mail:globalsales@karma.com.tw

KARMA reserves the right to modify information herein without further notice.

Karma reserves the right to modify information herein without further notice.

110404050011 104-45017

Rev.14 2018.07