



Splashy Big

User Manual



Family Freedom



Please read all user instructions carefully before using Splashy BIG. These instructions can also be downloaded from our website **www.fireflyfriends.com** along with videos, diagrams and other useful downloads.

Contents

01 Intended Use	p.05
02 Declaration of Conformity	p.06
03 Terms of Warranty	p.06
04 Safety Information	p.07
05 Cleaning and Care Information	p.08
06 Product Inspection and Servicing	p.10
07 Important Guidelines	p.11
08 Re-issuing Firefly Products	p.11
09 Instructions for Use	p.12
10 Sizing Information	p.31

SECTION 01: Intended Use

The Splashy BIG bath seat is intended to provide support for children with disabilities who require head and trunk support whilst using the bath.

For structure, safety and support, it is essential that Splashy BIG is attached to the floorsitter base unit at all times.

Splashy BIG is designed for children aged between approximately 7–14 years old and with a maximum user weight of 55kg (121lbs).

The back rest, seat base and floorsitter base unit should fit easily and securely together – see Section 09 of this manual for further instructions.



Children should not be left unattended/unsupervised in their Splashy BIG bath seat at any time, as they could be at risk of drowning or injuring themselves.

We recommend that an adult completes product inspections in accordance with Section 06 of this user manual to ensure the product is safe to use. Firefly Friends Ltd. and James Leckey Design Ltd. cannot accept any responsibility if the product is used outside of its intended use. If in doubt please contact Firefly customer services on UK 0800 318265 or ROI 1800 626020.

Daily activities tested and approved by Firefly Friends Ltd and James Leckey Design Ltd are:

1. In the bath or shower
2. For water play activities

Use of Splashy BIG outside the bathroom, (such as the garden or beach) should be assessed in advance. Be mindful that Splashy BIG contains working floorsitter-to-seat connections which could be affected by small particles and/or obstructions (such as soil, grass or sand). If Splashy BIG does come into contact with any substances that could affect the floorsitter-to-seat connections, ensure they are thoroughly rinsed after use. Please refer to Section 04 for Safety Information and Section 05 for further guidance on cleaning and care.

SECTION 02: Declaration of Conformity

James Leckey Design Ltd., as manufacturer with sole responsibility for the Firefly brand, declares that Splashy BIG conforms to the requirements of the medical device directive 93/42/EEC. Splashy BIG has been CE marked as a Class 1 medical device.

SECTION 03: Terms of Warranty

The warranty for Splashy BIG applies only when the product is used according to its intended use, following all manufacturer's specifications. A one year warranty is provided with this James Leckey Design Ltd. manufactured product.

Goods can be returned to us for warranty, repair or replacement up to 12 months from receipt. Once you contact us, we will arrange collection of the goods at our expense and, once returned to us we will repair or replace goods and return them to you within 14 days. In all cases, it is the customers' responsibility to ensure the goods being returned are suitably packaged, preferably in the original packaging.

SECTION 04: Safety Information

1. Always read user instructions fully before use.
2. Children should not be left unattended/unsupervised at any time in this product.
3. If using Splashy BIG at the beach, never leave your child unattended near the sea.
4. Check that all of the Splashy BIG components are securely assembled according to user instructions before use. Splashy BIG must be attached to the floorsitter base unit at all times and placed on a firm, solid, static surface. Never use Splashy BIG on a sloping surface.
5. The maximum user weight for Splashy BIG is 55kg (121lbs). **This should never be exceeded.**



Failure to follow these instructions may put you or the child at risk.

6. Splashy BIG contains parts which could present a choking hazard to small children. Check all components are tight and securely fastened before use – including toggles and straps.
7. **Do not** modify Splashy BIG or use components other than Firefly approved components with Splashy BIG at any time. This may put your child at risk and may also invalidate your warranty.
8. When using Splashy BIG in environments which may have soil/sand/grass or small components, always ensure that you clean out the floorsitter-to-seat connections after every use to prevent any obstructions. For reconnecting floorsitter to seat please refer to Section 09.2.7
9. After use, allow Splashy BIG to dry thoroughly before storing it away carefully. Splashy BIG should be kept away from all direct sources of heat including naked flames, cigarettes, electric and gas heaters.
10. Clean the product regularly in accordance with Section 05 of this user manual.
11. Complete maintenance checks on a **regular** basis to ensure your product is in good working condition. Splashy BIG should not be used if any of the parts are faulty.
12. If you are in **any doubt** about the safe use of Splashy BIG or the floorsitter base unit, or if any parts should fail, please cease using the product immediately and contact Firefly customer services on UK 0800 318265 or ROI 1800 626020.
13. Any promotional items supplied with Splashy BIG should not be used unsupervised.
14. When using the stabiliser ensure stabiliser is fully locked.
15. It is not possible for us to provide specialised moving and handling advice as the circumstances will differ for each family. For guidance on moving and handling, speak with your therapist.

Improper moving and handling can cause risk of injury to you and your child.

We recommend you consult with your therapist for moving and handling advice prior to use.

SECTION 05: Cleaning and Care Information

How to Maintain

- When cleaning Splashy BIG we recommend that you use only warm water and a non-abrasive detergent. Never use organic solvents or dry cleaning fluids.
- Do not machine wash or steam clean Splashy BIG's foam components as it may cause the foam to lose shape and warp.
- We recommend that you do not use any type of prescribed medicated lotions in the bath water during the bathing process as this may contribute to the breakdown of Splashy BIG's materials.
- Wipe the bath surface clean of any residue or dirt before attaching the floorsitter to it, ensuring the rubber feet grip firmly to the bath.
- To remove sand/soil/grass or any small particles that may be in the floorsitter-to-seat connections, slight tapping of the area will encourage the particles to fall out. Rinse thoroughly to ensure there is no build up of particles inside the connections. For stubborn blockages on the floorsitter, the latch can be given a thumb push to remove any particules and aid release.
- Should your bath seat come into contact with salt water, rinse all parts thoroughly with fresh, clean water.

5-point Harness

The Splashy BIG 5-point harness can be removed and cleaned with soapy water.

Floorsitter Base Unit

1. Ensure the bottom of the floorsitter base unit and stabiliser are cleaned after every use to ensure grip on the bottom of bath.
 2. Soap and water can be used for daily cleaning.
 3. Do not use solvents to clean the floorsitter base unit.
-

Splashy BIG Foam Seat Base, Backrest and Supports

1. Soap and water can be used for daily cleaning.
2. The EVA foam covers can be removed and washed periodically to avoid a build-up of residue and grime.

Splashy BIG's EVA foam covers can be removed and washed every few months.

1. The EVA covers are attached by eight hooks. Two on the seat back and six on the seat base.
2. Detach all hooks by hand (do not use tools).
3. Wash using soapy water.
4. Ensure the covers are completely dry before reattaching.
5. Ensure all hooks are engaged when putting the covers back on.

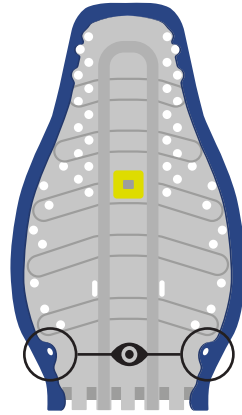

Hook locations

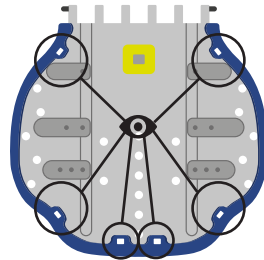

! If Splashy BIG is being used in environments outside of the bathroom, (such as the beach or garden) it is important to rinse it after every use so that it is free from any particles/obstructions that could affect its working mechanisms. For reconnecting floorsitter to seat please refer to Section 09.2.6

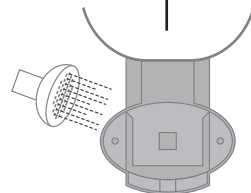
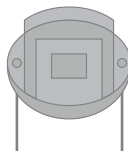
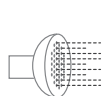

SECTION 06: Product Inspection and Servicing

We recommend that various checks of Splashy BIG are carried out before each use to ensure the product is safe.

The recommended checks are listed below:

1. Ensure that the Splashy BIG back rest and seat base have been **fitted securely together** as detailed in Section 09 of this manual.
2. Check that Splashy BIG is **fixed correctly to the floorsitter base unit** and ensure it is stable and secure in the bath before placing the child in. (NB: Stabiliser is not required for use of Splashy BIG in bath.)
3. Ensure the 5-point harness and bumper supports are **securely fixed** to Splashy BIG using the toggle fixtures.
4. Check the 5-point harness and bumper supports for **any signs of wear or tear**.
5. Check the buckles and toggles for cracks or damage.
6. Check Splashy BIG and Floorsitter latches and connections are clear of dirt or debris with **no signs of wear and tear**.



If you are in any doubt about the safe use of your Firefly product or if any parts should fail, please cease using the product and contact our customer services department as soon as possible.

For all service related issues please refer to the Firefly website **www.fireflyfriends.com** or contact Firefly on **customer.enquiries@fireflyfriends.com**

SECTION 07: Important Guidelines

Ensure that Splashy BIG is sitting securely in the bath. Recline the back rest into a mid-recline position for children who can assist with transfers or are lifted into the bath. Please refer to section 09.6.

Full recline should be used for children who will be hoisted into the bath. This should make transfers into Splashy BIG easier.

We would advise you fit the 5-point harness and bumper supports to Splashy BIG before you place the child into the seat, however, they can be adjusted if necessary once your child is in the bath. Please exercise caution and monitor your child closely whilst alterations are being made to the bath seat.

Lifting a child in and out of the bath is an activity which could cause injury to your back. We would **recommend you seek advice from your therapist** with regards to safe transfers (moving and handling techniques) of your child in and out of the bath.

SECTION 08: Re-issuing Firefly Products

Ensure the product has been cleaned thoroughly in accordance with Section 5 of this manual. Ensure a copy of the user manual is supplied with the product. If in any doubt about the continued safe use of your Firefly product or if any parts should fail, please cease using the product and contact our customer service department as soon as possible on UK 0800 318265 or ROI 1800 626020.

SECTION 09: Instructions for Use

09.1 Splashy BIG Parts

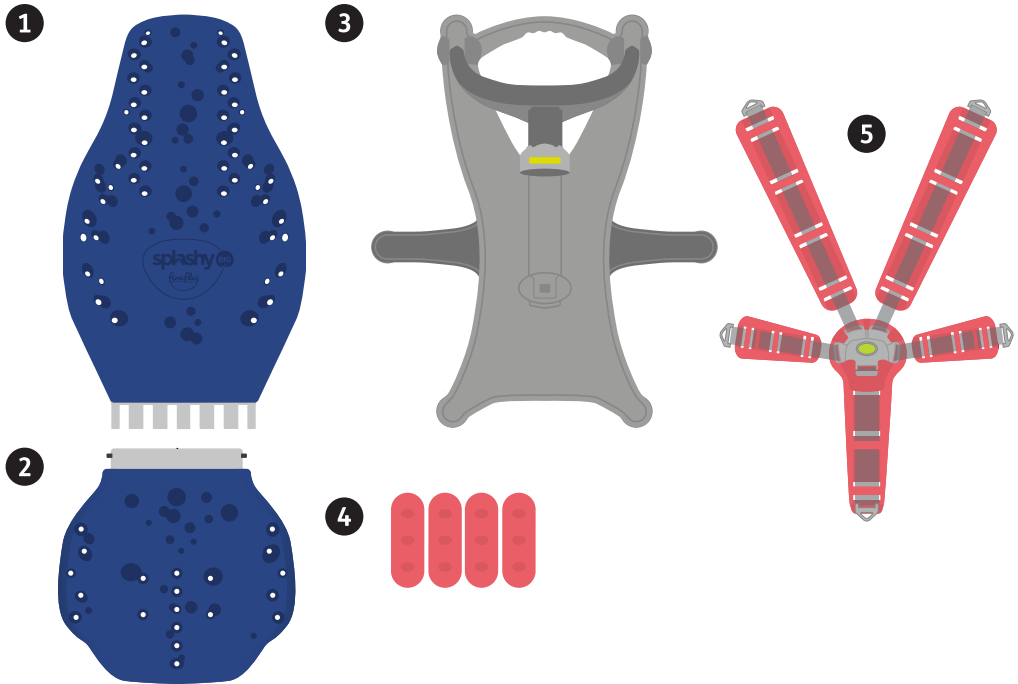

Your Splashy BIG will arrive with the following parts:

- 1 1x Back rest
- 2 1x Seat base
- 3 1x Floorsitter base unit
- 4 4x Bumper supports
- 5 1x Groin strap & 4x Harness straps

09.2 Assembling Splashy BIG

- We highly recommend that you complete a ‘dry run’ with your child in Splashy BIG whilst wearing light clothing to ensure correct placement of harness and bumper supports.
- Make sure your bath is clean and free from any residue before placing the floorsitter into the bath.
- Your Splashy BIG **MUST** be assembled **BEFORE** filling the bath with water. We recommend you fill the bath with a mixture of hot and cold water to prevent damage to Splashy BIG.
- See section 09.6.1 for some guidance on how to position the recline arm on the Splashy BIG.

09.2.1 Placement of the floorsitter

The floorsitter should always be placed on a firm, solid, static surface. When placing the floorsitter on your chosen surface, it's vital that all rubber feet are in contact with the surface. Whilst the stabiliser is not needed when using the Splashy BIG in the bathtub, it is important to ensure it is fully rotated to its, “locked”, position when outside the bathtub.

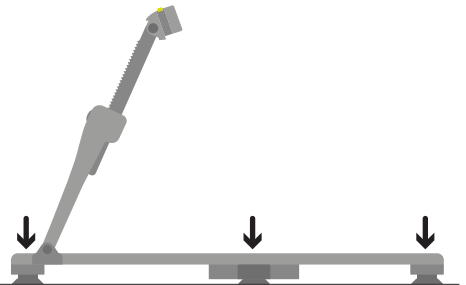

Continued →

09.2.2 Using stabiliser function



Always use the stabiliser when Splashy BIG is being used outside the bath to limit any risk of tipping.

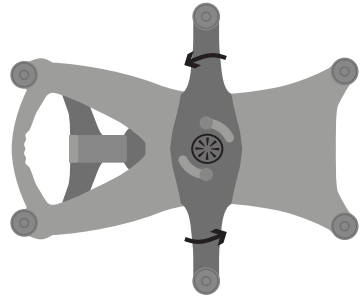

Listen for audible click when locking stabiliser

09.2.3 Placement of the floorsitter

Once the floorsitter is in place, ensure the recline arm is set to its highest position.

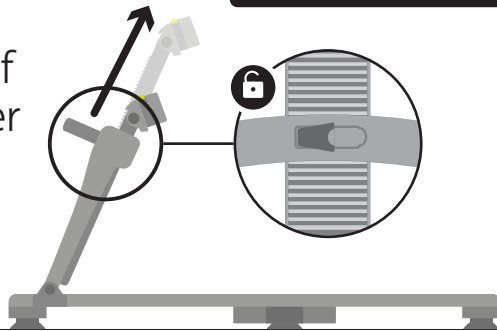

09.2.4 Assembling the Splashy BIG seat

1

Before attaching Splashy BIG to the floorsitter, the back rest and seat base must be assembled.

2

Hold the backrest of Splashy BIG up vertically with the grooves at the top. Use your other hand to slot the seat base into the grooves on the backrest.

Flip the seat base in the opposite direction to lock the connection together. Once connected insert the hinge foam flap underneath the foam backrest cover.

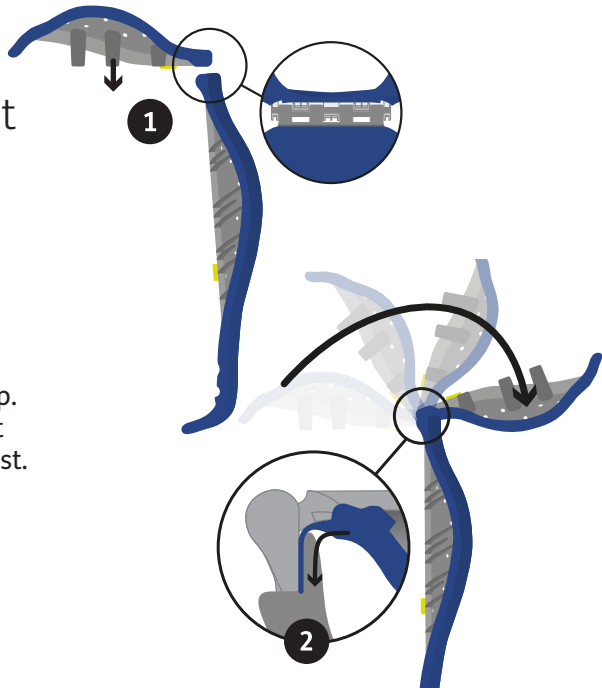

09.2.5 Attaching & configuring the harness & bumpers

- 1** To attach any of the support straps and bumpers onto Splashy BIG's seat base and back rest place the relevant toggle through the hole.
- 2** Secure by turning the toggle sideways underneath the seat.

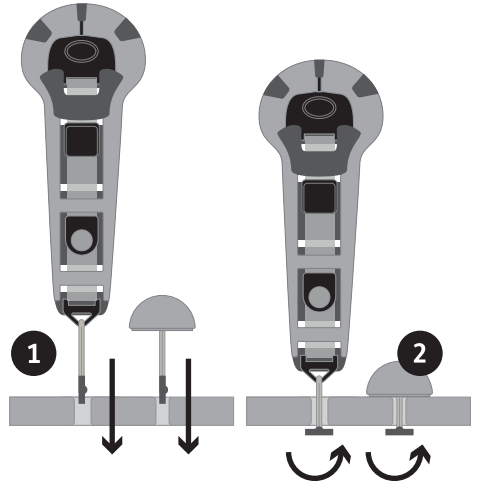

To connect the shoulder and lateral straps, follow this diagram.

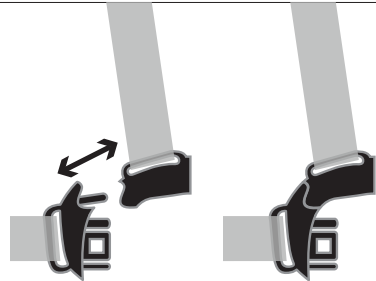

To ensure you are placing the straps in the correct side of Splashy BIG, the buckle should appear as pictured.

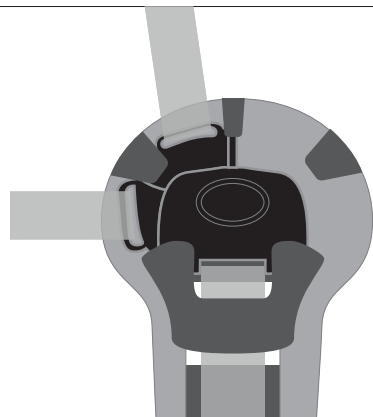

09.2.6 Configuring 5 point harness

- 1 Insert toggle of the groin strap into Splashy BIG seat base.
- 2 Insert the toggle of the left shoulder strap through the hole at the correct height for your child.
- 3 Insert the toggle of the left lateral strap into a hole on the side panels of the back rest.
- 4 Repeat the process for the right shoulder and lateral straps.
- 5 Once all the straps are securely in place, connect all the straps together using the buckle to create a 5 point harness.
- 6 The straps can be fully adjusted by releasing the clamp, making the strap tighter or looser depending on requirements. Please ensure the clamp is closed once the strap has been adjusted.

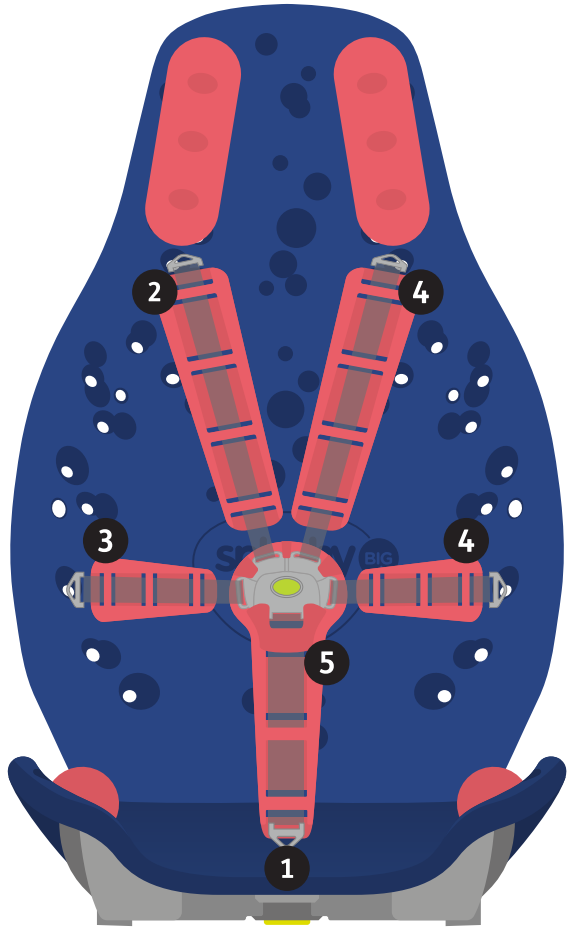

Tip – When happy with adjustment you can thread the remaining section of the strap through the foam section of the harness to keep it tidy.

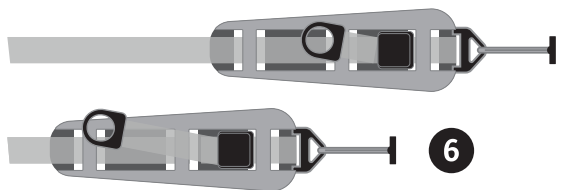

09.2.7 Configuring 3 point harness

- 1** Insert the toggle of the left lateral strap into a hole on the side panels of the back rest.
- 2** Repeat the process for the right lateral strap.
- 3** Once all the straps are securely in place, connect all the straps together using the buckle to create a 3 point harness.

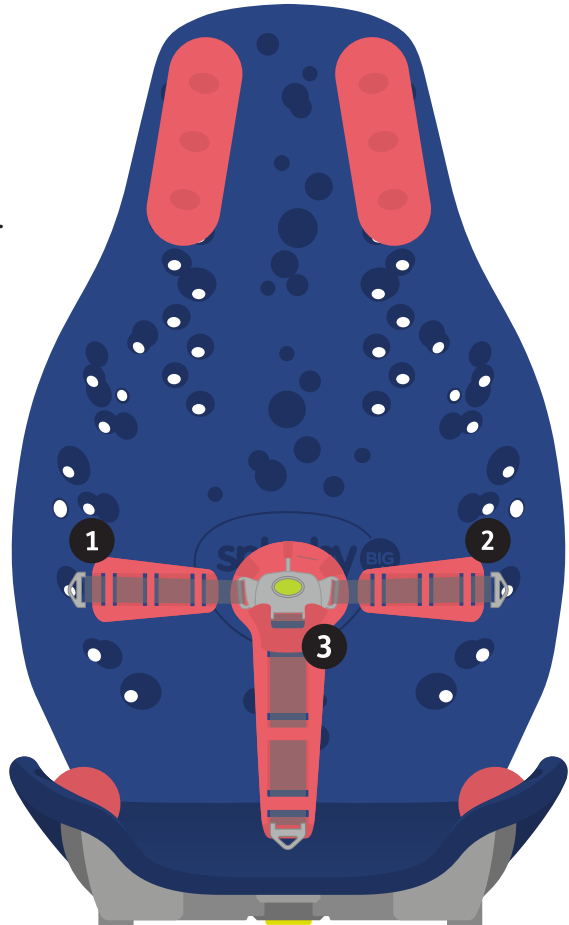



Do not adjust configuration from a 5 point harness to a 3 point harness while the child is in the bath seat.

09.2.8 Fitting Splashy BIG seat to the floorsitter

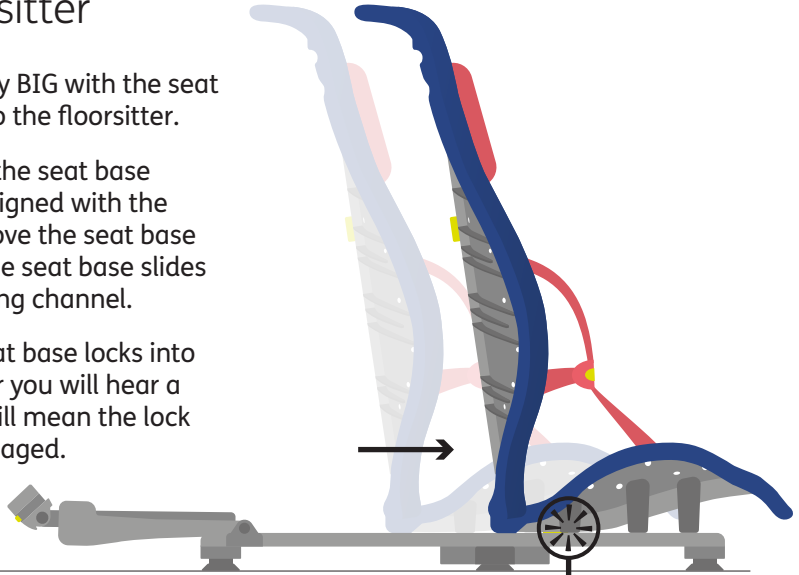
- 1 Lower Splashy BIG with the seat base flat onto the floorsitter.
- 2 Making sure the seat base is centrally aligned with the floorsitter move the seat base forward so the seat base slides into the locking channel.
- 3 When the seat base locks into the floorsitter you will hear a click which will mean the lock has been engaged.



 Listen for audible click when engaging both seat base and seat back to the floorsitter.



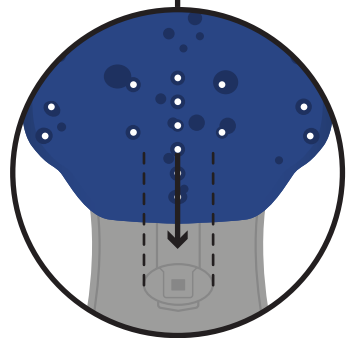

Before attaching the recline arm to the backrest, ensure that it is at the highest setting.

Once attached correctly, you will hear a click.

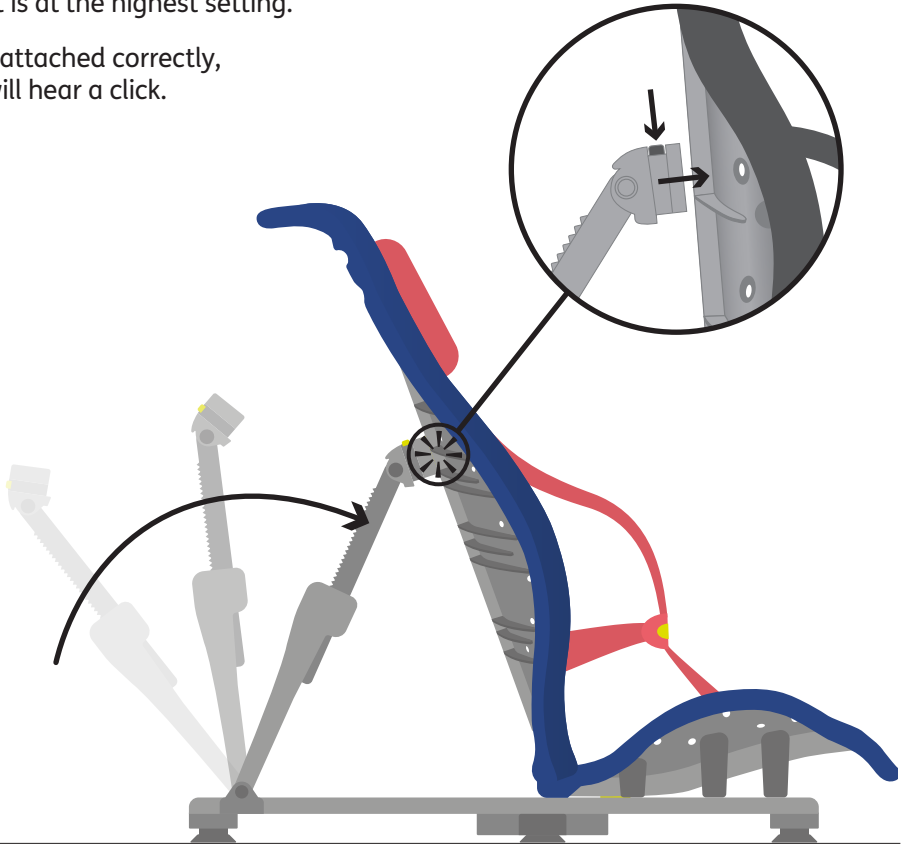

This picture shows what the bath seat should look like when it is fully assembled.

It is now safe to put your child into Splashy BIG.

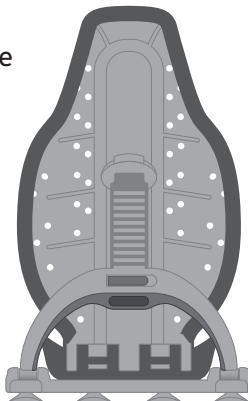

09.3 Bumper Supports

If you feel your child requires further support in Splashy BIG, extra bumpers can be purchased from the Accessories section of the Firefly website.

www.fireflyfriends.com/uk/our-products#accessories



09.3.1 Adjusting the bumpers to provide support in various places

The bumpers can be used as:

1. Head supports – place a bumper on the right and left side of your child’s head.

2. Neck support – place a bumper sideways at the nape of your child’s neck.

3. Pommel – place a bumper between your child’s legs (helps to prevent criss crossing).

4. Leg guides – place a bumper on the right and left side of your child’s legs (helps to prevent them falling over the side of the bath seat).

5. Anti-slide shelf – place a bumper sideways on the base of the bath seat in front of your child’s bottom (helps to prevent your child’s bottom from sliding forward in the seat). Some children may find sitting in Splashy BIG more comfortable if a bumper is placed in front of the groin strap.

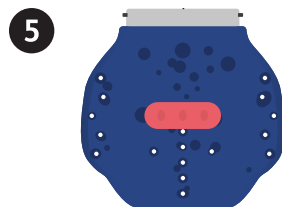
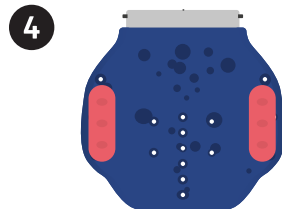
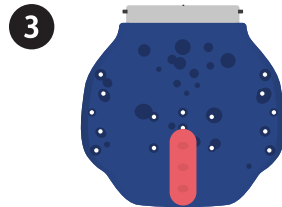
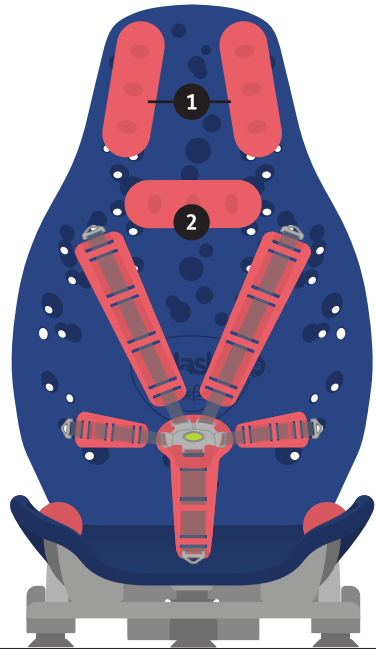

09.4 Adjusting the harness for washing

Remove a shoulder strap to make a 4 point harness to increase access for washing.

To remove the shoulder strap, release the toggle from the reverse of the backrest.



Remove a lateral strap to make a 4 point harness to increase access for lower half washing.

To remove the lateral strap, release the toggle from the reverse of the backrest.



09.5 Shortening lateral and shoulder straps

In some cases you may want to reduce the size of the lateral and shoulder supports to fit a smaller child using Splashy BIG.

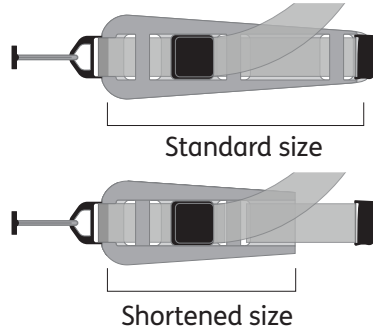

1 When your Splashy BIG arrives, the straps will look like the diagram shown. To adjust the straps to a smaller setting, please follow these instructions.

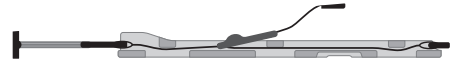

2 Remove the highlighted section of the strap from the foam.

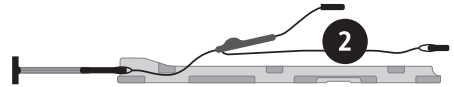

3 Fold the thinner end of the foam backwards and ensure that the openings line up.

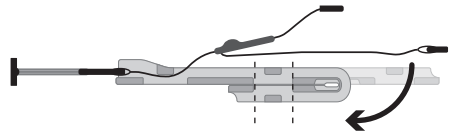

4 Feed the straps through the first opening on the doubled over foam.

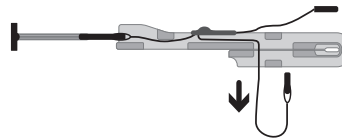

5 Once it has been pulled through completely, feed up through the second opening and pull to tighten.

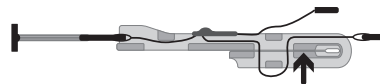

09.5.1 Shortening groin strap

In some cases you may want to reduce the size of the groin strap to fit a smaller child using Splashy BIG.

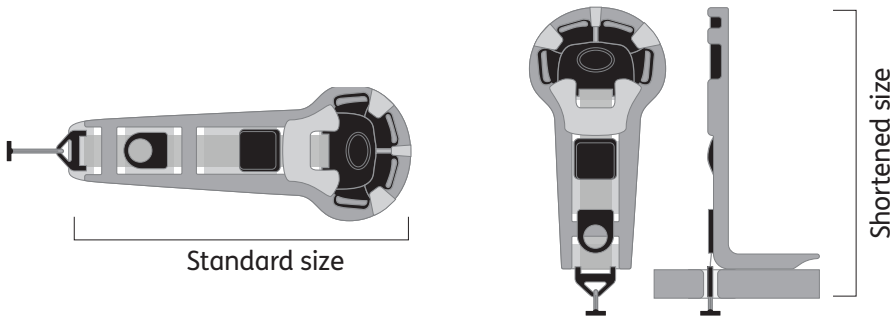

1 The groin strap will look as the diagram shows when it arrives. To adjust the straps to a smaller setting, please follow these instructions.

2 Remove the highlighted section of the strap from the foam.

3 Fold the foam backwards to create a smaller groin strap and feed toggle back through seat base hole.

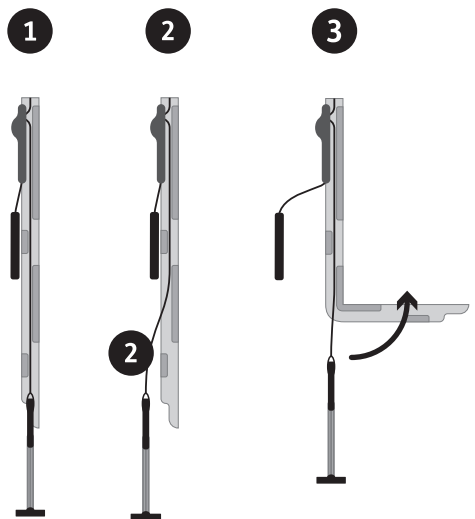

09.6 Recommended recline positions

Upright position – if your child has good sitting tolerance and trunk control, they may be able to use an upright sitting position.

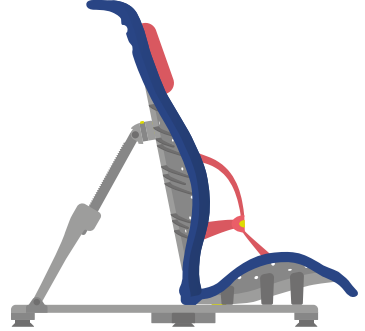

Mid recline position – we recommend that Splashy BIG is placed into a mid recline position if your child is being lifted into the bath seat.

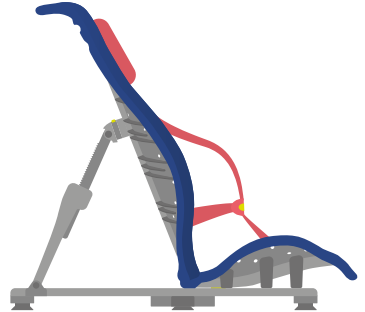

Full recline position – we recommend that Splashy BIG is placed into the full recline position for ease of transfer if your child is hoisted into the bath seat.

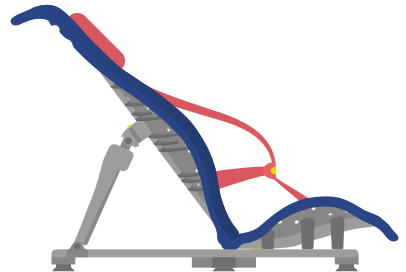

09.6.1 Using the Splashy BIG recline function

Once your child is fully secure and supported, the Splashy BIG recline function can be used.

Exercise caution when altering the recline angle. You should aim to make this movement as smooth as possible to reduce any anxiety the child may have.

To bring Splashy BIG in to a more upright position, place one hand onto the Splashy BIG handle **A** at the top of the backrest for support, and the other hand onto the green clip on the recline arm of the floorsitter. **B**

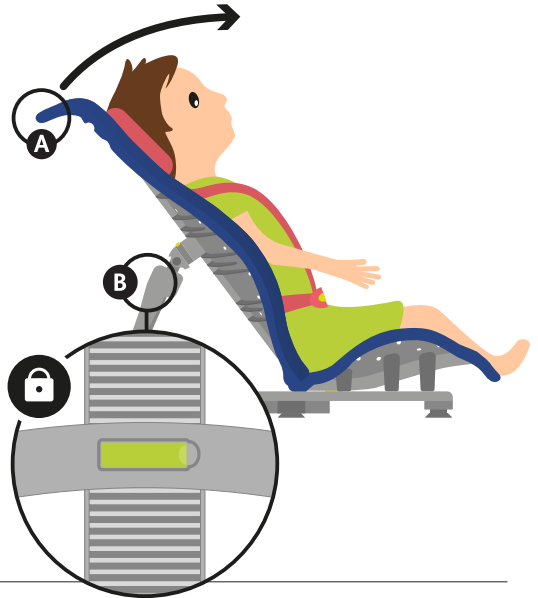

Release the clip and bring the bath seat into an upright position that is suitable for your child. **A**

Fasten the clip on the floorsitter. You will hear a click once fully engaged.

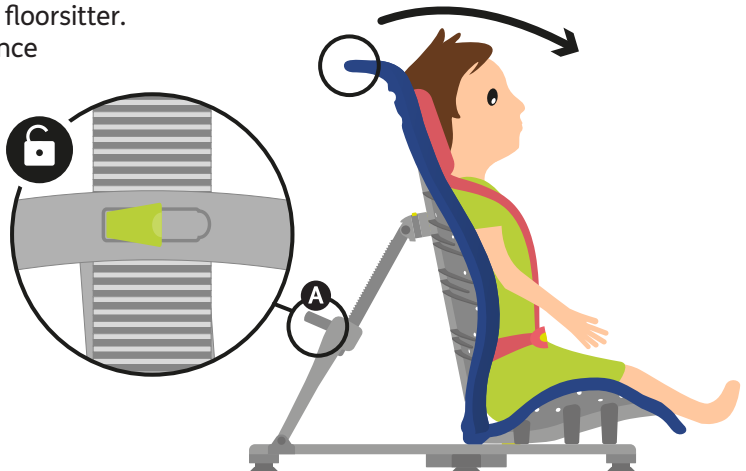

09.7 Removing Splashy BIG from the bath after use and dismantling

Do not remove Splashy BIG from the bath before disengaging seat base and floorsitter as this may put strain on the connections.

Release and remove the child from Splashy BIG and drain the bath.



See Section 7 for guidance on how to do this safely.

To release Splashy BIG from the floorsitter, press the green button on the recline arm and pull the back rest forward.

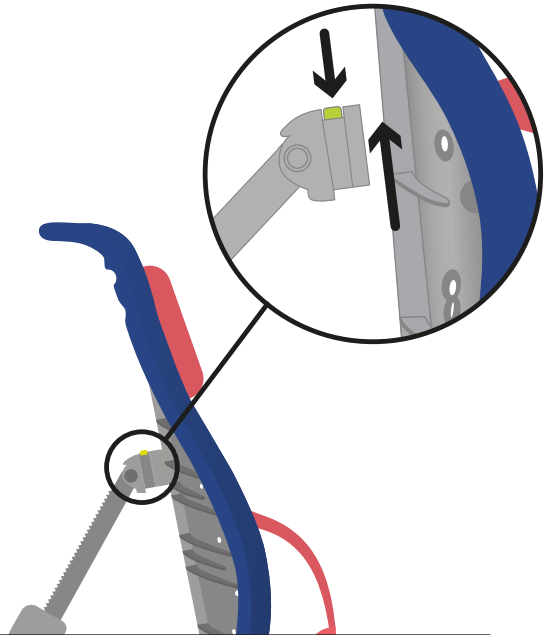

To release the seat base, **A** pull on the green plastic tab and slide backwards, then **B** lift Splashy BIG off the floorsitter.

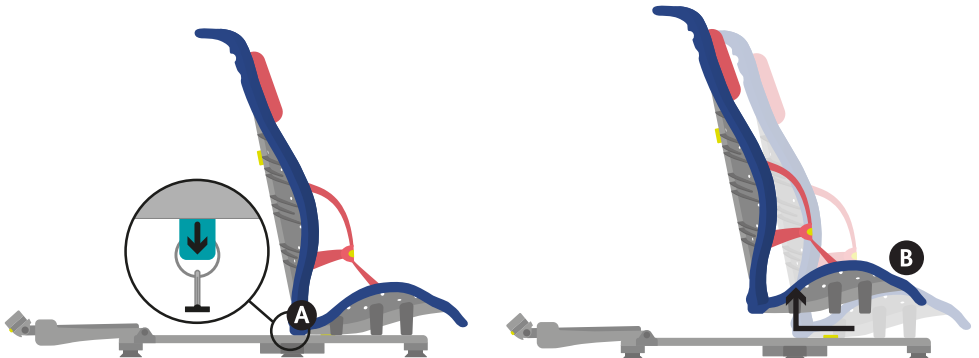

Ensure you do not force the frame from the bath as this may put strain on the connections.

To remove the floorsitter from the bath, gently slide your hand under the rubber feet and they will release.

(do not use tools)

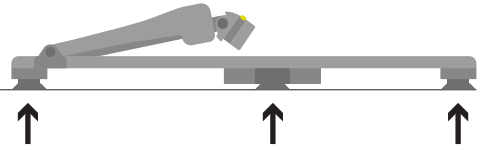

Place Splashy BIG on its side and detach the seat base from the back rest by lipping the seat base back on itself to release the hinge mechanism.

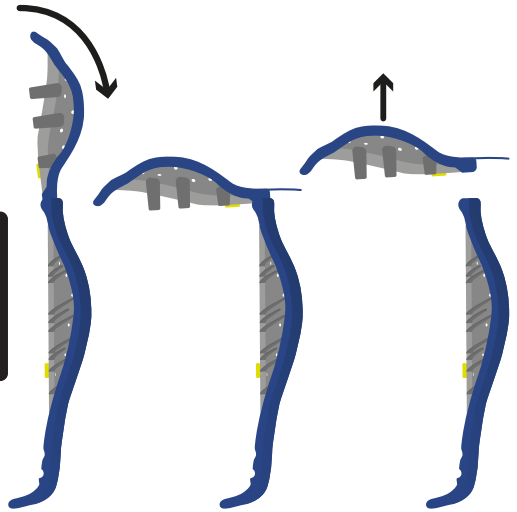

Failure to follow these instructions may invalidate your warranty.

09.8 Draining and drying

Always ensure that you wipe/wash down Splashy BIG before allowing it to drain and store away.

The floorsitter can be wiped dry. (Refer to Section 05 for further guidance.)



For storing floorsitter when not in use, please slide recline arm down to lowest setting and lay flat.

09.9: Floorsitter Outdoor Feet



- 1 Remove the 6 suction cup feet from the floorsitter.



- 2 Add the outdoor feet by screwing in clockwise.

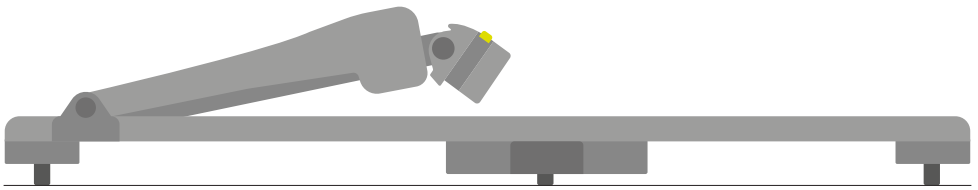

- 3 Make sure all feet engaged and floorsitter is lying flat.



Do not use outdoor feet in the bath/shower. Please use original floorsitter suction cup feet.

10: Sizing Information

Splashy BIG bath seat technical information	
Seat backrest height	720mm (28.5 inches)
Seat backrest width	450mm (17.5 inches)
Seat base depth	400mm (15.5 inches)
Seat base width	450mm (17.5 inches)
Floorsitter width	420mm (16.5 inches)
Floorsitter width with stabiliser	665mm (26 inches)
Floorsitter length	795mm (31 inches)
Maximum weight	55kg (121lbs)
Age range	7-14 years old



Firefly Friends Ltd
19c Ballinderry Road
Lisburn BT28 2SA
Northern Ireland

(+44) 28 9267 8879
hello@fireflyfriends.com

fireflyfriends.com



LS594-02

