

karma

A Better Wheelchair, A Better Fit

Manual Wheelchair Owner's Manual

KM-BT10



ISO 9001

GENERAL WARNING

IMPORTANT

Due to the change of design, some illustrations and pictures in this owner's manual may not correspond to the wheelchair that you purchased. KARMA reserves the right to make design modifications without further notice.



WARNING:

- Do not operate this wheelchair before first reading and understanding this owner's manual. If you are unable to understand the warnings, cautions and healthcare professional or technical instructions, contact a dealer, personnel if applicable before using this wheelchair—otherwise, injury or damage may occur. If there's any procedures other than those described in this owner's manual, it must be carried out by a qualified technician.

General Warning

- DO maintain your wheelchair well, in particular check the tire pressure since this affects the efficiency of the brakes. To know the correct tire pressure, please see the walls of the tires.
- DO make sure both of the manual brakes are applied before getting in or out of the wheelchair.
- DO make sure both of the manual brakes are applied when the wheelchair is not being pushed or used.
- DO take care when climbing kerbs or turning on slopes.
- DO avoid steep or uneven surfaces that may cause the wheelchair to tip over.
- DO avoid soft surfaces as the casters may become bogged down.
- DO travel smoothly in all conditions.
- DO look well ahead to anticipate hazards such as furniture, doors, potholes, etc.
- DO make sure that both user's feet are safely on the footrests and the clothing is safely tucked out of the way so that it cannot get caught in the wheels.
- DO take care when traveling up or down or across inclines.
- DO keep both hands on the push handles to control the wheelchair, if you are the attendant.
- DO pay attention to keep the wheelchair balanced.
- DO check the frame and components regularly and refer to this owner's manual during and after the warranty period.

-
- DO tie-up the upholstery or replace it with a new one when it becomes loose.
 - DO lubricate the bearings regularly.
 - DO equip with anti-tippers to avoid falling backwards.
 - DO equip with a seat belt designed for disabled users.
 - DO equip with "heel loops" for disabled users.
 - DO clean both hands after oiling the wheelchair.
 - DO keep far away from flame.
 - DO NOT overload the wheelchair in any circumstance.
 - DO NOT hang anything heavy on the back of the wheelchair that could cause the wheelchair to become unstable, particularly when negotiating inclines.
 - DO NOT allow more than one user at a time.
 - DO NOT have any unconscious patient use the wheelchair.
 - DO NOT use other transport to pull the wheelchair.
 - DO NOT do "wheelies", since you might fall or tip over backwards and suffer a severe injury.
 - DO NOT sit in the wheelchair within a moving vehicle unless it has been affixed the labels of hook mark.
 - DO NOT go too fast or turn too quickly.
 - DO NOT stand on the footplates when getting in or out of the wheelchair.
 - DO NOT go down steps forward, whether solo or with an attendant.
 - DO NOT attempt to lift the wheelchair by any removable (detachable) parts. Lifting by means of any removable (detachable) parts of the wheelchair may result in injury to the user and/or assistant or damage to the wheelchair.
 - Do NOT use the wheelchair when the back is folded. This alters the center of gravity and may cause the wheelchair to tip backwards. The back should only be folded for storage or transport of the wheelchair.
 - DO NOT hang anything on the back joint that could cause the backrest folding suddenly and may cause injury.
 - DO NOT hang any heavy stuff on the backrest joint or the back of the wheelchair. It could let the backrest fold suddenly, become unstable and hurt the user or the attendant, particularly when negotiating inclines.

YOU AND YOUR KARMA SERVICE PROVIDER

- No tools are required for assembly. Your wheelchair should be assembled by your authorized KARMA dealer. Your authorized KARMA dealer is also your service provider. Unauthorized repairs, upgrades and add-ons will void your warranty. Anything wheelchair related that requires tools should be done by your authorized KARMA service provider. Your KARMA service provider has the necessary service/maintenance manual for your wheelchair.

-
- If you have any defective parts or lose any parts, please contact your dealer for repair and/or replacement. Please only use parts authorized by KARMA. Use of parts that are not authorized by KARMA will void your warranty.
 - Part numbers are listed on our bill of materials (explosion drawings), which we give to our authorized dealers and service providers. Customers should order parts through their dealer as well as all repairs and scheduled maintenance.
 - Customers should go to their dealer for all service needed to guarantee their warranty is not void. Always go to an authorized service provider. Unauthorized repairs will void your warranty. Procedures other than those described in this manual must be performed by a qualified technician. They also have the service manual with a complete list of maintenance required to keep your KARMA wheelchair in top performance. Check the warranty section of this manual to find out what KARMA guarantees and what maintenance and parts that are not covered by our warranty.
 - KARMA does not have an official list of service providers at this time. Please contact your dealer for service. If you cannot contact your dealer, please contact another authorized KARMA dealer for service. If all else fails, contact KARMA directly via our website or give us a call and we can refer you to your new service provider.

CE MARKING

- This wheelchair complies with the requirements of the Medical Devices Directive 93/42/EEC.



CAUTION:



- **When prescribing wheelchairs for use by full or partial amputees (above or below knee, single or double) or other conditions that affects the user's natural center of gravity and might cause the wheelchair to tip or the person on the wheelchair to fall off, we suggest contacting your therapist or dealer as well as attaching anti-tippers, pelvic belt, or other additional safety accessories.**
- **When using the wheelchair, ALWAYS follow the Highway Code or your local traffic regulations when outdoors and the guidelines written in this manual.**

TABLE OF CONTENTS

1. PREFACE	1
2. SAFETY	2
2.1 Before Using	2
2.2 While Moving	2
2.3 Maximum User Weight Limit.....	4
2.4 Labelling	5
3. INTENDED USE & PARTS	6
3.1 Intended Use	6
4. OPERATION	8
4.1 Preparing For Use	8
4.2 Transferring In and Out.....	21
4.3 General Use.....	22
5. INSPECTION AND MAINTENANCE.....	26
5.1 General Check	26
5.2 Regular Maintenance Record	26
5.3 Adjustment Manual	29
6. ACCESSORIES.....	33
7. TROUBLESHOOTING.....	34
8. SPECIFICATIONS	35
9. CLEANING & RECYCLING.....	36
9.1 Cleaning	36
9.2 Recycling	37
10. WARRANTY	37
10.1 Serial Number.....	37
10.2 Warranty Policy	37

1. PREFACE

- 1.1 Please read this owner's manual carefully before using the wheelchair. Any improper use of the wheelchair may result in harm or injury.
- 1.2 This owner's manual includes operation, unfolding/ folding instructions and how to prevent possible accidents for the aspects of the wheelchair.
- 1.3 This owner's manual is written for KARMA wheelchair: KM-BT10.
- 1.4 The symbols used in this manual are explained below. Pay special attention to the parts marked with them.

 WARNING:	Improper use could lead the user to severe injury or death.
 CAUTION:	Improper use could lead the user to severe injury and/or damage to your wheelchair.
 SUGGESTION:	Follow these instructions to keep the wheelchair in good condition.

- 1.5 This manual includes an inspection and maintenance chart as well as the details of the warranty.
- 1.6 If someone else uses the wheelchair, make sure that you have given him or her this owner's manual for reference.
- 1.7 Due to the change of design, some illustrations and pictures in this manual may not correspond to the wheelchair that you purchased. KARMA reserves the right to make design modifications without further notice. This manual will be updated regularly. Please refer to the KARMA website for the latest version.
- 1.8 Please note that this "Owner's Manual" contains a number of cautions -any vehicle can cause injury if misused - use within our guidelines and with reasonable care and your safety will be increased. Your wheelchair will give years of safe use if used sensibly and carefully. Be aware that careless use endangers your own safety as

well as that of others

2. SAFETY

2.1 Before Using

The user and the attendant must be familiar with the operation of the wheelchair before using. Pedestrian traffic rules apply to the wheelchair. Please be safe.

2.2 While Moving

Please always keep the safety guidelines listed below in mind.

2.2.1 Doorways

2.2.1.1 The safest way to operate the wheelchair is on level floors that are free of obstacles. If possible, always use a ramp to enter or exit a facility. Keeping your hands on the push rims will allow you to maintain the maximum balance.

2.2.1.2 DON'T try to force yourself over an obstacle and use the sides of a doorway to pull yourself through a passageway.

2.2.2 Leaning and Standing

DON'T lean over the side, stand or play on the wheelchair because it may let you lose balance and fall down. (See Figures 2.1 and 2.2)



Figure 2.1



Figure 2.2

2.2.3 Negotiating Inclines

2.2.3.1 Always negotiate inclines with an attendant as far as possible.

2.2.3.2 When an attendant is pushing the wheelchair straight up a

slope, if the user needs to go down midway on the slope, walk backwards until the user is on level ground (See Figures 2.3 and 2.4)



Figure 2.3



Figure 2.4

2.2.3.3 DO avoid stopping on an incline, it may let you lose the control of the wheelchair.

2.2.3.4 DON'T use the manual brakes to slow down or stop the wheelchair, this could cause it to seize up and make the user to lose control or fall out of the wheelchair.

2.2.3.5 Operating limits: DON'T attempt to go down inclines without any assistance, whose angle is greater than 7 degrees.

2.2.4 Streets and Kerbs

2.2.4.1 Always cross streets with great caution. Reflective tape on the wheelchair and/or your clothing will make you more visible to drivers.

2.2.4.2 Keep away from potholes and rough terrain that might cause the casters to get stuck. (See Figure 2.5)

2.2.4.3 DO avoid huge impacts when descending a kerb. A huge impact could probably damage the wheelchair.

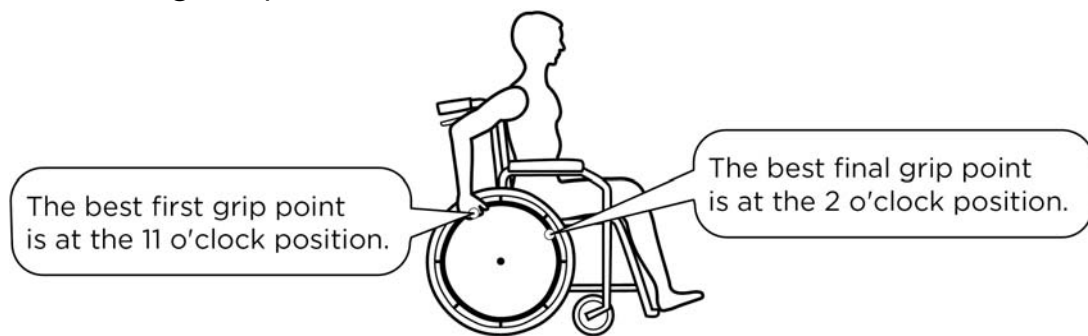

Figure 2.5

2.2.4.4 Never try to climb/ descend a kerb that exceeds a normal height (30-50 mm).

2.2.4.5 Always be careful and never move up or down a kerb in reverse without an attendant.

2.2.4.6 When the user is operating the wheelchair using the pushrims, please push the wheelchair gently. DO NOT apply a sudden huge force on the pushrims. It could cause the chair to tip over. Please refer to the figure below for the best grip points for using the pushrims.



WARNING:

- Any improper use of the wheelchair could cause severe injury or death.
- For increasing your safety, please make sure that you have realized those guidelines as mentioned previously.

2.3 Maximum User Weight Limit

2.3.1 The maximum user weight limit for KM-BT10 is 250 kg. For detail information, please refer to Section 8. SPECIFICATIONS.

2.3.2 Please note that loading exceeding maximum capacity can damage your wheelchair and cause malfunctions, which leads to a safety hazard. The warranty does not cover the damage caused by improper operation of the wheelchair.

2.4 Labelling

Please carefully read all the labelling on the wheelchair before using it. Do not remove them and protect them for future reference.



Model:	
Order No.:	
Delivery Date:	
Sewing No.: 1 <input type="checkbox"/> 2 <input type="checkbox"/> 3 <input type="checkbox"/> 4 <input type="checkbox"/> 5 <input type="checkbox"/> 6 <input type="checkbox"/>	
Seat Width	Seat Depth
<input type="checkbox"/> 13	<input type="checkbox"/> 13
<input type="checkbox"/> 14	<input type="checkbox"/> 14
<input type="checkbox"/> 15	<input type="checkbox"/> 15
<input type="checkbox"/> 16	<input type="checkbox"/> 16
<input type="checkbox"/> 17 . <input type="checkbox"/> 0	<input type="checkbox"/> 17 . <input type="checkbox"/> 0
<input type="checkbox"/> 18 . <input type="checkbox"/> 5	<input type="checkbox"/> 18 . <input type="checkbox"/> 5
<input type="checkbox"/> 19	<input type="checkbox"/> 19
<input type="checkbox"/> 20	<input type="checkbox"/> 20
<input type="checkbox"/> 21	<input type="checkbox"/> 21
<input type="checkbox"/> 22	<input type="checkbox"/> 22
<input type="checkbox"/> _____	<input type="checkbox"/> _____
karma	Unit: inch

3. INTENDED USE & PARTS

3.1 Intended Use

- 3.1.1 The KM-BT10 is a self-propelled or transit wheelchair. That is, it can either be propelled by an attendant (transit) or by the user (self-propelled).
- 3.1.2 The KM-BT10 is suitable for users up to 250 kg in weight.
- 3.1.3 The KM-BT10 is an adjustable wheelchair. The detachable parts are easy to operate.
- 3.1.4 The casters are equipped with PU tyres for greater durability.
- 3.1.6 Spoke rear wheels are 24 inches in diameter for standard equipment.
- 3.1.7 When equipped with anti-tippers, KM-BT10 could help full or partial amputees (above or below knee, single or double) or other conditions easily maintain their natural center of gravity, which could effectively avoid the user from tipping over backwards.
- 3.1.8 Flip-back & height adjustable armrest is available as optional for the KM-BT10:.

3.2 KM-BT10 Parts Description



- 1. Push Handle
- 2. Attendant Brake
- 3. Side Panel
- 4. Rear Wheel
- 5. Anti-Tippers
- 6. Manual Brake
- 7. Cross Brace (Cross Bar)

- 8. Caster
- 9. Backrest Cushion
- 10. Armrest
- 11. Seat Cushion
- 12. Calf Strap
- 13. Footplate

4. OPERATION

4.1 Preparing For Use

4.1.1 Unfolding

While unfolding the KM-BT10, follow these instructions as listed below:

- 4.1.1.1 Stand at the side of the wheelchair as you prefer, hold the armrests and pull outwards. (See Figure 4.1)
- 4.1.1.2 Put your two hands on the seat pan and press it down until it is fully lowered, be careful not to get your fingers caught. (See Figure 4.2)
- 4.1.1.3 Pull up the rigidifying push-bar (See Figure 4.3)
- 4.1.1.4 Lift up the rear part of the wheelchair lightly, and use your stronger foot to tread on the cross bar until it is fixed and doesn't shake. (See Figure 4.4)
- 4.1.1.5 Flip the footplates down. (See Figure 4.5)
- 4.1.1.6 Attach the calf strap. (See Figure 4.6)
- 4.1.1.7 Place the back and seat cushion on the wheelchair.
- 4.1.1.8 Ready for action!



Figure 4.1



Figure 4.2



Figure 4.3



Figure 4.4



Figure 4.5



Figure 4.6

 **WARNING:**

- The primary function of the rigidifying push-bar is to maintain and avoid deforming of the backrest, which could cause the user to be discomfort.
- Never use the rigidifying push-bar to push or pull the wheelchair, or it may lead to fracture and cause severe injury to the user.

4.1.2 Folding

While folding the KM-BT10, follow these instructions as listed below:

4.1.2.1 Remove the back and seat cushions from the wheelchair.

(See Figure 4.7)

4.1.2.2 Detach the calf strap. (See Figure 4.8)

4.1.2.3 Flip up the footplates. (See Figure 4.9)

4.1.2.4 Release the knob bolt at the middle, then push down the rigidifying push-bar. (See Figure 4.10)

4.1.2.5 Lift up the front part of the wheelchair lightly, grasp the middle lever of the seat pan, apply an upward force and simultaneously use your stronger foot to tread on the cross bar until the wheelchair is fully closed. (See Figure 4.11)

4.1.2.6 Folding is now completed. (See Figure 4.12)



Figure 4.7



Figure 4.8



Figure 4.9



Figure 4.10



Figure 4.11



Figure 4.12



CAUTION:

- Be careful not to get your fingers caught when folding the wheelchair.

4.1.3 Adjustments

4.1.3.1 Armrest

4.1.3.1.1 Standard: Flip-Back and Detachable Armrest

Flip back the armrest by releasing the knob bolt located at the front base of the armrest. After completing the step, you can lift the armrest backwards. (See Figures 4.13 and 4.14)



Figure 4.13



Figure 4.14

4.1.3.1.2 Optional: Flip-Back, Detachable and Height Adjustable Armrest

- Loosen the knob bolt.
- Adjust the armrest to the desired height.
- Tighten the knob bolt. (See Figure 4.15 and 4.16)



Figure 4.15



Figure 4.16

4.1.3.2 Backrest

4.1.3.2.1 Backrest Height

To adjust the backrest height, follow the instructions listed below:

- Detach the armrest and backrest upholstery first.
- Use the KARMA tool provided to loosen the screws at both of the bottom sides of the backrest frame.
- Adjust the backrest to the desired height.
- Tighten the screws, attach the armrest and backrest upholstery to the original condition.
- Backrest height adjustment is now completed. (See Figure 4.17 and 4.18)



Figure 4.17



Figure 4.18

4.1.3.2.2 Backrest Angle Adjustment

To adjust the backrest angle, follow the instructions listed below:

- Detach the armrest and remove the backrest upholstery first.
- Use the KARMA tool provided to loosen the screws at both of the bottom sides of the backrest frame.
- Remove the screw and the backrest adjustable plate.
- Adjust the backrest forward or backward to the position as desired.
- Re-tighten the screw and backrest adjustable plate.

-
- Place the armrest and backrest cushion back to the seat.
 - Backrest angle adjustment is now completed. (See Figure 4.19 and 4.20)



Figure 4.19



Figure 4.20

4.1.3.3 Seat

4.1.3.3.1 Seat Depth

To adjust the seat depth, follow the instructions listed below:

- Remove the two rear wheels, and put the frame down gently.
- Remove the two rear wheel bases, and then use the KARMA tool provided to loosen the screws at the bottom of the seat bracket.
- Use the KARMA tool provided to loosen the screws at the bottom of the armrest base.
- Adjust the seat bracket and the armrest base forwards/backwards to the desired position.
- Tighten the screws, attach the armrest and backrest upholstery to the original condition.
- Seat depth adjustment is now completed. (See Figure 4.21 and 4.22)

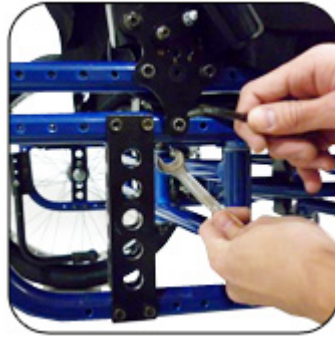

Figure 4.21

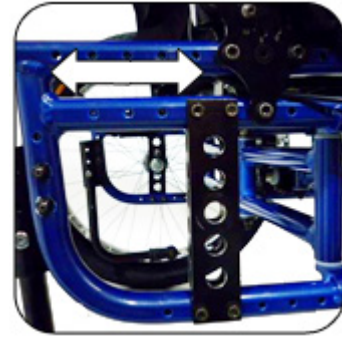

Figure 4.22

4.1.3.4 Rear Wheel

Quick-release wheels are available as optional. Please follow the instructions listed below.

4.1.3.4.1 Rear Wheel Disassembly

- Ensure that the manual brake is in the unlocked position first.
- Support the weight of the chair with one hand by holding the push handle.
- Depress the hub cover and hold down the quick-release mechanism.
- Remove the wheel. (See Figure 4.23)

4.1.3.4.2 Rear Wheel Assembly

- Ensure that the manual brake is in the OFF (unlocked) position first.
- Take up the assembled wheel and axle and depress the button in the centre of the axle as mentioned above.
- This retracts the ball bearings that will allow you to push the axle into the wheel bracket that is located on the lower rear frame of the wheelchair.
- When you remove your thumb from the button on the axle, the ball bearings should be visible protruding from the axle at the back of the wheel bracket. This will secure the wheel safely in the frame. (See Figure 4.24 at the next page)

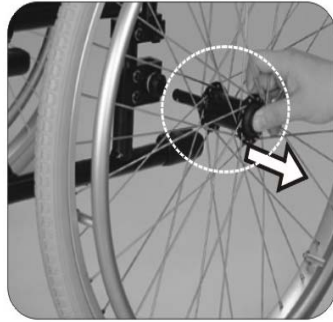

Figure 4.23

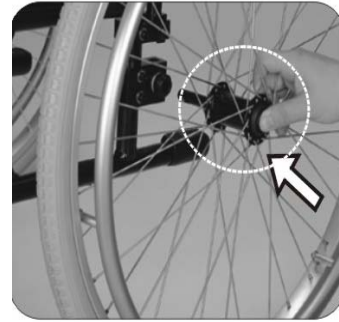

Figure 4.24



CAUTION:

- You must make sure that the axle is fully located in the wheelchair bracket and that the ball bearings are fully open and have positively attached the wheel in the frame.
- The rear wheel can be mounted at different positions on the frame to alter the seat height and overall stability of the chair. Changing the wheel position should be carried out by authorized dealer or qualified therapist.

4.1.3.4.3 Important Do's and Don'ts

- DO keep the axles clean and lubricated with light oil or maintenance spray.
- DO maintain the correct tyre pressure if using pneumatic tyres.
- DON'T try to remove the wheels while the wheelchair is occupied even when it is equipped with anti-tippers.

4.1.3.5 Footrest

Footrests can be swung away, which makes transferring out easier.

4.1.3.5.1 To remove the footrest, press the release pin first and rotate the footrest until it faces outwards.

4.1.3.5.2 To attach the footrest, locate it on the frame plug at about 90 degrees (perpendicular) to the side of the frame and rotate inwards until you hear a "click"

sound, which means the footrest is fixed on the frame.

4.1.3.5.3 The footplate height must be more than 5cm from the ground level (See Figure 4.25)



Figure 4.25

4.1.3.6 Elevating Footrest (Optional)

4.1.3.6.1 You can elevate the footrest directly and stop anywhere you desired. (See Figure 4.26)

4.1.3.6.2 When you want to go down, press the release lever. (See Figure 4.27)

4.1.3.6.3 To adjust footplate height use the Karma tool provided to loosen the bolt at the side of the footrest arm.

4.1.3.6.4 Adjust to required height and re-tighten. (See Figure 4.28 and 4.29)



Figure 4.26



Figure 4.27



Figure 4.28



Figure 4.29

(i) SUGGESTION:

- Make sure that the footplate height is adjusted properly according to the user's calf length to reduce pressure on the body.
- The footplate height must be more than 5 cm. (See Figure 4.25)

※ The footrests are designed to carry 100 kg each.

4.1.3.7 Footplate

4.1.3.7.1 Height

To adjust the footplate height, follow these instructions listed below.

- Use the KARMA tool provided to loosen the bolt at the end of the footrest arm.
- Adjust to required height and tighten. (See Figure 4.30)
- Make sure that the footplate height is adjusted properly according to the user's calf length to reduce pressure on the body.



Figure 4.30



Figure 4.31

4.1.3.7.2 Longitudinal (Fore/Aft) Position

To fit the occupant's leg position and flexibility, follow the instructions listed below:

- Remove the footplate fastener bolts on each plate.
- Adjust the plate position on the footplate support tube below as desired and,
- Re-tighten the footplate fastener bolts. (See Figure 4.31)

4.1.3.7.3 Lateral (Sideways) Position

To open or close the gap between the footplates, follow the instructions listed below.

- Loosen the footplate fastener bolts on each plate.
- Adjust the plate position as desired and re-tighten the

footplate fastener bolts. (See Figure 4.32)



Figure 4.32



Figure 4.33

4.1.3.7.4 Dorsiflexion and Plantarflexion

For users who have the symptoms of Dorsiflexion and Plantarflexion, follow the instructions listed below to adjust it to the appropriate angle. The range adjustment is +/- 90 degrees. (See figure 4.33)

- Loosen the footplate fastener bolts on each plate.
- Adjust the plate angle as desired and re-tighten the footplate fastener bolts.

4.1.3.8 Pelvic Belt

To adjust the pelvic belt, follow the instructions listed below.

4.1.3.8.1 For KM-BT10, pelvic belt is the standard equipment.

4.1.3.8.2 To adjust the length of the pelvic belt, identify the required length.

4.1.3.8.3 Push the two parts of pelvic belt through the buckle to make the pelvic belt longer or shorter. (See Figure 4.34)

4.1.3.8.4 Pull the two parts of pelvic belt to tighten it.

4.1.3.8.5 Push the buckle up to the plastic clip so that the pelvic belt cannot slip out of position. (See Figure 4.35)

4.1.3.8.6 Please check that there is no gap between the clasp

and the buckle.

4.1.3.8.7 KM-BT10 also provides the extension pelvic belt part to suit the user who has a large body type, just follow the previous step and you can easily attach them. (See Figure 4.36)



Figure 4.34



Figure 4.35



Figure 4.36

i SUGGESTION:

- We recommend that the pelvic belt should be fitted quite tightly around the user's pelvis. Please tighten until you can just get your fingers between the user and the pelvic belt. Please check that the pelvic belt is fastened correctly as recommended. If this is not possible, please consult with your supplier.

4.1.3.8.1 Operation

- When you sit on the wheelchair, always fasten the pelvic belt.
- Adjust the pelvic belt and make it fit your body for comfort and security.
- When the pelvic belt is not used and the wheelchair is in motion, please fasten the pelvic belt to avoid dropping into rear wheels.

4.1.3.8.2 Maintenance

It does not require any maintenance but should be inspected every time when use to ensure that the edges are not frayed. Make sure that it correctly fits

the user. If there are any signs of deterioration, please replace it immediately.

4.1.3.9 Anti-Tippers

4.1.3.9.1 The function of the anti-tippers is to avoid the user falling backwards when sitting on the wheelchair.

4.1.3.9.2 To avoid the attendant stumbling when pushing it forwards/ backwards, be sure to keep the anti-tippers out of the way by treading in clockwise/ counterclockwise directions. (See Figure 4.37 and Figure 4.38)



Figure 4.37



Figure 4.38

4.1.4 Transportation and Storage

Make sure the wheelchair is fully folded when it is kept in storage.

SUGGESTION:

- Please store the wheelchair in a location where it is out of direct sunlight, rain and dew. For more details, consult with your KARMA dealer.

WARNING:

- Don't put anything on the wheelchair while it is in storage. Storing goods on a folded wheelchair will cause damage and is not covered under warranty. (See the figure at the right)

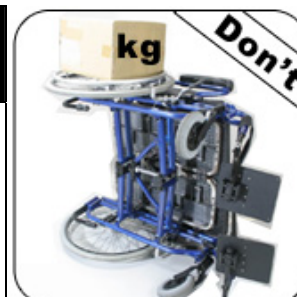

4.2 Transferring In and Out

4.2.1 Transferring In

- 4.2.1.1 Engage both of the manual brakes.
- 4.2.1.2 Turn the footplates up and swing them to the side.
- 4.2.1.3 Lower the user into the seat, allow them to use the armrests for support.
- 4.2.1.4 Turn the footplates back down, so that the user can place feet on them.
- 4.2.1.5 Ensure that the user's heels rest against the heel supports to prevent direct contact from the casters.



CAUTION:

- Always ensure that the front casters are in line with the rear wheels and pointing forwards and that the back of the chair is secure either against a wall or firmly held by an attendant.

4.2.2 Transferring Out

- 4.2.2.1 Make sure that the wheelchair is near the place you are transferring to.
- 4.2.2.2 Back the wheelchair sufficiently to ensure that the casters are pointing forward, i.e. in line with the rear wheels and usually with the caster forks pointing forward. Ensured that, where possible, push the rear side of the wheelchair is against a wall or, if not, it must be firmly held by an attendant.
- 4.2.2.3 Engage both of the manual brakes.
- 4.2.2.4 Turn the footplates up and swing them to the side.
- 4.2.2.5 Slide forwards on the seat.
- 4.2.2.6 Place one foot firmly on the ground with the knee at a right angle and the other foot slightly apart and further back.
- 4.2.2.7 Place your hands on the front of the armrests and moving your weight forward, bring your head and shoulders up over your knees as you push yourself up.

4.2.2.8 DON'T stand on the footplates or do side transfer when getting in or out of the chair. (See Figure 4.39 and Figure 4.40)



Figure 4.39



Figure 4.40



Figure 4.41

4.3 General Use

4.3.1 Attendant Pushing and Self Propelling

4.3.1.1 Ensure that the brakes are always locked when the chair is not being pushed. (See Figure 4.41)

4.3.1.2 Always make sure that both of user's feet are safely on the footplates and that clothing is safely tucked out of the way and cannot get caught in the wheels. (See Figure 4.42)



Figure 4.42



Figure 4.43

4.3.1.3 Always use both hands on the push handles to control the chair. (See Figure 4.43)

4.3.1.4 Always avoid steep or uneven surfaces because the chair may tip over. (See Figure 4.44)

4.3.1.5 Always avoid soft surfaces because the casters may get bogged down. (See Figure 4.45)



Figure 4.44



Figure 4.45

4.3.1.6 Always be careful not to go too fast or turn too quickly and try to achieve a smooth steady ride.

4.3.1.7 Before crossing the road, please stop completely and look both ways.

4.3.1.8 Cross tracks or ruts at the right angle to avoid your casters getting stuck.

4.3.1.9 Please keep your hands and arms inside the wheelchair when going through doorways.

4.3.1.10 Please keep in contact with the person in the chair. If you stop to look in shop windows or talk to people, remember to turn the chair so that the person in the chair does not have to turn.

4.3.1.11 Never lock the brakes too suddenly as this may tip the user out of the wheelchair.

4.3.4 Going Down Kerbs

Please note that it is always better to avoid kerbs where possible by using ramped kerbs or slopes and this operation is best attempted with the aid of an attendant.

4.3.4.1 Going Down Kerbs Forwards With An Attendant

4.3.4.1.1 Position the wheelchair so that the front casters are near the edge of the kerb and make sure that the road is clear.

4.3.4.1.2 Move the wheelchair slowly and carefully forwards

while tilting it back slightly. Be ready to take the weight when the rear wheels cross the kerb edge. Ensure that both rear wheels touch the ground at the same time to avoid tipping the wheelchair.

4.3.4.1.3 Gently lower the front casters. AVOID JARRING THE USER.



CAUTION:

- This is the more difficult method and can jar the user but allows a better view of traffic.
- Be careful that the anti-tipper does not get caught on the kerb causing the user to fall.
- **NEVER ALLOW THE CHAIR TO TIP FORWARDS WHEN GOING DOWN A KERB.**

4.3.4.2 Going Down Kerbs Backwards With An Attendant

4.3.4.2.1 Back the wheelchair to the kerb edge and be careful that the back wheels are equally near the edge.

4.3.4.2.2 Grasping the push handles, gently lower the rear wheels onto the road. Be prepared to control the weight as it descends and ensure that the back wheels touch ground at the same time.

4.3.4.2.3 Tilt the wheelchair back slightly and pull the tilted wheelchair far enough into the road so that the casters and footrests can be lowered clear of the kerb.



CAUTION:

- This is the easier and smoother method, but it requires the attendant to step backwards into the road.

4.3.5 Going Up Kerbs

Please note that this operation is best attempted with the aid of an attendant and the best method is to go up kerbs forwards as this maintains the direction of travel and is

physically less demanding for the attendant.

4.3.5.1 Going Up Kerbs Forwards With An Attendant

4.3.5.1.1 As the footrests nearly touch the kerb tilt the wheelchair.

The wheelchair should be tilted just high enough to allow the front casters to roll smoothly onto the pavement.

4.3.5.1.2 Push the wheelchair forward until the rear wheels touch the kerb. Then, continuing the movement, lift at the push handles while moving the wheelchair forwards.

4.3.5.2 Going Up Kerbs Backwards With an Attendant

Please note that for safety's reason we don't recommend using this method.



CAUTION:

- As KM-BT10 is designed for people of significant size and weight, we recommend the attendant to use lift instead of going up and down by stairs.
- Never try to adjust any adjustable parts by yourself, for example, the adjustment of the center-of-gravity, etc.
- Please contact your service dealer or distributor if needed.

5. INSPECTION AND MAINTENANCE

5.1 General Check

- 5.1.1 Check the following items before moving. If you find anything abnormal, visit your KARMA wheelchair dealer for further inspection before using it.
- 5.1.2 Examine the brakes and check for wear, damage and misalignment. The authorized dealer should carry out these actions, such as replacing or adjusting of the brakes.
- 5.1.3 Check that the handgrips are not damaged and securely bonded to the push handles.
- 5.1.4 Check anti-tippers are not damaged and are securely attached.
- 5.1.5 Check that the wheels of the anti-tipper and frame are not damaged and are securely mounted.
- 5.1.6 When the wheelchair has been used for a period of time, the user needs to check whether the bolts and nuts are tight or not.
- 5.1.7 Check all parts for damage or wear and have a qualified technician replace it if necessary.
- 5.1.8 Check all parts for proper adjustment.
- 5.1.9 Inspect the brakes for proper operation.
- 5.1.10 The wheels and tyres should be checked periodically for cracks and wear, and should be replaced by a qualified technician.
- 5.1.11 A qualified technician can be found with an authorized KARMA dealer.



CAUTION:

- Visit a KARMA wheelchair dealer for inspection and maintenance if you find anything abnormal.

5.2 Regular Maintenance Record

In order to make sure that your wheelchair is in good condition, visit your KARMA wheelchair dealer regularly for maintenance and keep records accordingly every six months after purchasing.

A maintenance/service fee may apply.

 SUGGESTION:

- Even if you don't use the vehicle for a long time, the wheelchair should still be maintained regularly.

ITEM	WEEKLY	MONTHLY
GENERAL		
● Wheelchair rolls straight (no excessive drag or pull to one side)		V
FRAME AND CROSS BARS		
● Inspect the frame structure for small cracks/fissures		V
● Inspect for bent frame or cross bars		V
BRAKES		
● Don't interfere with the tyres when rolling		V
● Pivot points free of wear and looseness		V
● Easy to engage	V	
● Prevent the chair from moving when engaged	V	
SEAT & BACKREST		
● Inspect for rips or sagging	V	
● Inspect for loose or broken hardware, such as the frame and etc.		V
CASTERS		
● Inspect the casters for smooth rotation		V
● Inspect the caster for wear in the bearings/mountings and for tyre wear or damage		V
REAR WHEELS		
● Quick-release axles lock properly; lubricate if necessary (applies to quick-release rear wheel only)	V	
● No excessive side movement or binding when lifted and spun		V
● Inspect for cracked, bent or broken spokes	V	

ITEM	WEEKLY	MONTHLY
ARMRESTS		
<ul style="list-style-type: none"> ● Inspect the detachable armrest button for effective locking ● Make sure the armrest detaches and flips back properly 		V V
FOOTRESTS		
<ul style="list-style-type: none"> ● Inspect the footplate height adjustment screws are securely tightened ● Inspect the swing-away footrest release lever for effective locking 		V V
ANTI-TIPPERS		
<ul style="list-style-type: none"> ● Check the anti-tippers are not damaged and are securely attached. 		V
TYRES		
<ul style="list-style-type: none"> ● Inspect for flat spots, cracks and wear. If equipped with pneumatic tyres, check for proper inflation. For KM-BT10, the pneumatic tyre pressure is 35-45 psi (240-310 kPa) ● Check the tyre tread depth is more than 1 mm ● Check the tyre pressure; tyre pressures are specified on the side of the tyre 	V V V	V
PELVIC BELTS		
<ul style="list-style-type: none"> ● Check the pelvic belts are rigidly fixed and have no sharp edges which might make the user's skin torn and bruised. 		V



CAUTION:

- Never disassemble or modify the wheelchair frame structure. Otherwise, injury or damage may occur. This will void the warranty.
- As with any wheelchair, the wheels and tyres should be checked periodically for cracks and wear, and should be replaced. Failure to keep the tyres at the correct pressure will reduce the braking efficiency.

5.3 Adjustment Manual

5.3.1 Seat Height Adjustment

Caster Position

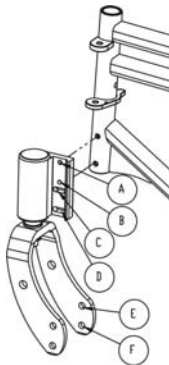

Rear Wheel Position

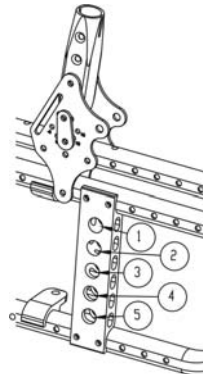

Anti-Tipper Position

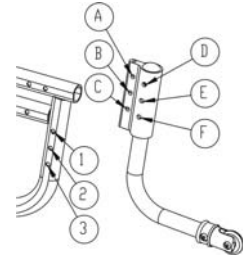

Seat Height	Caster	Rear Wheel	Caster Bracket	Caster Position	Rear Wheel Position	Seat Angle	Anti-Tipper Position
17"	Long Caster Fork 7"x1 3/4	24"x 2.125	(B) (D)	(E)	(2)	2°	(2) (3) / (A) (B) [(D)]
18"	Long Caster Fork 7"x1 3/4	24"x 2.125	(B) (D)	(F)	(2)	4°	(2) (3) / (A) (B) [(E)]
					(3)	2°	
19"	Long Caster Fork 7"x1 3/4	24"x 2.125	(A) (C)	(F)	(3)	4°	(2) (3) / (A) (B) [(F)]
					(4)	2°	
15.5"	Short Caster Fork 7"x1 3/4	20"x 2.125	(B) (D)	(E)	(1)	3°	(1) (2) / (A) (B) [(D)]
16.5"	Short Caster Fork 7"x1 3/4	20"x 2.125	(B) (D)	(F)	(2)	3°	(1) (2) / (A) (B) [(E)]
17.5"	Long Caster Fork 200x50	24"x 2.125	(B) (D)	(E)	(2)	3°	(2) (3) / (A) (B) [(D)]
18.5"	Long Caster Fork 200x50	24"x 2.125	(B) (D)	(F)	(3)	3°	(2) (3) / (A) (B) [(E)]
19.5"	Long Caster Fork 200x50	24"x 2.125	(A) (C)	(F)	(4)	3°	(2) (3) / (A) (B) [(F)]

5.3.2. Seat Depth and Rear Wheel Adjustment

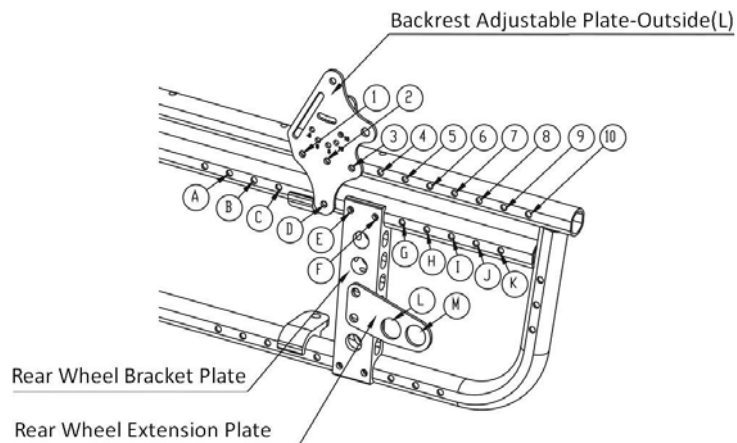

Seat Pan Size 1 :

Seat Depth	Backrest Adjustable Plate-Outside(Left)	Rear Wheel Bracket Plate	
		Active Position	Stable Position
18"	① . ③ . ④	【A B】 or 【B C】	【D E】 or 【E F】
20"	③ . ⑤ . ⑥	【D E】 or 【E F】	【F G】 or 【G H】

Seat Pan Size 2 :

Seat Depth	Backrest Adjustable Plate-Outside(Left)	Rear Wheel Bracket Plate	
		Active Position	Stable Position
22"	⑤ . ⑦ . ⑧	【F G】 or 【G H】	【H I】
24"	⑦ . ⑨ . ⑩	【H I】	【H I】 with anti-tipper assembly (Lengthened) + additional rear wheel extension plates L and M

Note : Below parts are required when the wheelchair is equipped with Rear Wheel Extension Plate.

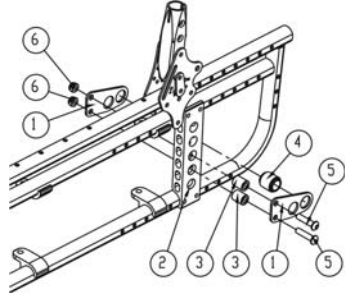
	Part Description	Specifications	Q'ty	
1	Rear Wheel Extension Plate	85.5*48*3t	2	
2	Rear Wheel Bracket Plate	172*38*20	1	
3	Bushing	φ15.8*φ8.1*19.8L	2	
4	Shoulder Bushing	φ12*φ15.9*26L	1	
5	Button Head Socket Cap Screw	M8*P1.25*35L-black	2	
6	Nylon Insert Hex Nut	M8*P1.25-black	2	

5.3.3. Seat Width Adjustment

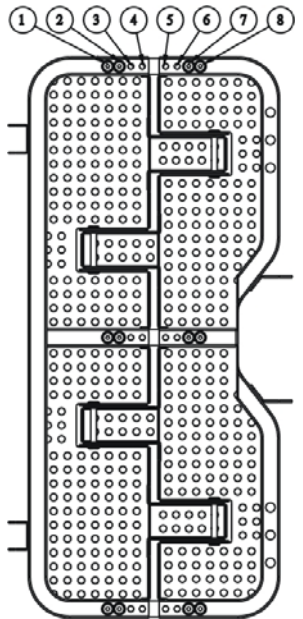
Seat Width \ Seat Depth	22"	24"	26"	
18" or 20"	① . ② or ⑦ . ⑧	② . ③ or ⑥ . ⑦	③ . ④ or ⑤ . ⑥	
Seat Width \ Seat Depth	26"	28"	30"	
22" or 24"	① . ② or ⑦ . ⑧	② . ③ or ⑥ . ⑦	③ . ④ or ⑤ . ⑥	

Note : Seat width adjustment also requires the change of cross bars.

Seat Pan Size 1 :

Wheelchair with seat depth of 18" and 20" share the same spec of seat pan, with adjustable seat width of 22", 24" and 26".

Seat Pan Size 2 :

Wheelchair with seat depth of 22" and 24" share the same spec of seat

pan, with adjustable seat width of 26", 28" and 30".

5.3.4. Backrest Height Adjustment

Range Back Height Set At	16"~18"	18"~20"	
16"	① . ② . ③ . ⑤ Ⓐ . Ⓑ . Ⓒ . Ⓓ		
17"	② . ③ . ④ Ⓐ . Ⓑ . Ⓒ		
18"	③ . ④ Ⓐ . Ⓑ	① . ② . ③ . ⑤ Ⓐ . Ⓑ . Ⓒ . Ⓓ	
19"		② . ③ . ④ Ⓐ . Ⓑ . Ⓒ	
20"		③ . ④ Ⓐ . Ⓑ	

5.3.5. Backrest Angle Adjustment

- Loosen screws 1 , 2 and remove plate 3.
- Adjust the backrest to the desired angle.
(specified on the backrest plate.)
- Put screw 1 back to the hole corresponding to the desired angle and align the plate 3 to the angle. Then tighten screw 1 and 2.
- Repeat the above steps on the other side to complete the adjustment.

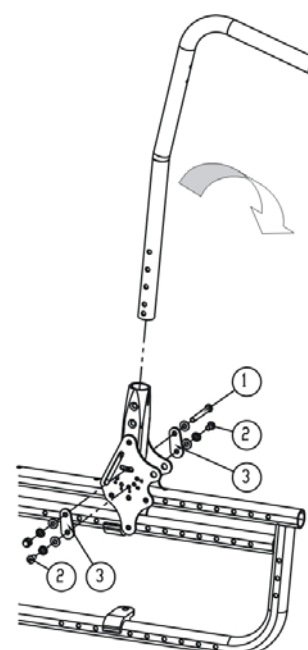

6. ACCESSORIES

	
<ul style="list-style-type: none"> ● I.V. Pole Holder <ul style="list-style-type: none"> - Height adjusts from 130cm (51") to 200cm (78"). 	<ul style="list-style-type: none"> ● Oxygen Tank Holder <ul style="list-style-type: none"> - Standard size attaches to the back of wheelchairs. - Attaches to all KARMA manual wheelchairs.
	
<ul style="list-style-type: none"> ● Folding Drink Holder <ul style="list-style-type: none"> - Collapses and adjusts to the size of the container (6-10 cm). - Attaches to all KARMA manual wheelchairs. 	<ul style="list-style-type: none"> ● Seat Cushion <ul style="list-style-type: none"> - Seat Height 7.5 cm (3")



CAUTION:

- Attaching accessories may alter the overall stability and the centre-of-gravity of the chair. Thus, this should be performed by an authorized dealer/ technician or qualified therapist.

7. TROUBLESHOOTING

You can inspect the following steps before taking your wheelchair to a KARMA wheelchair dealer.

Problem	Checking Points and Corrective Action
Chair Veers Right/Left	<ul style="list-style-type: none">● Check the tyres for correct and equal pressure● Check the caster bracket angle● Check that rear wheels are equally spaced from the seat frame
Sluggish Turn or Performance	<ul style="list-style-type: none">● Check the tyres for correct and equal pressure● Check for loose nuts and bolts
Caster Flutters/Wobbles	<ul style="list-style-type: none">● Check the tyres for correct and equal pressure● Check for loose nuts and bolts● Check the caster bracket angle
Squeaks and Rattles	<ul style="list-style-type: none">● Check for loose nuts and bolts
Looseness in Chair	<ul style="list-style-type: none">● Check for loose nuts and bolts

If you cannot solve the problem by yourself, contact your KARMA wheelchair dealer for help.

8. SPECIFICATIONS

DESCRIPTION \ MODEL	KM-BT10	
Overall Length (mm)	Min.1180	Max.1230
Overall Width (mm)	Min.780	Max.980
Overall Height (mm)	Min.800	Max.1010
Total Weight (kg)	31	
Seat Width (mm)	560/610/660/710/760	
Seat Depth (mm)	460/510/560/610	
Seat Height (mm)	390~500	
Backrest Height (mm)	410~510	
Armrest Height (mm)	250	
Backrest angle	(-5)°~15°	
Calf Length (mm)	320-370	
Rear Tire (Inch)	24Q	
Caster (Inch)	7" / 8"	
Overall Folded Dimension(mm) L*W*H(mm)	Min.900*440*800	Max.950*440*1010
Maximum User Weight (kg)	250	
Max. Single Piece Weight	22.9	

Please be noted that all the above measurements are based on 26" seat width wheelchair.



CAUTION:

- **DON'T** cross any slope with angle greater than 7 degrees.
- **DON'T** attempt to go down inclines without any assistance, whose angle is greater than 5 degrees.
- **DON'T** stand on the footplate directly, whose limit weight is 100 kg.

9. CLEANING & RECYCLING

9.1 Cleaning

9.1.1 In order to lengthen the life of your wheelchair, it is suggested that you clean the wheelchair periodically (if not daily), especially after it is used in the rain or snow.

9.1.2 If possible, don't use your wheelchair in the conditions as mentioned above.

9.1.3 When getting caught in the rain, try to find a shelter. If you can't find it, keep proceeding to your destination.

9.1.4 Although the frame of your wheelchair is aluminium, some parts, such as screws, nuts and spokes of wheels still get rusted if exposed to the humid environment. Always keep it dry and clean.

9.1.5 Frame

Wipe it with a damp cloth. **DON'T** clean it with any abrasive material.

9.1.6 Upholstery

9.1.6.1 When cleaning the upholstery, use warm water and a mild soap.

9.1.6.2 Upholstery cleaner/ foam can also be used. Other cleaning solvents are excluded.

9.1.3 Storage

Store the wheelchair in a dry place.

9.2 Recycling

9.2.1 Post-Consumer Recycling

9.2.1.1 A post-consumer recycling plan should follow the Environmental Protection Administration's regulations. The items listed below are for reference only as local laws and regulations may vary.

Material	Part Name	Method
Aluminium-alloy	Frame	Recyclable
Plastic	Modular Components	Recyclable
Paper	Owner's Manual	Recyclable

9.2.1.2 There are organizations in many countries you can find on the Internet that will accept used goods for charity. Please search the Internet to help the less fortunate individuals and protect our planet for future generations. If you do not have access to the Internet, please use your local phone directory, ask for operator assistance or go to your local government center for more information. Earth Day is every day.

9.2.1.3 Check with your local recycling center on where and how to recycle your wheelchair as this information varies from region to region.

10. WARRANTY

10.1 Serial Number

To ensure after-sale service and warranty, please record and fill in the serial number which can be found on the frame.

Model	KM-BT10
Serial Number	

10.2 Warranty Policy

10.2.1 Contents and Duration of Warranty

10.2.1.1 Contents of Warranty

- Repair will be provided free of charge if the problems are due to manufacturing or defective components within the warranty period (a repair of this kind will hereafter be called "warranty repair).
- Warranty repairs can be carry out by authorized KARMA wheelchair dealers only.
- KARMA is not responsible for the transportation costs for repair and replacement.
- Replaced parts will be the property of KARMA.

10.2.1.2 Warranty Duration

Please contact your local dealer.

10.2.2 Items Not Covered By Warranty

10.2.2.1 Items Not Covered

The items listed below are not covered:

- Consumable parts such as tyres, front casters, seat cushions, brake shoes or pads, upholstery and seating, braking cable, screws/ bolts and washers, lubricant and grease, etc.
- Those that do not affect the quality and function of the wheelchair such as noise or vibration.
- Wear and tear resulting from usage as well as conditions due to lapse of time (e.g. normal aging and deterioration of paint, and plastic parts, etc).
- Damage due to a lack of maintenance or improper operation and storage.
- Fees resulting from routine inspections, adjustments, lubrication, cleaning and other maintenance.
- Any fees incurred as a result of warranty repair, loss or compensation because of the unavailability of the wheelchair (e.g. telephone use, shipping, car rental, and travel costs, etc).

10.2.2.2 Problems Not Covered

Problems caused by the following reasons are not covered:

- Failure to carry out the regular inspection and maintenance recommended by this owner's manual.
- Improper storage.
- Damage resulted from not following the Operation guidelines as outlined in Section 4 of this owner's manual.
- Problems arising due to lack of inspection and/or maintenance as outlined in Section 5 of this owner's manual.
- Installation or use of parts not manufactured by KARMA.
- Damage or surface corrosion from environmental factors such as airborne fallout (chemicals, tree sap, debris and so on), and natural disasters, etc.
- Abuse or misuse not authorized by KARMA, such as addition, modification, or alteration, etc.

10.2.3 The Responsibilities of the User

The following items are the responsibility of the user:

- 10.2.3.1 Proper use of the wheelchair in accordance with the owner's manual.
- 10.2.3.2 Performance of the regular inspections and maintenance recommended by KARMA.
- 10.2.3.3 Keep a record of wheelchair in the back of this owner's manual.

10.2.4 The Responsibilities of the Dealer

The following items are the responsibility of the dealer:

- 10.2.4.1 Follow the directions in this owner's manual, and educate the wheelchair Owner/User in the safe usage and maintenance of the wheelchair.
- 10.2.4.2 Verify that the conditions of warranty have been met.
- 10.2.4.3 Provide KARMA with relevant warranty information and recommendation for improvements when requested.

10.2.5 Warranty Effectiveness

The warranty form must be completely filled out and stamped by the KARMA wheelchair dealership where the wheelchair was purchased.

10.2.6 Transfer of Warranty Rights

If you purchase a second-hand KARMA wheelchair while it is still in the warranty period, bring the owner's manual and the wheelchair to the dealership where the wheelchair was purchased for registration.

10.2.7 Warranty Form (You May Photocopy This Form)

Full Name:	
Gender:	
Date of Birth:	
Address:	
Model:	
Serial Number:	
Date of Purchase:	

10.2.8. Dealer's Data

Name of the Store:	
Phone Number and Address:	

If you have any suggestions on how to improve our products, please don't hesitate to contact your local dealer to let us know what you think of your wheelchair. Our contact details are on <http://www.KarmaMedical.com> Thank you and enjoy.

karma

National agent:

Sold and serviced by:

KARMA MEDICAL PRODUCTS CO., LTD.

[Http://www.KarmaMedical.com](http://www.KarmaMedical.com)

E-mail:globalsales@karma.com.tw

KARMA reserves the right to modify information herein without further notice.