



USER MANUAL

Stealth Products[®]

Lateral and Trunk Support



The World's Best Laterals

Stealth's User Manual and Maintenance Guide for
The World's Best Laterals

Stealth Products strives for 100% customer satisfaction. Your complete satisfaction is important. Please contact us with feedback or suggested changes that will help improve the quality and usability of our products. You may reach us at:



Stealth Products, LLC

104 John Kelly Drive, Burnet, TX 78611

Phone: (512) 715-9995

Toll Free: 1(800) 965-9229

Fax: (512) 715-9954

Toll Free: 1(800) 806-1225

info@stealthproducts.com

www.stealthproducts.com



MDSS GmbH

Schiffgraben 41

30175 Hannover, Germany



General

Read and understand all instructions prior to the use of the product. Failure to adhere to instructions and warnings in this document may result in property damage, injury, or death. Product misuse due to failure of the following instructions will void the warranty.

Immediately discontinue use if any function is compromised, parts are missing, loose, or shows signs of excessive wear. Consult with your supplier for repair, adjustment, or replacement.

Important Information!

All persons responsible for fitting, adjustment, and daily use of the devices discussed in these instructions must be familiar with and understand all safety aspects of the devices mentioned. In order for our products to be used successfully, you must:

- Read and understand all instructions and warnings.
- Maintain our products according to our instructions on care and maintenance.
- Devices should be installed and adjusted by a trained technician.

Supplier Reference

Supplier: _____

Telephone: _____

Address: _____

Purchase Date: _____

Model: _____

Before you install or begin using this product, it is important that you read and understand the content of these installation and operating instructions. The installation instructions will guide you through the possibilities with The World's Best Laterals.

Instructions are written with the expressed intent of use with standard configurations. They also contain important safety and maintenance information. For further assistance, or more advanced applications, please contact your supplier or Stealth Products at (512) 715-9995 or toll free at 1-800-965-9229.

Always keep the operating instructions in a safe place so they may be referenced as necessary.

All information, pictures, illustrations, and specifications are based on the products information that was available at the time of printing. Pictures and illustrations shown in these instructions are representative examples and are not intended to be exact depictions of the various parts of the product.

Ordering Documentation

You can download additional copies of this User Manual on the Stealth website:

www.stealthproducts.com/gui/docs/?type=usr&

Or Search:

The World's Best Laterals User Manual in the search bar at the top of the page.

Our products are designed, manufactured, and produced to the highest of standards. If any defect in material or workmanship is found, Stealth Products will repair or replace the product at our discretion. Any implied warranty, including the implied warranties of merchantability and fitness for a particular purpose, shall not extend beyond the duration of this warranty. Stealth Products, LLC does not warrant damage due to, but not limited to:

- Misuse, abuse, or misapplication of products.
- Modification or product without written approval from Stealth Products, LLC.
- Any alteration or lack of serial number, where applicable, will automatically void this warranty.
- Stealth Products, LLC is liable for replacement parts only.
- Stealth Products, LLC is not liable for any incurred labor costs.

No person is authorized to alter, extend, or waive the warranties of Stealth Products, LLC.

Stealth Products warrants against failure due to defective materials or workmanship:

Covers: 180 days

Hardware: 5 years

Electronics: 3 years

In Case of Product Failure

In the event of product failure covered by our warranty, please follow the procedures outlined below:



1. Call Stealth at +1 (512) 715-9995 or toll free +1-800-965-9229.
2. Request the Returns Department or obtain an RA from the Returns Department and follow department or documentation instructions.

1.0 Customer Satisfaction	i
2.0 Important Information	ii
3.0 Introduction	iii
4.0 Warranty	iv
5.0 Table of Contents	v
6.0 Warning Labels	vi
6.1 Warning Labels	vi
6.2 Limited Liability	vi
6.3 Testing.....	vi
7.0 Functioning	1
7.1 Operating Laterals.....	1
7.2 Adjusting Laterals.....	1
8.0 Mounting	2
8.1 Standard Track Mounting	2
8.2 Standard Cane Mounting.....	2
8.3 Standard Planar Mounting.....	3
8.4 All Season Mounting.....	3
8.5 Full Surface Contact Mounting	4
8.6 Tru Comfort Mounting	4
9.0 First Time Use	5
9.1 Dealer Assistance.....	5
9.2 User Testing	5
9.3 Conditions of Use	5
10.0 Maintenance	6
10.1 Cleaning.....	6
10.2 Maintenance	6

Warning Labels

6.1

Warnings are included for the safety of the user, client, operator and property. Please read and understand what the signal words **SAFETY, NOTICE, CAUTION, WARNING** and **DANGER** mean, how they could affect the user, those around the user, and property.

 DANGER	Identifies an imminent situation which (if not avoided) will result in severe injury, death, and property damage.
 WARNING	Identifies a potential situation which (if not avoided) will result in severe injury, death, and property damage.
 CAUTION	Identifies a potential situation which (if not avoided) will result in minor to moderate injury, and property damage.
NOTICE	Identifies important information not related to injury, but possible property damage.
SAFETY	Indicates steps or instructions for safe practices, reminders of safe procedures, or important safety equipment that may be necessary.

Limited Liability

6.2

Stealth Products, LLC accepts no liability for personal injury or damage to property that may arise from the failure of the user or other persons to follow the recommendations, warnings, and instructions in this manual.

Testing

6.3

Initial setup should be done in an open area free of obstacles until the user is fully capable of driving safely.

The World's Best Laterals should be adjusted with the user in the chair in order to promote the best position and maximum comfort for the client.

Operating Laterals

7.1

To operate the laterals:

1. Depress the quick release button (A).
2. The lateral will swing away 180° into an open-locked position.
3. Depress quick release button again to return swing away arm to the closed-locked position.



Adjusting Adductors

7.2

Standard laterals offer three points of adjustment.

To adjust angles (B) and (C):

1. Lightly loosen 1/4-20 x 1" screws.
2. Set desired angles and retighten screws with 3/16 T-Handle. Do not overtighten.

To adjust pad height:

1. Loosen 1/4-20 x 5/8" Button Head Screws (D).
2. Slide the pad into the desired position.
3. Retighten screws. Do not overtighten.

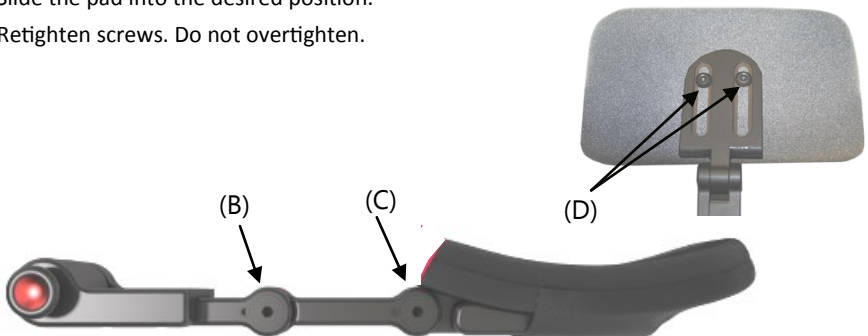

Standard Track Mounting

8.1

To adjust standard track mounting:

1. Insert the 1/4 20x 3/4 Socket Head Screws (E) through the counter bore holes (F) and into the threaded holes of the Universal Track Nut (G).
2. Tighten with a 3/16 T-Handle.

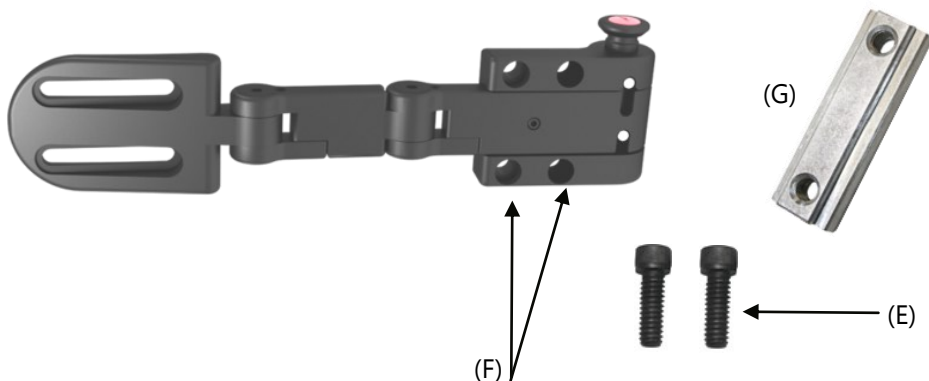

Standard Cane Mounting

8.2

To adjust standard cane mounting:

1. Insert the 1/4-20 x 3/4 Socket Head Screws (H) into the male tube clamp through the counter bore holes and into the female side of the tube clamp.
2. Attach lateral by using 1/4-20 x 3/4 Socket Head Screws and mounting directly to the cane clamp.
3. Tighten with a 3/16 T-Handle.

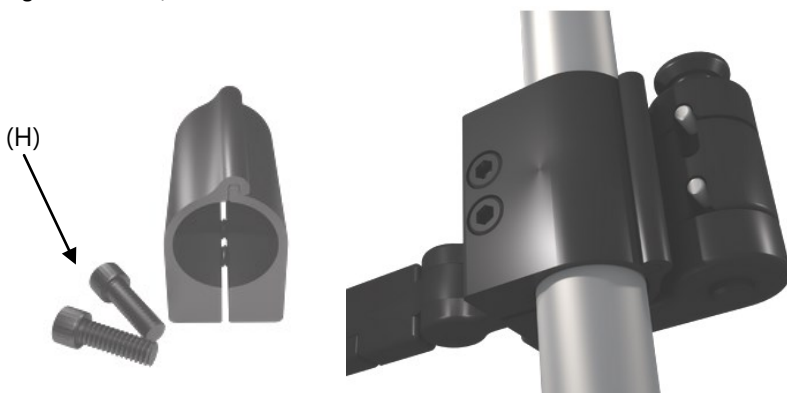

Standard Planar Mounting

8.3

To install planar mounts:

1. Use 1/4-20 x 5/8 Socket Head Screws (A) to mount on the base of the planar mount to the interior of the lateral.
2. Screw the 1/4-20 x 5/8 Button Head Screws (B) through the slots on the planar mount onto the mounting hardware on the chair.
3. Tighten with 3/16 T-Handle.



All Season Mounting

8.4

To install the All Season Mounts:

1. Attach the All Season Bracket to the chair by using the 1/4-20 x 1/2" Flat Head Screws (A). Tighten with 5/32 T- Handle.
2. Use the 1/4-20 x 3/4 Socket Head Screws (B) to directly mount the All Season Bracket.
3. Press down on the red button (C) to make lateral adjustments.

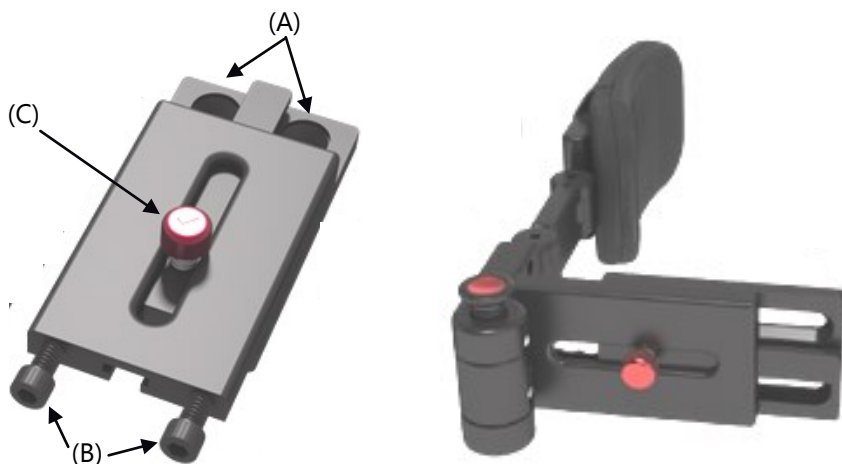

Full Surface Contact Mounting

8.5

The Full Surface Contact mounts are pre-assembled before they are delivered.

To adjust the angle of the pad mount:

1. Loosen the 10-32 x 1/2" Socket Head Screws (A) with a 3/16 T-Handle.
2. Adjust pad mount to desired angle and retighten screws.



Tru Comfort Mounting

8.6

To install Tru Comfort mounts:

1. Secure lateral to the outside of the bracket by using the 1/4-20 x 3/8" Button Head Screws (A).
2. Tighten with 3/16 T-Handle.

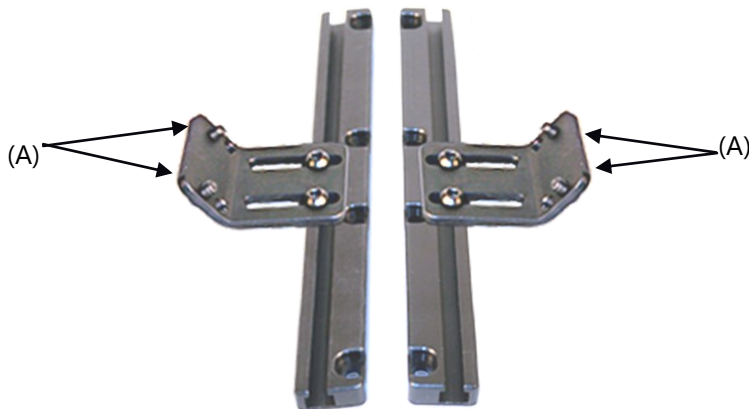

Dealer Assistance

9.1

During first time use by the client, it is advised that the dealer or service technician assists and explain the configuration to the customer (the user and/or the attendant). If needed, the dealer can make final adjustments.

WARNING

The laterals should only be fitted by a qualified healthcare professional.

User Testing

9.2

It is important that the customer is fully aware of the installation and how the laterals can be adjusted in order to gain the best positioning possible. As a dealer, proceed as follows:

- Explain and show the customer how you have executed the installation, and explain the function.

Have the user test the position of the laterals:

- Are the laterals in the proper position for the client?
- Can the user safely operate the chair in the position they are seated in?
- Is the placement of each of the laterals in an optimal position for the user?

If needed, adjust the lateral to the proper position.

Explain to the customer any possible issues and how to address them.

Conditions of Use

9.3

The World's Best Laterals are intended for use as installed by the dealer, in accordance to the installation instructions in this manual:

- The foreseen conditions of use are communicated by the dealer or service technician to the user and/or attendant during the first time use.
- If the conditions of use change significantly, please contact your dealer or a qualified service technician to avoid excessive wear and tear or unintended damage.

Cleaning

10.1

To wash the covers of the laterals:

- Remove the pad/cover from the laterals.
- Machine wash in cold water on delicate cycle and drip dry.

To wash sheepskin covers:

- Remove the cover from the laterals.
- Machine wash in cold water on delicate cycle (or dry clean), and dry.

**WARNING**

Do not use bleach.

**WARNING**

Do not iron

Maintenance

10.2

- Periodically check the hardware for loose screws or worn areas
- Check the pad/cover for any breakdown
- Gently remove dust and dirt with a damp cloth

SAFETY

Replace or repair parts as needed.



Stealth Products, LLC. • info@stealthproducts.com • www.stealthproducts.com
+1(800) 965-9229 | +1(512) 715-9995 | 104 John Kelly Drive, Burnet TX 78611